



MOON
DECOR
PORTOFINO

CONTEMPORARY
COLLECTIONS

LISTINO PREZZI
PRICE LIST

2023

modo 10[®]
ITALIA

ESSENZE E MANIGLIE
ESSENCES AND HANDLES

MOON / DECOR / PORTOFINO COLLEZIONI COLLECTIONS
FRASSINO - ASHWOOD



LATTE



PERLA



FUMO

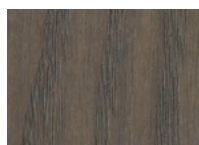

CENERE

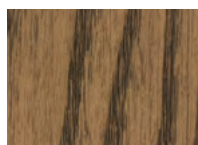

CASTAGNA

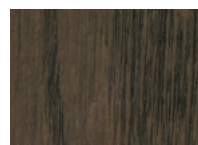

SIGARO

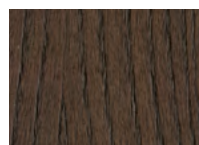

CHINOTTO

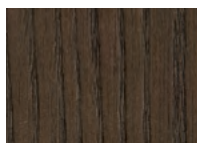

LIQUIRIZIA



TERRACOTTA



BIANCO OPACO E LUCIDO
GLOSSY AND MATT

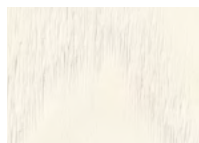

CERA OPACO E LUCIDO
GLOSSY AND MATT

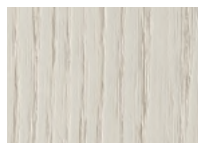

POMICE OPACO E LUCIDO
GLOSSY AND MATT



SABBIA OPACO E LUCIDO
GLOSSY AND MATT



CANAPA OPACO E LUCIDO
GLOSSY AND MATT

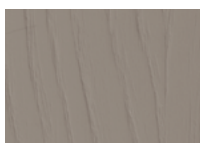

TITANIO OPACO E LUCIDO
GLOSSY AND MATT

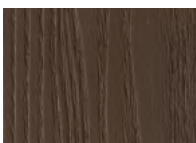

BRUNO OPACO E LUCIDO
GLOSSY AND MATT

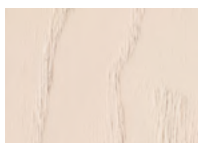

CIPRIA OPACO E LUCIDO
GLOSSY AND MATT

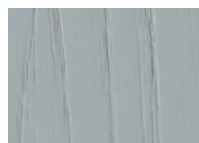

CIELO OPACO E LUCIDO
GLOSSY AND MATT

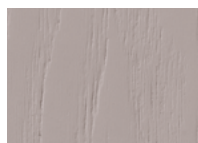

TORTORA OPACO E LUCIDO
GLOSSY AND MATT



ALGA OPACO E LUCIDO
GLOSSY AND MATT



MARASCA OPACO E LUCIDO
GLOSSY AND MATT

FRASSINO FINITURA OLIO
OIL FINISH ASHWOOD



GRIGIO OLIO

FRASSINO VERNICIATO
PAINTED ASHWOOD

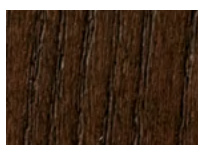

TABACCO

DECOR / PORTOFINO COLLEZIONI COLLECTIONS
NOCE - WALNUT



NATURA



ARGILLA

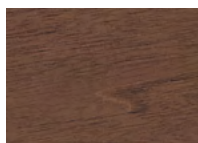

SIENA



AMBRA

MOON / DECOR / PORTOFINO COLLEZIONI COLLECTIONS
FINITURE INTERNI ARMADI | INTERNAL WARDROBES FINISHES



DI SERIE PER ARMADI SCORREVOLE
 MOON, DECOR E PORTOFINO
 STANDARD FOR MOON, DECOR AND
 PORTOFINO SLIDING-DOOR WARDROBES

DECORATIVO OLMO SBIANCATO



DI SERIE PER ARMADI
 BATTENTI PORTOFINO
 STANDARD FOR PORTOFINO
 HINGED-DOOR WARDROBES

FRASSINO ACACIA

DECOR / PORTOFINO COLLEZIONI COLLECTIONS
FINITURE SU METALLO PER PIEDI E MANIGLIE - OPTIONAL
METAL FINISHES FOR FEET AND HANDLES - OPTIONAL

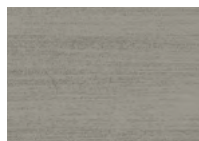

NICHEL SPAZZOLATO
BRUSHED **NICKEL**



BRONZO SPAZZOLATO
BRUSHED **BRONZE**

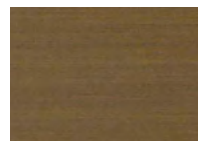

OTTONE BRUNITO
BURNISHED **BRASS**

DECOR / PORTOFINO COLLEZIONI COLLECTIONS

MANIGLIA | HANDLE "RABBIT"
 NICKEL LUCIDO | GLOSSY NICKEL



DIM. IN CM.: L. 14 H. 3.5



DIM. IN CM.: L. 15.8 H. 4.5

MANIGLIA | HANDLE "CINGHIETTA"
 NICKEL SATINATO | SATINIZED NICKEL



DIM. : L. 11,5 H. 2,5 CM



DIM. : L. 15 H. 2,5 CM

MANIGLIA | HANDLE "CUORE"
 NICKEL LUCIDO | GLOSSY NICKEL



DIM. : L. 10 H. 4,1 CM

MANIGLIA | HANDLE "MONDRIAN"

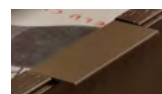

LACCATO ABBINATO AL COLORE DEL MOBILE
 LACQUERED COLOUR TO MATCH THE FINISH
 OF THE FURNITURE DIM. : L. 12 CM

modo 10[®]
ITALIA

MOON - MOONLIGHT NOTTE E GIORNO

MOON - MOONLIGHT NIGHT AND DAY

CARATTERISTICHE TECNICHE TECHNICAL CHARACTERISTICS	4
LETTI BEDS	14
ARMADI WARDROBES	16
COMODINI E COMÒ BEDSIDE TABLES AND CHEST OF DRAWERS	20
CREDENZE E SPECCHIERE SIDEBOARDS AND MIRRORS	21
TAVOLI E SEDIE TABLES AND CHAIRS	22
DIVANI E POLTRONE SOFAS AND ARMCHAIRS	23

MOON NOTTE - NIGHT

CARATTERISTICHE TECNICHE TECHNICAL CHARACTERISTICS

LETTI BEDS

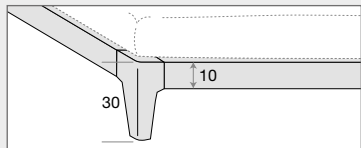

GIROLETTO LEGNO IN PANNELLO LISTELLARE RIVESTITO FRASSINO – PIEDE IN MASSELLO FRASSINO

WOODEN BED SURROUND IN BLOCKBOARD PANEL COVERED IN ASHWOOD – FOOT IN SOLID ASHWOOD H. 6 CM

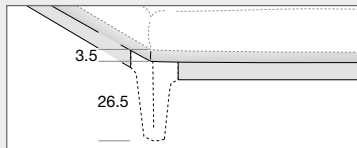

GIROLETTO LEGNO E IMBOTTITO IN PANNELLO DI LISTELLARE FRASSINO E IMBOTTITO IN GOMMAPIUMA E RIVESTITO CON TESSUTI DA CAMPIONARIO – PIEDE IN MASSELLO DI FRASSINO

WOODEN BED SURROUND AND UPHOLSTERED IN ASHWOOD BLOCKBOARD PANEL AND UPHOLSTERED IN FOAM RUBBER AND COVERED WITH SAMPLE FABRICS – FOOT IN SOLID ASHWOOD

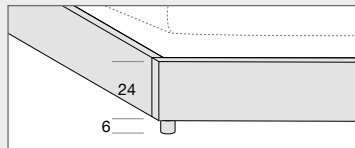

GIROLETTO LEGNO IN PANNELLO LISTELLARE FRASSINO PIEDE IN PLASTICA H. 6 CM

WOODEN BED SURROUND IN BLOCKBOARD ASHWOOD PANEL – FOOT IN PLASTIC H. 6 CM

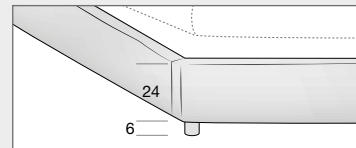

GIROLETTO IMBOTTITO STRUTTURA IN MULTISTRATO, IMBOTTITO IN GOMMAPIUMA E RIVESTITO CON TESSUTI DA CAMPIONARIO – PIEDE IN PLASTICA H. 6 CM

UPHOLSTERED BED SURROUND WITH STRUCTURE IN MULTILAYER, UPHOLSTERED IN FOAM RUBBER AND COVERED WITH SAMPLE FABRICS – FOOT IN PLASTIC H. 6 CM

ALBA

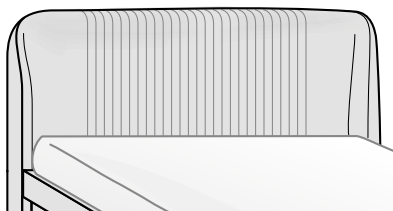

TESTATA IMBOTTITA CON LAVORAZIONE PLISSÉ
UPHOLSTERED PANEL WORKED WITH PLISSÉ

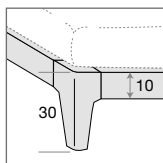

GIROLETTO LEGNO
WOODEN BED SURROUND

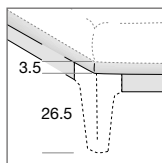

GIROLETTO LEGNO E IMBOTTITO
WOODEN BED SURROUND AND UPHOLSTERED BLOCKBOARD

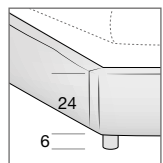

GIROLETTO IMBOTTITO
UPHOLSTERED BED SURROUND

TESTIERA IMBOTTITA

TESTIERA STRUTTURA IN MULTISTRATO DI PIOPPO DA 3 CM.

RIVESTIMENTO TESSUTI E PELLI DA CAMPIONARIO CON LAVORAZIONE PLISSÉ

UPHOLSTERED PANEL

HEADBOARD STRUCTURE IN 3 CM POPLAR MULTILAYER

UPHOLSTERY FABRICS AND LEATHER FROM SAMPLES WITH PLISSÉ PROCESSING

DIMENSIONI TESTIERE HEADBOARD DIMENSIONS

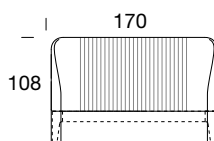

L.160

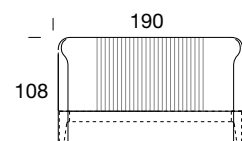

L.180

MOON

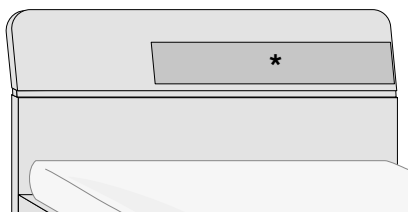

PANNELLO LEGNO
WOODEN PANEL

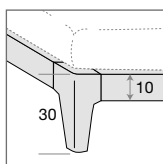

GIROLETTO LEGNO
WOODEN BED SURROUND

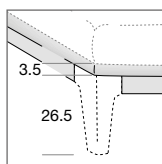

GIROLETTO LEGNO E IMBOTTITO
WOODEN BED SURROUND AND UPHOLSTERED BLOCKBOARD

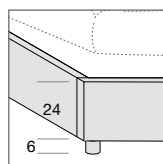

GIROLETTO LEGNO
WOODEN BED SURROUND

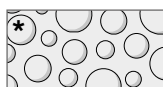

DECORO CERCHIO
CIRCLE DECORATION



DECORO GEOMETRICO
GEOMETRIC DECORATION

PANNELLO LEGNO

TESTIERA IN LISTELLARE IMPIALLACCIATO FRASSINO
DECORO A SCELTA TRA "CERCHIO" O "GEOMETRICO"

DECORO PANNELLO DI MULTISTRATO MASSELLO DI FRASSINO

WOODEN PANEL

HEADBOARD IN ASHWOOD BLOCKBOARD PANEL
CHOICE BETWEEN "CIRCLE" OR "GEOMETRIC" DECORATION

DECORATION SOLID ASWOOD MULTILAYER PANEL

DIMENSIONI TESTIERE HEADBOARD DIMENSIONS

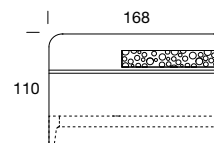

L.160

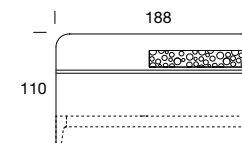

L.180

CARATTERISTICHE TECNICHE
TECHNICAL CHARACTERISTICS

LETTI
BEDS

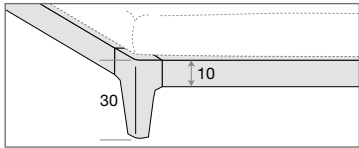

GIROLETTO LEGNO IN PANNELLO LISTELLARE RIVESTITO FRASSINO – PIEDE IN MASSELLO FRASSINO
WOODEN BED SURROUND IN BLOCKBOARD PANEL COVERED IN ASHWOOD – FOOT IN SOLID ASHWOOD H. 6 CM

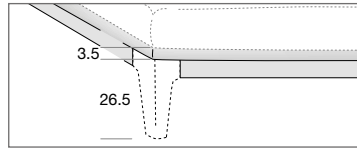

GIROLETTO LEGNO E IMBOTTITO IN PANNELLO DI LISTELLARE FRASSINO E IMBOTTITO IN GOMMAPIUMA E RIVESTITO CON TESSUTI DA CAMPIONARIO – PIEDE IN MASSELLO DI FRASSINO
WOODEN BED SURROUND AND UPHOLSTERED IN ASHWOOD BLOCKBOARD PANEL AND UPHOLSTERED IN FOAM RUBBER AND COVERED WITH SAMPLE FABRICS – FOOT IN SOLID ASHWOOD

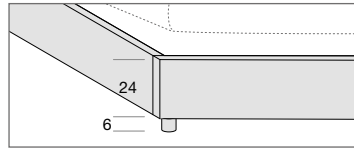

GIROLETTO LEGNO IN PANNELLO LISTELLARE FRASSINO PIEDE IN PLASTICA H. 6 CM
WOODEN BED SURROUND IN BLOCKBOARD ASHWOOD PANEL – FOOT IN PLASTIC H. 6 CM

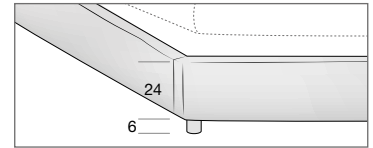

GIROLETTO IMBOTTITO STRUTTURA IN MULTISTRATO, IMBOTTITO IN GOMMAPIUMA E RIVESTITO CON TESSUTI DA CAMPIONARIO – PIEDE IN PLASTICA H. 6 CM
UPHOLSTERED BED SURROUND WITH STRUCTURE IN MULTILAYER, UPHOLSTERED IN FOAM RUBBER AND COVERED WITH SAMPLE FABRICS – FOOT IN PLASTIC H. 6 CM

HONEY



PANNELLO IMBOTTITO
UPHOLSTERED PANEL

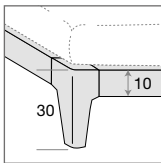

GIROLETTO LEGNO
WOODEN BED SURROUND

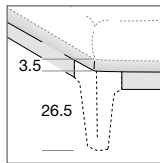

GIROLETTO LEGNO E IMBOTTITO
WOODEN BED SURROUND AND UPHOLSTERED BLOCKBOARD

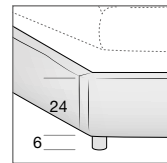

GIROLETTO IMBOTTITO
UPHOLSTERED BED SURROUND

PANNELLO IMBOTTITO

TESTIERA STRUTTURA IN LISTELLARE IMPIALLACCIATO FRASSINO E PANNELLO MULTISTRATO PIOPPO IMBOTTITO IN GOMMAPIUMA E RIVESTITO CON TESSUTI DA CAMPIONARIO

UPHOLSTERED PANEL

HEADBOARD IN BLOCKBOARD PANEL COVERED IN ASHWOOD AND POPLAR MULTILAYER PANEL UPHOLSTERED IN FOAM RUBBER COVERED WITH SAMPLE FABRICS

DIMENSIONI TESTIERE
HEADBOARD DIMENSIONS

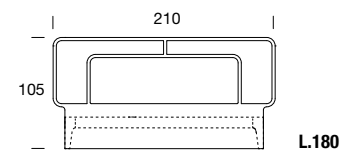
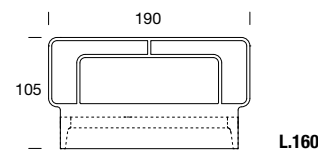

NUVOLA

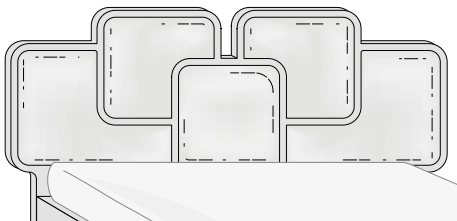

PANNELLO IMBOTTITO
UPHOLSTERED PANEL

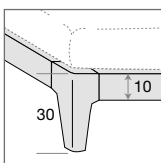

GIROLETTO LEGNO
WOODEN BED SURROUND

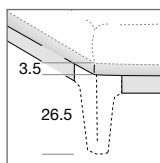

GIROLETTO LEGNO E IMBOTTITO
WOODEN BED SURROUND AND UPHOLSTERED BLOCKBOARD

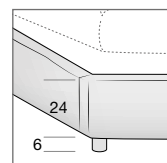

GIROLETTO IMBOTTITO
UPHOLSTERED BED SURROUND

PANNELLO IMBOTTITO

TESTIERA STRUTTURA IN LISTELLARE IMPIALLACCIATO FRASSINO E PANNELLO MULTISTRATO PIOPPO IMBOTTITO IN GOMMAPIUMA E RIVESTITO CON TESSUTI DA CAMPIONARIO

UPHOLSTERED PANEL

HEADBOARD IN BLOCKBOARD PANEL COVERED IN ASHWOOD AND POPLAR MULTILAYER PANEL UPHOLSTERED IN FOAM RUBBER COVERED WITH SAMPLE FABRICS

DIMENSIONI TESTIERE
HEADBOARD DIMENSIONS

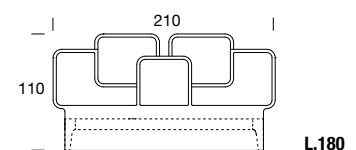
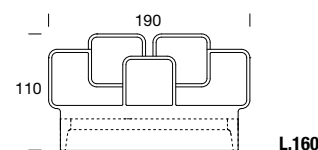

COMODINO, COMÒ E CASSETTIERA

BEDSIDE TABLE, CHEST OF DRAWERS AND DRAWERS UNIT

COMODINO 2 CASSETTI BEDSIDE TABLE WITH 2 DRAWERS

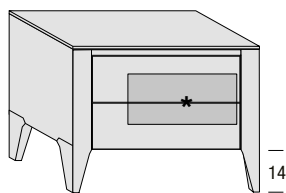

APERTURA PUSH-PULL
PUSH-PULL OPENING



DECORO CERCHIO
CIRCLE DECORATION



DECORO GEOMETRICO
GEOMETRIC DECORATION

COMÒ 3 CASSETTI CHEST OF DRAWERS WITH 3 DRAWERS

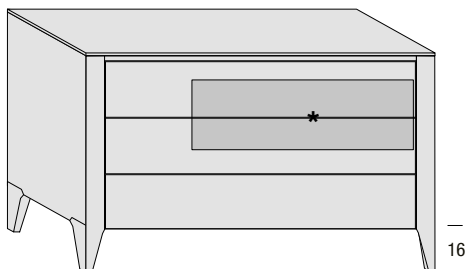

APERTURA PUSH-PULL
PUSH-PULL OPENING



DECORO CERCHIO
CIRCLE DECORATION



DECORO GEOMETRICO
GEOMETRIC DECORATION

CASSETTIERA 5 CASSETTI DRAWERS UNIT WITH 5 DRAWERS

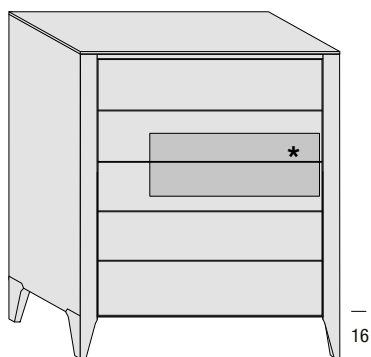

APERTURA PUSH-PULL
PUSH-PULL OPENING



DECORO CERCHIO
CIRCLE DECORATION



DECORO GEOMETRICO
GEOMETRIC DECORATION

COMODINO, COMÒ E CASSETTIERA

STRUTTURA ESTERNA	PANNELLO DI LISTELLARE IMPIALLACCIATO FRASSINO
STRUTTURA INTERNA	PANNELLO DI MULTISTRATO PIOPPO
TOP	PANNELLO DI MULTISTRATO FRASSINO SP. 0,8 CM
GAMBA LATERALE	MASSELLO DI FRASSINO
FRONTALE CASSETTI	PANNELLO DI LISTELLARE IMPIALLACCITO FRASSINO
DECORO	PANNELLO DI MULTISTRATO MASSELLO DI FRASSINO
CASSETTI	STRUTTURA IN PANNELLO DI MULTISTRATI BETULLA, FONDO CASSETTO MULTISTRATI IMPIALLACCIATO FRASSINO
SPALLE	IN LEGNO FJ RIVESTITO FRASSINO SEZIONE 60/70X25.
SCHIENALE	PANNELLO DI MULTISTRATO PIOPPO.
GUIDE	PUSH PULL REGOLABILI IN ALTEZZA

BEDSIDE TABLE, CHEST OF DRAWERS AND DRAWERS UNIT

OUTSIDE STRUCTURE	BLOCKBOARD PANEL COVERED IN ASHWOOD
INSIDE STRUCTURE	POPLAR MULTILAYER PANEL
TOP	BLOCKBOARD PANEL IN ASHWOOD
BACK SIDE LEG	SOLID ASWOOD
WOODEN DRAWER	BLOCKBOARD PANLE COVERED IN ASHWOOD
DECORATION	SOLID ASWOOD MULTILAYER PANEL
DRAWER	STRUCTURE IN MULTILAYER BIRCH PANEL, DRAWER BOTTOM IN MULTILAYER ASHWOOD
SUPPORT PANELS	FJ WOOD COVERED IN ASHWOOD 60/70X25 SECTION.
BACK PANEL	MULTILAYER PANEL IN POPLAR
GUIDES	HEIGHT ADJUSTABLE SOFT-CLOSE GUIDES

CARATTERISTICHE TECNICHE
TECHNICAL CHARACTERISTICS

COMODINO, COMÒ
BEDSIDE TABLE, CHEST OF DRAWERS

COMODINO 2 CASSETTI
BEDSIDE TABLE WITH 2 DRAWERS

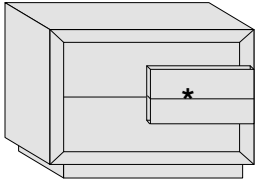

APERTURA CON MANIGLIA IN LEGNO
WOODEN HANDLE OPENING

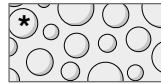

DECORO CERCHIO
CIRCLE DECORATION



DECORO GEOMETRICO
GEOMETRIC DECORATION

COMÒ 3 CASSETTI
CHEST OF DRAWERS WITH 3 DRAWERS

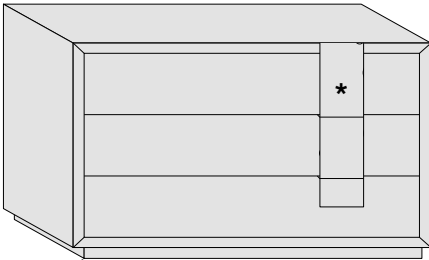

APERTURA CON MANIGLIA IN LEGNO
WOODEN HANDLE OPENING

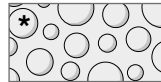

DECORO CERCHIO
CIRCLE DECORATION



DECORO GEOMETRICO
GEOMETRIC DECORATION

COMODINO e COMÒ

STRUTTURA ESTERNA PANNELLO DI LISTELLARE IMPIALLACCIATO FRASSINO

STRUTTURA INTERNA PANNELLO DI MULTISTRATO PIOPPO

FRONTALE CASSETTI PANNELLO DI LISTELLARE IMPIALLACCITO FRASSINO

DECORO PANNELLO DI MULTISTRATO MASSELLO DI FRASSINO

CASSETTI STRUTTURA IN PANNELLO DI MULTISTRATI BETULLA, FONDO CASSETTO MULTISTRATI IMPIALLACCIATO FRASSINO

SCHIENALE PANNELLO DI MULTISTRATO DI PIOPPO

BEDSIDE TABLE AND CHEST OF DRAWERS

OUTSIDE STRUCTURE BLOCKBOARD PANEL COVERED IN ASHWOOD

INSIDE STRUCTURE POPLAR MULTILAYER PANEL

WOODEN DRAWER BLOCKBOARD PANLE COVERED IN ASHWOOD

DECORATION SOLID ASWOOD MULTILAYER PANEL

DRAWER STRUCTURE IN MULTILAYER BIRCH PANEL, DRAWER BOTTOM IN MULTILAYER ASHWOOD

BACK PANEL MULTILAYER PANEL IN POPLAR

MOON NOTTE - NIGHT

CARATTERISTICHE TECNICHE TECHNICAL CHARACTERISTICS

ARMADI ANTE SCORREVOLI E BATTENTI

CAPPELLO, FONDO E FIANCO DIVISORIO PANNELLO DI PARTICELLE DI LEGNO RIVESTITO SU 2 LATI IN DECORATIVO OLMO SBIANCATO SP. 2,5 CM

FIANCO ESTERNO PANNELLO IN LEGNO CON TELAIO IN ABETE DI SP. CM. 3 IMPIALLACCIATO ESTERNAMENTE IN FRASSINO VERNICIATO ED INTERNAMENTE IN DECORATIVO 'OLMO SBIANCATO'

RIPIANO PANNELLO DI PARTICELLE DI LEGNO RIVESTITO SU 2 LATI IN DECORATIVO OLMO SBIANCATO SP. 2,5 CM E BORDO FRONTALE SP. 3,6 CM

SCHIENALE PANNELLO DI MDF IMPIALLACCIATO IN DECORATIVO

CASSETTIERA 3 CASSETTI (OPTIONAL) FONDO E FIANCHI IN PANNELLO DECORATIVO, FRONTALE E STRUTTURA CASSETTI IN PARTICELLE DI LEGNO, FRONTALE CASSETTO IN PANNELLO DECORATIVO. I CASSETTI SCORRONO SU GUIDE A SCOMPARSA AD ESTRAZIONE PARZIALE. - RIPIANO COPRI CASSETTIERA IN PANNELLO DI PARTICELLE DI LEGNO IMPIALLACCIATO IN DECORATIVO.

SLIDING AND HINGED DOORS WARDROBES

TOP AND BOTTOM PANEL PANEL OF WOOD PARTICLES VENEERED 2 SIDES IN DECORATIVE "OLMO SBIANCATO" TH. 2.5 CM

OUTSIDE SIDE PANEL WOOD PANEL WITH FIR FRAME TH. CM. 3, OUTSIDE VENEERED IN PAINTED TANGANICA WALNUT AND INSIDE IN DECORATIVE.

SHELF PANEL OF WOOD PARTICLES COVERED ON 2 SIDES IN DECORATIVE 'OLMO SBIANCATO' TH. 2.5 CM AND FRONT EDGE TH. 3.6 CM

BACK PANEL MDF PANEL VENEERED IN DECORATIVE

DRAWER UNIT SHELF BOTTOM AND SIDE IN DECORATIVE PANEL, DRAWER STRUCTURE AND FRONT IN WOOD PARTICLE, DRAWER FRONT IN DECORATIVE PANEL. DRAWERS RUN ON PARTIAL EXTRACTION CONCEALED GUIDES. - DRAWER UNIT SHELF IN WOOD PARTICLE BOARD PANEL VENEERED IN DECORATIVE.

MOON SCORREVOLE - SLIDING DOORS

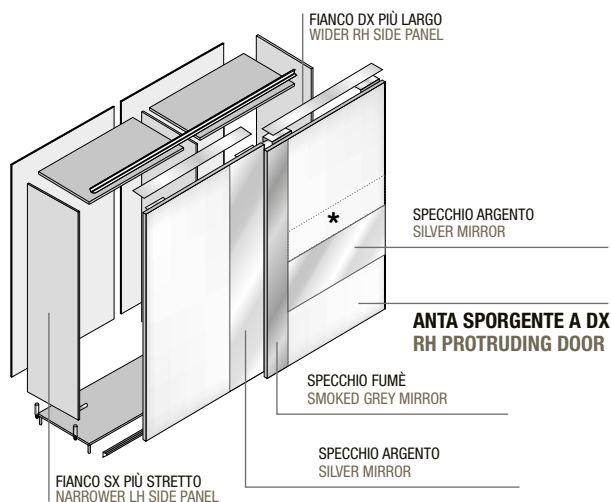

ARMADIO MOON 2 ANTE SCORREVOLI

ANTE PANNELLO IN LEGNO CON TELAIO IN ABETE E MULTISTRATI PIOPPO VERNICIATO ALL' ACQUA. SPECCHIO ARGENTO E FUMÈ, CON POSSIBILITÀ DI INSERIMENTO DECORO IN MASSELLO DI FRASSINO AL POSTO DELLO SPECCHIO ORIZZONTALE.

DECORO PANNELLO DI MULTISTRATO MASSELLO DI FRASSINO

APERTURA MANIGLIA LATERALE IN ZAMA VERNICIATO NICHEL LUCIDO

MOON WARDROBE WITH 2 SLIDING DOORS

DOORS WOOD PANEL WITH FIR FRAME AND MULTILAYER OF POPLAR WATER PAINTED. SILVER AND SMOKED GREY MIRROR, WITH THE POSSIBILITY TO INSERT THE DECORATION IN SOLID ASHWOOD INSTEAD OF HORIZONTAL MIRROR.

DECORATION SOLID ASWOOD MULTILAYER PANEL

OPENING LATERAL HANDLE IN ZAMAK PAINTED POLISHED NICKEL OR BRONZE.



MOON BATTENTE - HINGED DOORS

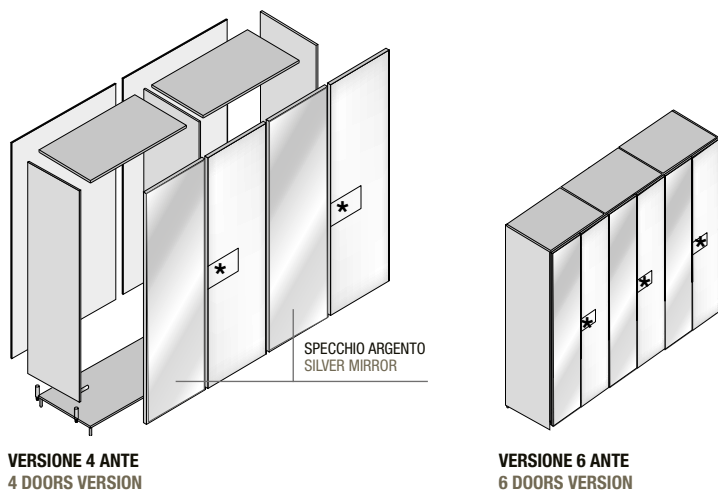

ARMADIO MOON 4/6 ANTE BATTENTI

ANTE PANNELLO IN LEGNO CON TELAIO IN ABETE E COPERTINE IN MDF IMPIALLACCIATO FRASSINO, VERNICIATO ALL' ACQUA. SPECCHIO ARGENTO.

DECORO PANNELLO DI MULTISTRATO MASSELLO DI FRASSINO

APERTURA MANIGLIA IN MASSELLO DI FRASSINO E DECORI IN BASSORILIEVO

MOON WARDROBE WITH 4/6 HINGED DOORS

DOORS WOOD PANEL WITH FIR FRAME AND MDF COVERS ASH VENEER, WATER VARNISHED. SILVER MIRROR.

DECORATION SOLID ASWOOD MULTILAYER PANEL

OPENING SOLID ASH HANDLE AND BAS-RELIEF DECORATIONS



VEGAS

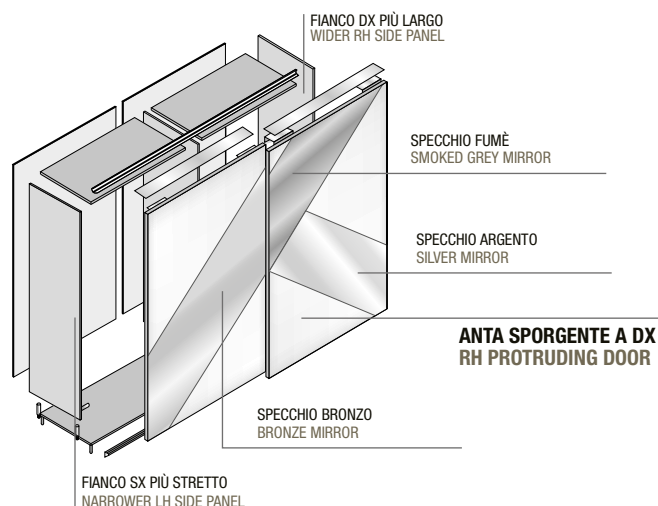

ARMADIO VEGAS 2 ANTE SCORREVOLI

ANTE PANNELLO FRONTALE DI MULTISTRATI IMPIALLACCIATO FRASSINO SP. 0,8 CM E STRUTTURA IN LISTELLARE DI NOCE TANGANICA DA CM 1,8. VERNICIATO ALL' ACQUA. SPECCHIO ARGENTO, BRONZO E FUMÈ.

APERTURA MANIGLIA LATERALE IN ZAMA VERNICIATO NICHEL LUCIDO.

VEGAS WARDROBE WITH 2 SLIDING DOORS

DOORS FRONT PANEL IN ASH VENEERED MULTILAYER SP. 0.8 CM AND STRUCTURE IN TANGANICA WALNUT STRUCTURE OF 1.8 CM. WATER PAINTED. SILVER, BRONZE AND SMOKED MIRROR.

OPENING LATERAL HANDLE IN ZAMAK PAINTED POLISHED NICKEL OR BRONZE.

CARATTERISTICHE TECNICHE
TECHNICAL CHARACTERISTICS

ARMADI
WARDROBES

FERRAMENTA PER ARMADI SCORREVOLI
HARDWARE FOR SLIDING WARDROBES

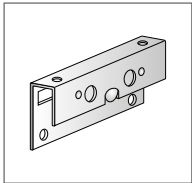

PATINO SUPERIORE PER ANTA INTERNA
TOP RUNNER FOR INTERNAL DOOR

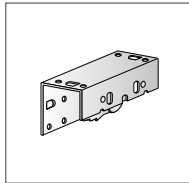

CARRELLO SUPERIORE ANTA
DOOR TOP RUNNER

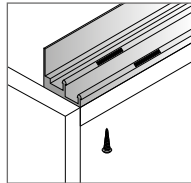

BINARIO SUPERIORE
TOP TRACK

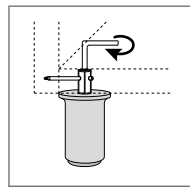

PIEDE REGOLATORE
ADJUSTABLE FOOT

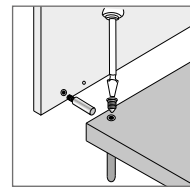

MONTAGGIO PIEDE REGOLATORE
ADJUSTABLE FOOT ASSEMBLY

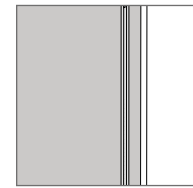

LAMPADA LED (OPTIONAL)
LED LAMP (OPTIONAL)

VANI INTERNI ARMADIO 2 ANTE SCORREVOLI E 4 ANTE BATTENTE
INTERNAL WARDROBE COMPARTMENTS 2 SLIDING DOORS AND 4 HINGED DOORS

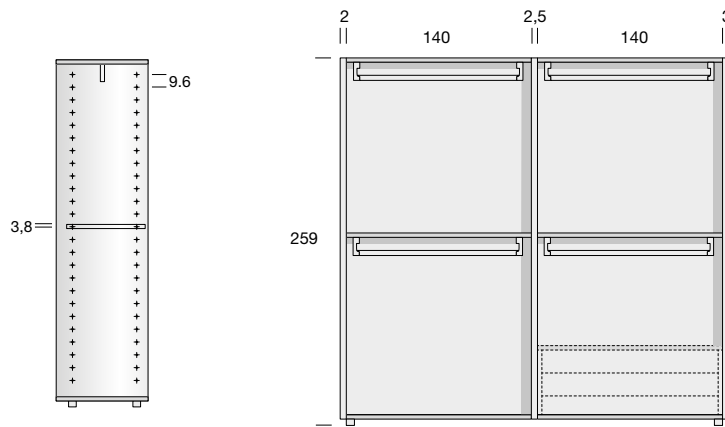

VANI INTERNI ARMADIO 6 ANTE BATTENTE
INTERNAL WARDROBE COMPARTMENTS WITH 6 HINGED DOORS

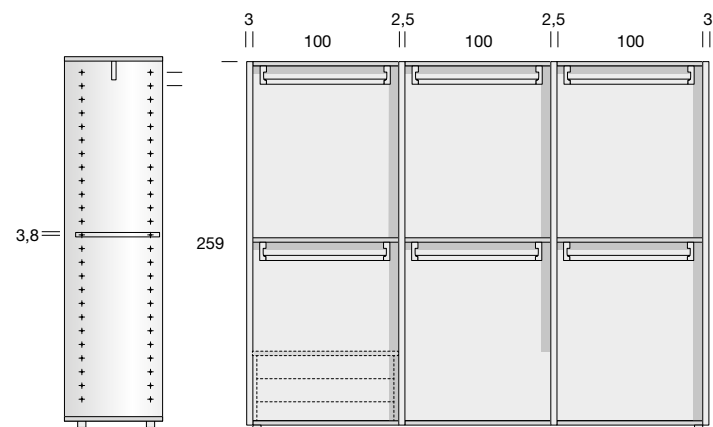

MONTAGGIO ANTE SCORREVOLI ARMADI
ASSEMBLY OF SLIDING WARDROBE DOORS

REGOLAZIONE ANTE PRIMA DEL MONTAGGIO
DOOR ADJUSTMENT BEFORE ASSEMBLY

PRIMA DI PROCEDERE AL MONTAGGIO, BISOGNA REGOLARE LA TENSIONE DELLE ANTE POSIZIONANDOLE OBBLIGATORIAMENTE IN ORIZZONTALE E UTILIZZANDO UN CACCIAVITE O UN PUNTERUOLO.

BEFORE ASSEMBLING REGULATE DOOR TENSION BY PLACING THEM HORIZONTALLY AND USING THE SPECIAL SPANNER PROVIDED.

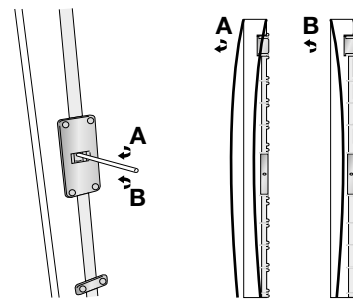

MONTAGGIO ANTE SCORREVOLI
SLIDING DOOR ASSEMBLY

PER POTER AGGANCIARE LE ANTE AL BINARIO SUPERIORE TRA IL SOFFITTO E L'ARMADIO CI DEVONO ESSERE ALMENO 3 CM.

LEAVE AT LEAST 3CM CLEARANCE SO THAT THE DOORS CAN BE ATTACHED TO THE UPPER RAIL BETWEEN THE CEILING AND WARDROBE.

- 1** AGGANCIARE L'ANTA AL BINARIO SUPERIORE
FASTEN THE DOOR TO THE TOP TRACK
- 2** SPINGERE L'ANTA NEL BINARIO INFERIORE
PUSH THE DOOR IN THE LOW TRACK

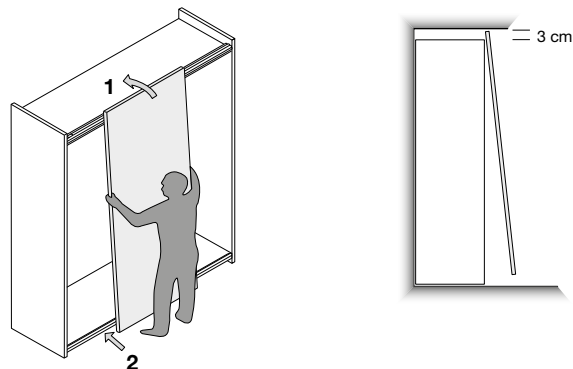

SMONTAGGIO ANTE SCORREVOLI
REMOVAL SLIDING DOORS

PER SBLOCCARE LE ANTE DAL SISTEMA DI BLOCCAGGIO DI SICUREZZA È NECESSARIO AVVITARE IL GRANO (1), LA LINGUETTA (2) SI SPOSTA AUTOMATICAMENTE E SARÀ POSSIBILE SGANCIARE LE ANTE.

TO RELEASE THE DOORS FROM THE SAFETY LOCKING SYSTEM YOU NEED TO TIGHTEN THE SPECIAL SCREW(1), THE TAB (2) AUTOMATICALLY MOVES AND THE DOORS CAN BE RELEASED

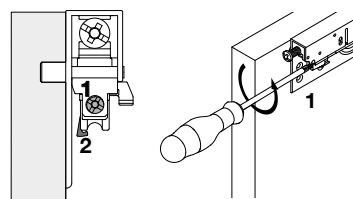

CARATTERISTICHE TECNICHE TECHNICAL CHARACTERISTICS

SPECCHIERE MIRRORS

SFERA / OVALE

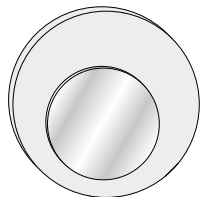

SPECCHIO ARGENTO
SILVER MIRROR



SPECCHIO ARGENTO
SILVER MIRROR

SPECCHIERA SFERA E OVALE

PANNELLO DI LISTELLARE IMPIALLACCIATO FRASSINO E SPECCHIO ARGENTO

SFERA AND OVALE MIRROR

BLOCKBOARD PANEL VENEERED IN AHSWOOD AND SILVER MIRROR

POLTRONA E POUF ARMCHAIR AND POUF

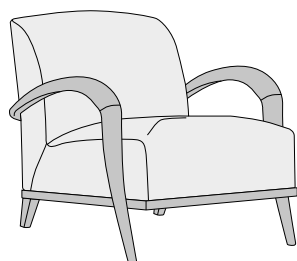

POLTRONA DOMINO

BRACCIOLI E BASE IN MASSELLO DI NOCE CANALETTO.

SEDILE CON CINGHIE, POLIURETANO ESPANSO PF/35, MEMORY, DRACOM DOUPHON, TELA DI COTONE E RIVESTIMENTO DA CAPIONARIO.

SCHIENALE CON POLIURETANO ESPANSO EET/21, MEMORY, DRACOM DOUPHON, TELA DI COTONE E RIVESTIMENTO DA CAPIONARIO.

DOMINO ARMCHAIR

ARMS AND BASE SOLID CANALETTO WALNUT

SEAT WITH BELT, MEMORY, POLYURETHANE FOAM P/F 35, DRACOM DOUPHON, COTTON CANVAS AND COVER SAMPLES

BACK WITH POLYURETHANE FOAM EET/21, MEMORY, DRACOM DOUPHON, COTTON CANVAS AND COVER SAMPLES.

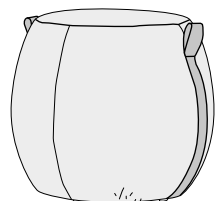

POUF

BASE IN PANNELLO DI MULTISTRATO PIOPPO, POLIURETANO ESPANSO ET/30, FALDA IN RESINATO

CINGHIE IN CUOIO E RIVESTIMENTO CON TESSUTI DA CAMPIONARIO

POUF

BASE IN POPLAR MULTILAYER PANEL, POLYURETHANE FOAM ET/30, RESIN STRATUM

BELT LEATHER AND COVER SAMPLES

CARATTERISTICHE TECNICHE
TECHNICAL CHARACTERISTICS

CREDENZE
SIDEBOARDS

FLY

CREDENZA FLY 2 ANTE
FLY SIDEBOARD WITH 2 DOORS

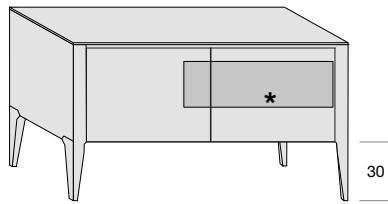

APERTURA: PUSH-PULL
PUSH-PULL OPENING

CREDENZA MOON 3 ANTE
MOON SIDEBOARD WITH 3 DOORS

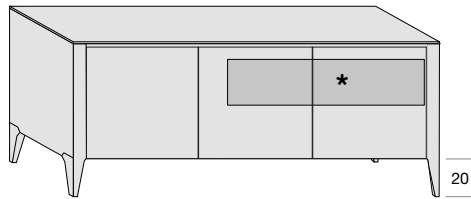

APERTURA: PUSH-PULL
PUSH-PULL OPENING

CREDENZA MOON 3 ANTE E 1 CESTONE
SIDEBOARD WITH 3 DOORS AND 1 BASKET

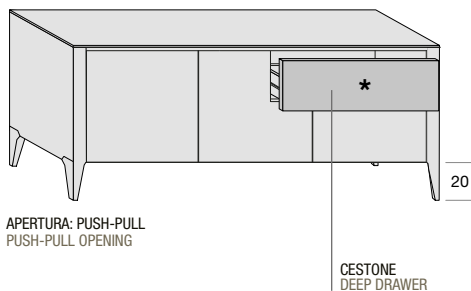

APERTURA: PUSH-PULL
PUSH-PULL OPENING

CESTONE
DEEP DRAWER

MOON

CREDENZE 2 E 3 ANTE

STRUTTURA	IN PANNELLO DI LISTELLARE ESTERNO RIVESTITO IN FRASSINO E INTERNO IN MULTISTRATOPIOPPO
GAMBA LATERALE	MASSELLO DI FRASSINO
SPALLE	IN LEGNO FJ RIVESTITO FRASSINO SEZIONE 60/70X25.
TOP	PANNELLO DI MULTISTRATO FRASSINO
ANTE	IN PANNELLO DI LISTELLARE IMPIALLACCIATO FRASSINO 2 LATI
DECORO	PANNELLO DI MULTISTRATO MASSELLO DI FRASSINO
SCHIENALE	IN MULTISTRATO DI PIOPPO
RIPIANI INTERNI	VETRO

SIDEBOARD WITH 2 AND 3 DOORS

STRUCTURE	BLOCKBOARD PANEL OUTSIDE COVERED IN ASHWOOD, INSIDE COVERED IN MULTILAYER OF POPLAR
BACK SIDE LEG	BLOCKBOARD PANEL COVERED IN ASWOOD
SUPPORT PANELS	FJ WOOD COVERED IN ASHWOOD 60/70X25 SECTION.
TOP	PANEL OF ASHWOOD MULTILAYER
DOORS	BLOCKBOARD PANEL COVERED IN ASHWOOD ON 2 SIDES
DECORATION	SOLID ASHWOOD MULTILAYER PANEL
BACK PANEL	MULTILAYER PANEL IN POPLAR
SHELVES	GLASS INTERNAL SHELVES



DECORO CERCHIO
CIRCLE DECORATION



DECORO GEOMETRICO
GEOMETRIC DECORATION

CREDENZA MOON 3 ANTE E 1 CESTONE

STRUTTURA	IN PANNELLO DI LISTELLARE ESTERNO RIVESTITO IN FRASSINO E INTERNO IN MULTISTRATOPIOPPO
GAMBA LATERALE	MASSELLO DI FRASSINO
SPALLE	IN LEGNO FJ RIVESTITO FRASSINO SEZIONE 60/70X25.
TOP	PANNELLO DI MULTISTRATO FRASSINO
FRONTALI	IN PANNELLO DI LISTELLARE IMPIALLACCIATO FRASSINO 2 LATI
DECORO	PANNELLO DI MULTISTRATO MASSELLO DI FRASSINO
CESTONE	STRUTTURA IN PANNELLO DI MULTISTRATI BETULLA , FONDO CASSETTO MULTISTRATI IMPIALLACCIATO FRASSINO
SCHIENALE	IN MULTISTRATO DI PIOPPO
GUIDE	PUSH PULL REGOLABILI IN ALTEZZA
RIPIANI INTERNI	VETRO

SIDEBOARD WITH 3 DOORS AND 1 BASKET

STRUCTURE	BLOCKBOARD PANEL OUTSIDE COVERED IN ASHWOOD, INSIDE COVERED IN MULTILAYER OF POPLAR
BACK SIDE LEG	BLOCKBOARD PANEL COVERED IN ASWOOD
SUPPORT PANELS	FJ WOOD COVERED IN ASHWOOD 60/70X25 SECTION.
TOP	PANEL OF ASHWOOD MULTILAYER
FRONTS	BLOCKBOARD PANEL COVERED IN ASHWOOD ON 2 SIDES
DECORATION	SOLID ASHWOOD MULTILAYER PANEL
DEEP DRAWER	STRUCTURE IN MULTILAYER BIRCH PANEL, DRAWER BOTTOM IN MULTILAYER ASHWOOD
BACK PANEL	MULTILAYER PANEL IN POPLAR
RUNNER	ADJUSTABLE PUSH PULL FOR HEIGHT
SHELVES	GLASS INTERNAL SHELVES



DECORO CERCHIO
CIRCLE DECORATION



DECORO GEOMETRICO
GEOMETRIC DECORATION

VETRINA E TAVOLO

DISPLAY UNIT AND TABLE

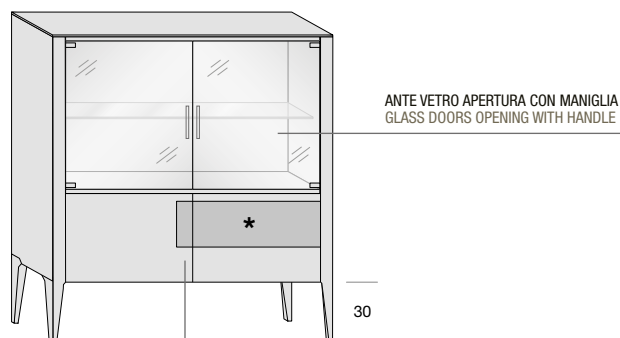

ANTE VETRO APERTURA CON MANIGLIA
GLASS DOORS OPENING WITH HANDLE

APERTURA: PUSH-PULL
PUSH-PULL OPENING

ALTE LEGNO APERTURA PUSH-PULL
WOODEN DOORS WITH PUSH PULL OPENING

VETRINA 2 ANTE LEGNO E 2 ANTE VETRO

STRUTTURA	IN PANNELLO DI LISTELLARE ESTERNO RIVESTITO IN FRASSINO E INTERNO IN MULTISTRATOPIOPPO
GAMBA LATERALE	MASSELLO DI FRASSINO
SPALLE	IN LEGNO FJ RIVESTITO FRASSINO SEZIONE 60/70X25.
TOP	PANNELLO DI MULTISTRATO FRASSINO
ANTE LEGNO	IN PANNELLO DI LISTELLARE IMPIALLACCIATO FRASSINO 2 LATI
DECORO	PANNELLO DI MULTISTRATO MASSELLO DI FRASSINO
ANTE VETRO	VETRO TEMPERATO SP. 0.6 E CERNIERE A MOLLA
SCHIENALE	IN MULTISTRATO DI PIOPPO
RIPIANI INTERNI	VETRO

DISPLAY UNIT WITH 2 WOODEN DOORS AND 2 GLASS DOORS

STRUCTURE	BLOCKBOARD PANEL OUTSIDE COVERED IN ASHWOOD, INSIDE COVERED IN MULTILAYER OF POPLAR
BACK SIDE LEG	BLOCKBOARD PANEL COVERED IN ASWOOD
SUPPORT PANELS	FJ WOOD COVERED IN ASHWOOD 60/70X25 SECTION.
TOP	PANEL OF ASHWOOD MULTILAYER
WOODEN DOORS	BLOCKBOARD PANEL COVERED IN ASHWOOD ON 2 SIDES
DECORATION	SOLID ASWOOD MULTILAYER PANEL
GLASS DOORS	TEMPERED GLASS TH.0.6 AND SPRING HINGES
BACK PANEL	MULTILAYER PANEL IN POPLAR
SHELVES	GLASS INTERNAL SHELVES



DECORO CERCHIO
CIRCLE DECORATION



DECORO GEOMETRICO
GEOMETRIC DECORATION



TAVOLO ALLUNGABILE:
IL PIANO SCORRE LATERALMENTE PER POTER INSERIRE L'ALLUNGA
EXTENDING TABLE
THE TOP SLIDES SIDEWAYS TO ACCOMMODATE THE EXTENSION.

TAVOLO RETTANGOLARE ALLUNGABILE

TOP:	PANNELLO DI PARTICELLE DI LEGNO, IMPIALLACCIATO FRASSINO E BORDATO SP. 2.5
ALLUNGA:	PANNELLO DI LISTELLARE RIVESTITO NOCE CANALETTO E STRUTTURA PERIMETRALE IN MASSELLO DI NOCE CANALETTO SP. 2.5
GAMBE:	LEGNO MASSELLO DI FRASSINO, VERNICIATO
MISURE DISPONIBILI:	160 X 90 CM E 180 X 90 CON ALLUNGA DA 55 CM

RECTANGULAR EXTENDING TABLE

TOP:	WOOD PARTICLE PANEL, ASH VENEER AND EDGED SP. 2.5
EXTENSION:	BLOCKBOARD PANEL COVERED IN CANALETTO WALNUT AND PERIMETRIC STRUCTURE IN SOLID CANALETTO WALNUT TH. 2.5
LEGS:	SOLID ASH WOOD, VARNISHED
AVAILABLE DIM.:	160 X 90 CM E 180 X 90 WITH 1 EXTENSION OF 55 CM

CARATTERISTICHE TECNICHE
TECHNICAL CHARACTERISTICS
SEDIE
CHAIRS
BARCELONA

SEDIA BARCELONA

FUSTO: MASSELLO DI FAGGIO

SEDUTA: PANNELLO IN MULTISTRATI PIOPPO IMBOTTITO IN GOMMAPIUMA E RIVESTITO CON TESSUTI DA CAMPIONARIO

BARCELONA CHAIR

CARCASE: SOLID BEECH

SEAT: POPLAR MULTILAYER PANEL UPHOLSTERED IN FOAM RUBBER AND COVERED WITH SAMPLE FABRICS

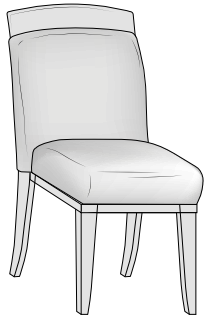
ELLE

SEDIA

FUSTO MASSELLO DI FAGGIO, VERNICIATO O LACCATO.

IMBOTTITURA SEDILE E SCHIENALE IN GOMMAPIUMA E RIVESTIMENTO COME DA CAMPIONARIO

SCHIENALE SUPERIORE MASSELLO IN FRASSINO SPAZZOLATO A PORO APERTO O FAGGIO

CHAIR

CARCASE LACQUERED OR PAINTED BEECH SOLID WOOD.

PADDING BACK PANEL AND SEAT IN FOAM RUBBER AND COVERED IN OUR RANGE FINISHES.

TOP BACK PANEL OPEN PORE BRUSHED SOLID ASHWOOD OR BEECH

MOON NOTTE - NIGHT

LETTI BEDS

LETTO ALBA TESTIERA IMBOTTITA ALBA BED UPHOLSTERED PANEL

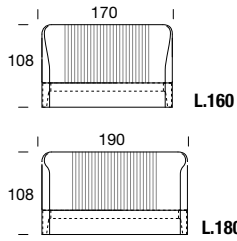

LETTO DA 160 – GIROLETTO LEGNO
160 CM WIDE BED – WOODEN BED SURROUND

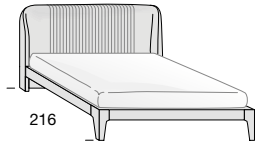

MISURE INTERNE 162x207 PER MATERASSO 160X200
INTERNAL DIMENSIONS 162x207 FOR MATTRESS 160X200

MON5301K		
CAT. A	CAT. B	CAT. C
ECOPELLE/ECONABUK ECOLEATHER/ECONABUK	LINO/VELLUTO LINEN/VELVET	PELLE LEATHER
3.194	3.343	4.741

mc 0,90 – Kg 75

LETTO DA 160 – GIROLETTO LEGNO CON FASCIA
IMBOTTITA
160 CM WIDE BED – WOODEN AND UPHOLSTERED BED
SURROUND

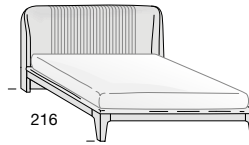

MISURE INTERNE 162x207 PER MATERASSO 160X200
INTERNAL DIMENSIONS 162x207 FOR MATTRESS 160X200

MON5101K		
CAT. A	CAT. B	CAT. C
ECOPELLE/ECONABUK ECOLEATHER/ECONABUK	LINO/VELLUTO LINEN/VELVET	PELLE LEATHER
3.597	3.813	5.315

mc 0,90 – Kg 75

LETTO DA 160 GIROLETTO IMBOTTITO
(CONTENITORE CON RETE BASCULANTE OPTIONAL)
160 CM WIDE BED WITH UPHOLSTERED BED SURROUND
(OPTIONAL BED STORAGE WITH TILTING BED BASE)

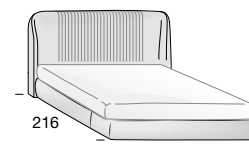

SPAZIO UTILE CONTENITORE H. CM 16 – MISURE INTERNE 170x215
STORAGE USEFUL SPACE H. CM 16 – INTERNAL DIMENSIONS 170x215

MON5701K			OPTIONAL
CAT. A	CAT. B	CAT. C	
ECOPELLE/ECONABUK ECOLEATHER/ECONABUK	LINO/VELLUTO LINEN/VELVET	PELLE LEATHER	BOX CONTENITORE STORAGE BED
3.945	4.087	5.932	+ 680

mc 1,15 – Kg 95

mc 0,40 – Kg 66

LETTO MOON TESTIERA LEGNO CON DECORO MOON BED WOODEN HEADBOARD WITH DECORATION

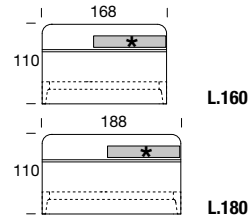
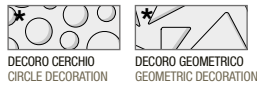

LETTO DA 160 – GIROLETTO LEGNO
160 CM WIDE BED – WOODEN BED SURROUND

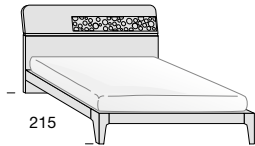

MISURE INTERNE 162X202 PER MATERASSO 160X200
INTERNAL DIMENSIONS 162X202 FOR MATTRESS 160X200

MON5001K		
2.206		

mc 0,55 – Kg 65

LETTO DA 160 GIROLETTO LEGNO E RETE BASCULANTE
160 CM WIDE BED WITH WOODEN BED SURROUND
AND TILTING BED BASE

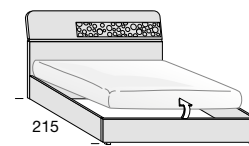

SPAZIO UTILE CONTENITORE H. CM 16 – MISURE INTERNE 162X204
STORAGE USEFUL SPACE H. CM 16 – INTERNAL DIMENSIONS 162X204

MON5401K		
3.288		

mc 0,70 – Kg 85

MAGG. PER DECORO BICOLORE
SURCH. FOR BICOLOR DECORATION **+ 5%**

LETTO HONEY TESTIERA IMBOTTITA HONEY BED UPHOLSTERED PANEL

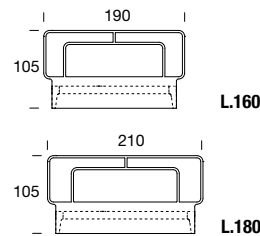

LETTO DA 160 – GIROLETTO LEGNO
160 CM WIDE BED – WOODEN BED SURROUND



MISURE INTERNE 162X202 PER MATERASSO 160X200
INTERNAL DIMENSIONS 162X202 FOR MATTRESS 160X200

MON5201K		
CAT. A	CAT. B	CAT. C
ECOPELLE/ECONABUK ECOLEATHER/ECONABUK	LINO/VELLUTO LINEN/VELVET	PELLE LEATHER
2.614	2.806	3.028

mc 0,55 – Kg 65

LETTO DA 160 – GIROLETTO LEGNO CON FASCIA
IMBOTTITA
160 CM WIDE BED – WOODEN AND UPHOLSTERED BED
SURROUND



MISURE INTERNE 162X202 PER MATERASSO 160X200
INTERNAL DIMENSIONS 162X202 FOR MATTRESS 160X200

MON5801K		
CAT. A	CAT. B	CAT. C
ECOPELLE/ECONABUK ECOLEATHER/ECONABUK	LINO/VELLUTO LINEN/VELVET	PELLE LEATHER
3.010	3.276	3.601

mc 0,55 – Kg 65

LETTO DA 160 GIROLETTO IMBOTTITO
(CONTENITORE CON RETE BASCULANTE OPTIONAL)
160 CM WIDE BED WITH UPHOLSTERED BED SURROUND
(OPTIONAL BED STORAGE WITH TILTING BED BASE)

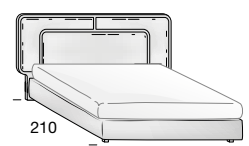

SPAZIO UTILE CONTENITORE H. CM 16 – MISURE INTERNE 162X204
STORAGE USEFUL SPACE H. CM 16 – INTERNAL DIMENSIONS 162X204

MON5601K			OPTIONAL
CAT. A	CAT. B	CAT. C	
ECOPELLE/ECONABUK ECOLEATHER/ECONABUK	LINO/VELLUTO LINEN/VELVET	PELLE LEATHER	BOX CONTENITORE STORAGE BED
3.599	3.857	4.106	+ 680

mc 0,70 – Kg 85

mc 0,40 – Kg 66

LETTO NUVOLA TESTIERA IMBOTTITA NUVOLA BED UPHOLSTERED PANEL

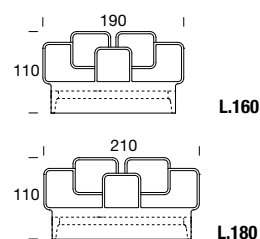

LETTO DA 160 – GIROLETTO LEGNO
160 CM WIDE BED – WOODEN BED SURROUND



MISURE INTERNE 162X202 PER MATERASSO 160X200
INTERNAL DIMENSIONS 162X202 FOR MATTRESS 160X200

MON5111K		
CAT. A	CAT. B	CAT. C
ECOPELLE/ECONABUK ECOLEATHER/ECONABUK	LINO/VELLUTO LINEN/VELVET	PELLE LEATHER
3.139	3.281	3.758

mc 0,55 – Kg 65

LETTO DA 160 – GIROLETTO LEGNO CON FASCIA
IMBOTTITA
160 CM WIDE BED – WOODEN AND UPHOLSTERED BED
SURROUND

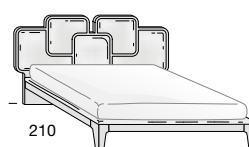

MISURE INTERNE 162X202 PER MATERASSO 160X200
INTERNAL DIMENSIONS 162X202 FOR MATTRESS 160X200

MON5901K		
CAT. A	CAT. B	CAT. C
ECOPELLE/ECONABUK ECOLEATHER/ECONABUK	LINO/VELLUTO LINEN/VELVET	PELLE LEATHER
3.548	3.738	4.331

mc 0,55 – Kg 65

LETTO DA 160 GIROLETTO IMBOTTITO
(CONTENITORE CON RETE BASCULANTE OPTIONAL)
160 CM WIDE BED WITH UPHOLSTERED BED SURROUND
(OPTIONAL BED STORAGE WITH TILTING BED BASE)

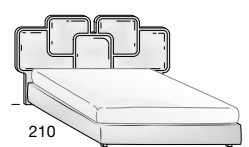

SPAZIO UTILE CONTENITORE H. CM 16 – MISURE INTERNE 162X204
STORAGE USEFUL SPACE H. CM 16 – INTERNAL DIMENSIONS 162X204

MON5511K			OPTIONAL
CAT. A	CAT. B	CAT. C	
ECOPELLE/ECONABUK ECOLEATHER/ECONABUK	LINO/VELLUTO LINEN/VELVET	PELLE LEATHER	BOX CONTENITORE STORAGE BED
2.875	4.327	4.837	+ 680

mc 0,70 – Kg 85

mc 0,40 – Kg 66

FRASSINO / ASHWOOD
Cuscini Multicolor / Multicolor cushions

LETTO DA 180 – GIROLETTO LEGNO
180 CM WIDE BED – WOODEN BED SURROUND



216

MISURE INTERNE 182x207 PER MATERASSO 180X200
INTERNAL DIMENSIONS 182x207 FOR MATTRESS 160X200

MON5302K		
CAT. A	CAT. B	CAT. C
ECOPELLE/ECONABUK ECOLEATHER/ECONABUK	LINO/VELLUTO LINEN/VELVET	PELLE LEATHER
3.454	3.609	4.983

mc 0,95 – Kg 80

**LETTO DA 180 – GIROLETTO LEGNO CON FASCIA
IMBOTTITA**
180 CM WIDE BED – WOODEN AND UPHOLSTERED BED
SURROUND

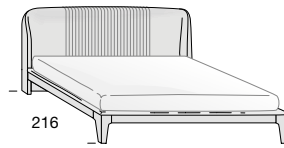

216

MISURE INTERNE 182x207 PER MATERASSO 180X200
INTERNAL DIMENSIONS 182x207 FOR MATTRESS 160X200

MON5102K		
CAT. A	CAT. B	CAT. C
ECOPELLE/ECONABUK ECOLEATHER/ECONABUK	LINO/VELLUTO LINEN/VELVET	PELLE LEATHER
3.862	4.072	5.555

mc 0,95 – Kg 80

LETTO DA 180 GIROLETTO IMBOTTITO
(CONTENITORE CON RETE BASCULANTE OPTIONAL)
180 CM WIDE BED WITH UPHOLSTERED BED SURROUND
(OPTIONAL BED STORAGE WITH TILTING BED BASE)

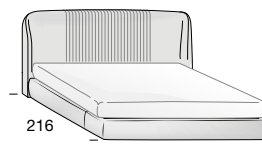

216

SPAZIO UTILE CONTENITORE H. CM 16 – MISURE INTERNE 190x215
STORAGE USEFUL SPACE H. CM 16 – INTERNAL DIMENSIONS 170x215

MON5702K			OPTIONAL
CAT. A	CAT. B	CAT. C	
ECOPELLE/ECONABUK ECOLEATHER/ECONABUK	LINO/VELLUTO LINEN/VELVET	PELLE LEATHER	BOX CONTENITORE STORAGE BED
4.924	5.191	6.098	+ 750

mc 1,40 – Kg 105

mc 0,40 – Kg 66

**MAGGIORAZIONI E RIDUZIONI
SURCHARGES AND REDUCTIONS**

PER LONGHERONI PIÙ LUNGI
O PIÙ CORTI APPLICARE
MAGG. DEL
FOR LONGER OR SHORTER
SIDES PLEASE ADD THE
FOLLOWING EXTRA CHARGE

+ 10%



SOLLEVAMENTO
ORIZZONTALE
HORIZONTAL LIFTING
MECHANISM

+ 222

LETTO DA 180 – GIROLETTO LEGNO
180 CM WIDE BED – WOODEN BED SURROUND



215

MISURE INTERNE 182X202 PER MATERASSO 180X200
INTERNAL DIMENSIONS 182X202 FOR MATTRESS 180X200

MON5002K		
2.477		

mc 0,90 – Kg 75

LETTO DA 180 GIROLETTO LEGNO E RETE BASCULANTE
180 CM WIDE BED WITH WOODEN BED SURROUND
AND TILTING BED BASE

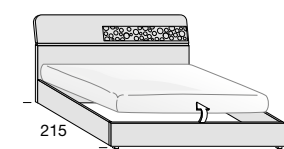

215

SPAZIO UTILE CONTENITORE H. CM 16 – MISURE INTERNE 182X204
STORAGE USEFUL SPACE H. CM 16 – INTERNAL DIMENSIONS 182X204

MON5402K		
3.553		

mc 1,2 – Kg 95

MAGG. PER DECORO BICOLORE
SURCH. FOR BICOLOR DECORATION **+ 5%**

LETTO DA 180 – GIROLETTO LEGNO
180 CM WIDE BED – WOODEN BED SURROUND



210

MISURE INTERNE 182X202 PER MATERASSO 180X200
INTERNAL DIMENSIONS 182X202 FOR MATTRESS 180X200

MON5202K		
CAT. A	CAT. B	CAT. C
ECOPELLE/ECONABUK ECOLEATHER/ECONABUK	LINO/VELLUTO LINEN/VELVET	PELLE LEATHER
2.880	3.078	3.275

mc 0,90 – Kg 75

**LETTO DA 180 – GIROLETTO LEGNO CON FASCIA
IMBOTTITA**
180 CM WIDE BED – WOODEN AND UPHOLSTERED BED
SURROUND



210

MISURE INTERNE 182X202 PER MATERASSO 180X200
INTERNAL DIMENSIONS 182X202 FOR MATTRESS 180X200

MON5802K		
CAT. A	CAT. B	CAT. C
ECOPELLE/ECONABUK ECOLEATHER/ECONABUK	LINO/VELLUTO LINEN/VELVET	PELLE LEATHER
3.281	3.541	3.842

mc 0,90 – Kg 75

LETTO DA 180 GIROLETTO IMBOTTITO
(CONTENITORE CON RETE BASCULANTE OPTIONAL)
180 CM WIDE BED WITH UPHOLSTERED BED SURROUND
(OPTIONAL BED STORAGE WITH TILTING BED BASE)

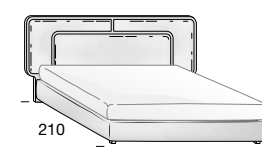

210

SPAZIO UTILE CONTENITORE H. CM 16 – MISURE INTERNE 182X204
STORAGE USEFUL SPACE H. CM 16 – INTERNAL DIMENSIONS 182X204

MON5602K			OPTIONAL
CAT. A	CAT. B	CAT. C	
ECOPELLE/ECONABUK ECOLEATHER/ECONABUK	LINO/VELLUTO LINEN/VELVET	PELLE LEATHER	BOX CONTENITORE STORAGE BED
2.610	4.129	4.278	+ 750

mc 1,2 – Kg 95

mc 0,40 – Kg 66

**RETE A DOGHE
SLATTED BED BASE**

RETE 160x200
PER LETTI DA 160
BED BASE 160x200
FOR 160 CM WIDE BEDS

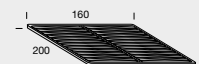

ACS5160K

433

mc 0,09 – Kg 15

RETE 180x200
PER LETTI DA 180
BED BASE 180x200
FOR 180 CM WIDE BEDS



ACS5180K

593

mc 0,10 – Kg 17

LETTO DA 180 – GIROLETTO LEGNO
180 CM WIDE BED – WOODEN BED SURROUND



210

MISURE INTERNE 182X202 PER MATERASSO 180X200
INTERNAL DIMENSIONS 182X202 FOR MATTRESS 180X200

MON5112K		
CAT. A	CAT. B	CAT. C
ECOPELLE/ECONABUK ECOLEATHER/ECONABUK	LINO/VELLUTO LINEN/VELVET	PELLE LEATHER
3.411	3.548	4.000
+ 5 %		

mc 0,90 – Kg 75

**LETTO DA 180 – GIROLETTO LEGNO CON FASCIA
IMBOTTITA**
180 CM WIDE BED – WOODEN AND UPHOLSTERED BED
SURROUND



210

MISURE INTERNE 182X202 PER MATERASSO 180X200
INTERNAL DIMENSIONS 182X202 FOR MATTRESS 180X200

MON5902K		
CAT. A	CAT. B	CAT. C
ECOPELLE/ECONABUK ECOLEATHER/ECONABUK	LINO/VELLUTO LINEN/VELVET	PELLE LEATHER
3.819	4.004	4.573
+ 5 %		

mc 0,90 – Kg 75

LETTO DA 180 GIROLETTO IMBOTTITO
(CONTENITORE CON RETE BASCULANTE OPTIONAL)
180 CM WIDE BED WITH UPHOLSTERED BED SURROUND
(OPTIONAL BED STORAGE WITH TILTING BED BASE)

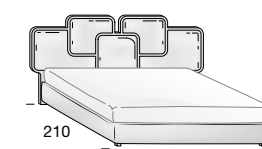

210

SPAZIO UTILE CONTENITORE H. CM 16 – MISURE INTERNE 182X204
STORAGE USEFUL SPACE H. CM 16 – INTERNAL DIMENSIONS 182X204

MON5512K			OPTIONAL
CAT. A	CAT. B	CAT. C	
ECOPELLE/ECONABUK ECOLEATHER/ECONABUK	LINO/VELLUTO LINEN/VELVET	PELLE LEATHER	BOX CONTENITORE STORAGE BED
4.401	4.594	5.008	+ 750
+ 5 %			

mc 1,2 – Kg 95

mc 0,40 – Kg 66

KIT SUPPORTI PER RETI
SINGOLE O RETI MOTORIZZATE
KIT WITH SUPPORTS FOR SINGLE
OR MOTORIZED BED BASE UNIT
WITHS

ACS5191K

235

MOON NOTTE - NIGHT

ARMADI SCORREVOLI SLIDING DOOR WARDROBES

MOON 3 SPECCHI MOON 3 MIRRORS

2 ANTE SCORREVOLI CON 2 SPECCHI VERTICALI E 1 SPECCHIO ORIZZONTALE
SLIDING DOORS WITH 2 VERTICAL MIRRORS AND 1 HORIZONTAL MIRROR

ATTREZZATURA INTERNA:
2 RIPIANI 4 TUBI APPENDIABILI
INTERIOR FITTINGS:
2 SHELVES, 4 CLOTHES HANGING
RAILS

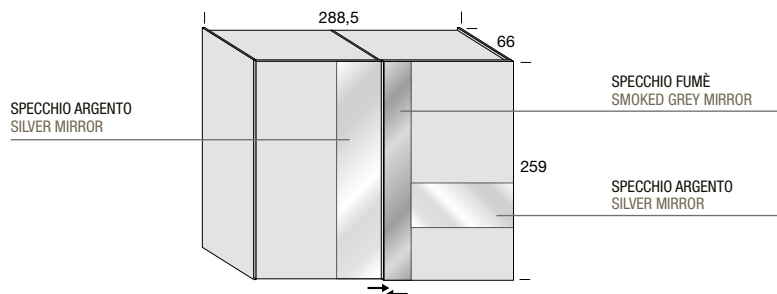

MON8021K	OPTIONAL
	ACS3100K L. 140
4.913	+ 470
mc 1,30 – Kg 130	mc 0,44 – Kg 54

FRASSINO / ASHWOOD

MOON 3 SPECCHI CON DECORO MOON 3 MIRRORS WITH DECORATION

2 ANTE SCORREVOLI CON 2 SPECCHI VERTICALI, 1 SPECCHIO ORIZZONTALE E 1 DECORO ORIZZONTALE
SLIDING DOORS WITH 2 VERTICAL MIRRORS, 2 HORIZONTAL MIRROR AND 1 HORIZONTAL DECORATION

ATTREZZATURA INTERNA:
2 RIPIANI 4 TUBI APPENDIABILI
INTERIOR FITTINGS:
2 SHELVES, 4 CLOTHES HANGING
RAILS

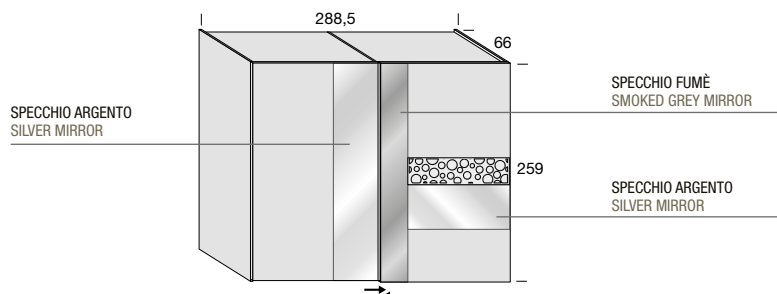

MAGG. PER DECORO BICOLORE
SURCH. FOR BICOLOR DECORATION **+ 266**

MON8001K	OPTIONAL
	ACS3100K L. 140
5.067	+ 470
mc 1,30 – Kg 130	mc 0,44 – Kg 54

FRASSINO / ASHWOOD

ATTREZZATURA INTERNA INTERIOR FITTINGS

DIVISORIO INTERNO SP. 2.5
INTERNAL PARTITIONS TH. 2.5

DIVISORIO INTERNO SP. 2.5
INTERNAL PARTITIONS TH. 2.5

KIT 2 LUCI LED VERTICALI H. 240
KIT FOR 2 VERTICAL LED LIGHTS
H. 240

KIT DI 2 DEPURATORI
D'ARIA CON SISTEMA
AIRLIGHTPRO UV-A
KIT OF 2 PURIFIERS
AIR WITH SYSTEM
AIRLIGHTPRO UV-A

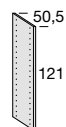
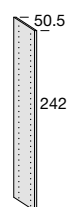

CON SENSORE E TRASFORMATORE (1 DX E 1 SX)
WITH SENSOR AND TRANSFORMER (1 RH AND 1 LH)

PER RICAMBI FILTRI
RIVOLGERSI A:
FOR FILTER SPARE PARTS
CONTACT:
INFO@METALARREDO.IT

ACS1022C	ACS1021C	ACS1080K	ACS1190K	
415	222	637	656	
mc 0,10 – Kg 24	mc 0,05 – Kg 10			

VEGAS

2 ANTE SCORREVOLI CON 3 SPECCHI OBLIQUI
 2 SLIDING DOORS WITH 3 OBLIQUE MIRRORS

**ATTREZZATURA INTERNA:
 2 RIPIANI 4 TUBI APPENDIABILI**
**INTERIOR FITTINGS:
 2 SHELVES, 4 CLOTHES HANGING
 RAILS**

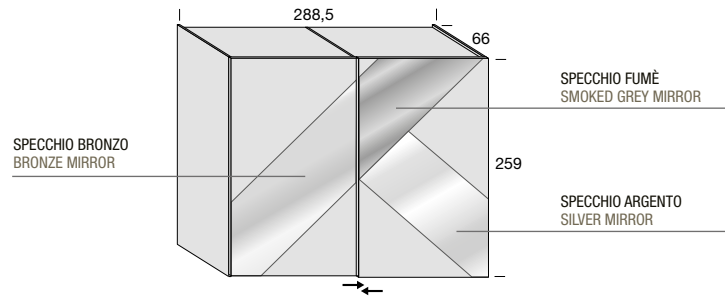

	MON8011K	OPTIONAL	
		ACS3100K L. 140	SPECCHIO - MIRROR 3 SPECCHI UGUALI 3 IDENTICAL MIRRORS
FRASSINO / ASHWOOD	5.642	+ 470	+ 5%
	mc 1,30 – Kg 130	mc 0,44 – Kg 54	

MAGGIORAZIONI E RIDUZIONI SURCHARGES AND REDUCTIONS

RIDUZIONI SINGOLE
 SINGLE ADJUSTMENTS

LUNGHEZZA LENGTH	+ 30%
PROFONDITÀ DEPTH	
ALTEZZA HEIGHT	

RIDUZIONI COMBinate TRA LORO
 COMBINED ADJUSTMENTS

RIDUZIONE DI 2 MISURE REDUCTION OF 2 DIMENSIONS	+ 40%
--	--------------

ES. RIDUZIONE IN LUNGHEZZA +
 PROFONDITÀ O PROFONDITÀ + ALTEZZA ECC.
 EX. OF REDUCTION IN LENGTH +
 DEPTH OR DEPTH + HEIGHT ETC.

* SPECCHI TUTTI E 3 ARGENTO, TUTTI E 3 BRONZO
 O TUTTI E 3 FUMÈ
 ALL 3 SILVER MIRRORS, ALL 3 BRONZE MIRRORS,
 ALL 3 SMOLED GREY MIRRORS

MAGGIORAZIONE PER SCOCCA ARMADIO IN
 PANNELLO DI LEGNO
 INCREASE FOR WARDROBE STRUCTURE IN
 WOODEN PANEL.

+ 532

OPTIONAL OPTIONAL

CASSETTIERA "EASY" 3 CASSETTI
 GUIDE AMMORTIZZATE
 "EASY" DRAWER UNIT WITH 3 DRAWERS
 SOFT-CLOSE GUIDES

RIPIANI AGGIUNTIVI SP. 3,6 CM
 ADDITIONAL SHELVES TH. 3,6 CM



TUBO APPENDIABILI
 CLOTHES HANGING RAILS



ACS1014C	ACS1013C	ACS1012C	ACS1016C	ACS1011C	ACS1104C	ACS1103C	ACS1102C	ACS1106C	ACS1101C
L. 45	L. 70	L. 90	L. 100	L. 140	L. 45	L. 70	L. 90	L. 100	L. 140
136	162	186	229	241	44	44	55	55	55
mc 0,04 – Kg 4	mc 0,05 – Kg 8	mc 0,05 – Kg 11	mc 0,06 – Kg 13	mc 0,07 – Kg 15					

MOON NOTTE - NIGHT

ARMADI BATTENTI HINGED DOOR WARDROBES

MOONLIGHT CON DECORO MOONLIGHT WITH DECORATION

4 ANTE BATTENTE
4 HINGED DOORS

**ATTREZZATURA INTERNA:
2 RIPIANI 4 TUBI APPENDIABILI**
**INTERIOR FITTINGS:
2 SHELVES, 4 CLOTHES HANGING
RAILS**

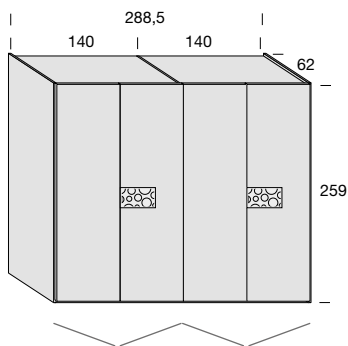

APERTURA 2 MANIGLIE IN LEGNO CON DECORO
OPENING 2 WOODEN HANDLES WITH DECORATION

MON8041K		OPTIONAL	
		ACS3100K L. 140	
		+ 470	
mc 1,30 – Kg 130		mc 0,44 – Kg 54	

FRASSINO / ASHWOOD

MOONLIGHT CON DECORO MOONLIGHT WITH DECORATION

6 ANTE BATTENTE
6 HINGED DOORS

**ATTREZZATURA INTERNA:
3 RIPIANI 6 TUBI APPENDIABILI**
**INTERIOR FITTINGS:
3 SHELVES, 6 CLOTHES HANGING
RAILS**

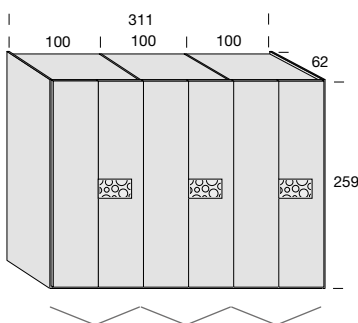
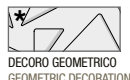

APERTURA 3 MANIGLIE IN LEGNO CON DECORO
OPENING 3 WOODEN HANDLES WITH DECORATION

MON8051K		OPTIONAL	
		ACS3110K L. 100	
		+ 451	
mc 1,50 – Kg 150		mc 0,35 – Kg 45	

FRASSINO / ASHWOOD

ATTREZZATURA INTERNA INTERIOR FITTINGS

DIVISORIO INTERNO SP. 2,5
INTERNAL PARTITIONS TH. 2,5

DIVISORIO INTERNO SP. 2,5
INTERNAL PARTITIONS TH. 2,5

KIT 2 LUCI LED VERTICALI H. 240
KIT FOR 2 VERTICAL LED LIGHTS
H. 240

KIT DI 2 DEPURATORI
D'ARIA CON SISTEMA
AIRLIGHTPRO UV-A
KIT OF 2 PURIFIERS
AIR WITH SYSTEM
AIRLIGHTPRO UV-A

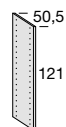
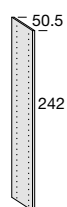

ACS1022C	ACS1021C	ACS1080K	ACS1190K	
415	222	637	656	
mc 0,10 – Kg 24	mc 0,05 – Kg 10			

CON SENSORE E TRASFORMATORE (1 DX E 1 SX)
WITH SENSOR AND TRANSFORMER (1 RH AND 1 LH)

PER RICAMBI FILTRI
RIVOLGERSI A:
FOR FILTER SPARE PARTS
CONTACT:
INFO@METALARREDO.IT

MOONLIGHT 2 SPECCHI CON DECORO

MOONLIGHT 2 MIRRORS WITH DECORATION

ATTREZZATURA INTERNA:
2 RIPIANI 4 TUBI APPENDIABILI
INTERIOR FITTINGS:
2 SHELVES, 4 CLOTHES HANGING RAILS

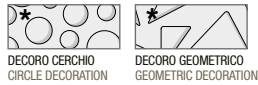

4 ANTE BATTENTE CON 2 SPECCHI VERTICALI
4 HINGED DOORS WITH 2 VERTICAL MIRRORS

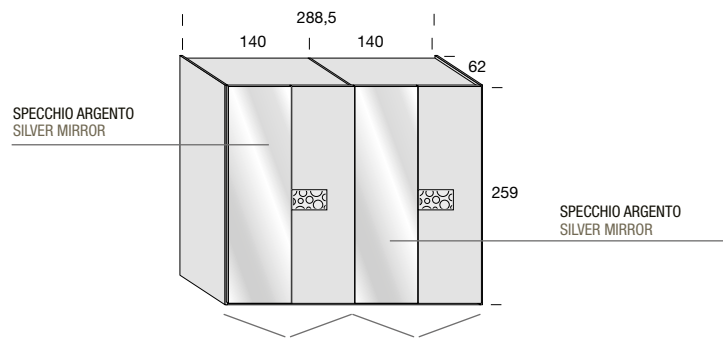

APERTURA 2 MANIGLIE IN LEGNO CON DECORO
OPENING 2 WOODEN HANDLES WITH DECORATION

MON8031K	OPTIONAL
	ACS3100K L. 140
5.196	+ 470
mc 1,30 – Kg 130	mc 0,44 – Kg 54

FRASSINO / ASHWOOD

MOONLIGHT 3 SPECCHI CON DECORO

MOONLIGHT 3 MIRRORS WITH DECORATION

ATTREZZATURA INTERNA:
3 RIPIANI 6 TUBI APPENDIABILI
INTERIOR FITTINGS:
3 SHELVES, 6 CLOTHES HANGING RAILS

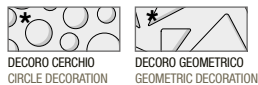

6 ANTE BATTENTE CON 3 SPECCHI VERTICALI
6 HINGED DOORS WITH 3 VERTICAL MIRRORS

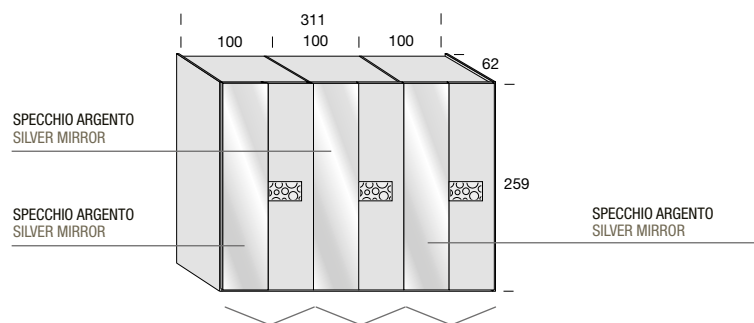

APERTURA 3 MANIGLIE IN LEGNO CON DECORO
OPENING 3 WOODEN HANDLES WITH DECORATION

MON8061K	OPTIONAL
	ACS3110K L. 100
6.457	+ 451
mc 1,50 – Kg 150	mc 0,35 – Kg 45

RIPIANI AGGIUNTIVI SP. 3,6 CM
ADDITIONAL SHELVES TH. 3,6 CM

TUBO APPENDIABILI
CLOTHES HANGING RAILS



MAGGIORAZIONI E RIDUZIONI SURCHARGES AND REDUCTIONS

RIDUZIONI SINGOLE
SINGLE ADJUSTMENTS

LUNGHEZZA LENGTH	+ 30%
PROFONDITÀ DEPTH	
ALTEZZA HEIGHT	

RIDUZIONI COMBinate TRA LORO
COMBINED ADJUSTMENTS

RIDUZIONE DI 2 MISURE REDUCTION OF 2 DIMENSIONS	+ 40%
--	-------

ES. RIDUZIONE IN LUNGHEZZA + PROFONDITÀ O PROFONDITÀ + ALTEZZA ECC.
EX. OF REDUCTION IN LENGTH + DEPTH OR DEPTH + HEIGHT ETC.

OPTIONAL

CASSETTIERA "EASY" 3 CASSETTI GUIDE AMMORTIZZATE
"EASY" DRAWER UNIT WITH 3 DRAWERS SOFT-CLOSE GUIDES

ACS1014C	ACS1013C	ACS1012C	ACS1016C	ACS1011C	ACS1104C	ACS1103C	ACS1102C	ACS1106C	ACS1101C
L. 45	L. 70	L. 90	L. 100	L. 140	L. 45	L. 70	L. 90	L. 100	L. 140
136	162	186	229	241	44	44	55	55	55
mc 0,04 – Kg 4	mc 0,05 – Kg 8	mc 0,05 – Kg 11	mc 0,06 – Kg 13	mc 0,07 – Kg 15					

MOON NOTTE - NIGHT

COMODINO, COMÒ E CASSETTIERA

BEDSIDE TABLE, CHEST OF DRAWERS AND 5-DRAWERS UNIT

COMODINO MOON MOON BEDSIDE TABLE

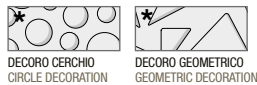

MAGG. PER DECORO BICOLORE
SURCH. FOR BICOLOR DECORATION **+ 5%**

FRASSINO / ASHWOOD

COMODINO 2 CASSETTI SX BEDSIDE TABLE WITH 2 DRAWERS LH

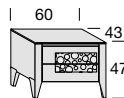

APERTURA PUSH PULL
PUSH PULL OPENING SYSTEM

MON7002K

1.111

mc 0,14 – Kg 40

COMODINO 2 CASSETTI DX BEDSIDE TABLE WITH 2 DRAWERS RH

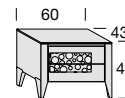

APERTURA PUSH PULL
PUSH PULL OPENING SYSTEM

MON7001K

1.111

mc 0,14 – Kg 40

COMÒ E CASSETTIERA MOON MOON CHEST OF DRAWERS AND 5-DRAWERS UNIT

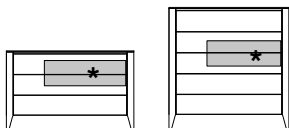
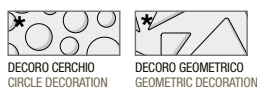

MAGG. PER DECORO BICOLORE
SURCH. FOR BICOLOR DECORATION **+ 5%**

FRASSINO / ASHWOOD

COMÒ 3 CASSETTI 3-DRAWER CHEST

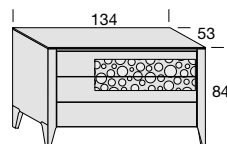

APERTURA PUSH PULL
PUSH PULL OPENING SYSTEM

MON6001K

2.542

mc 0,69 – Kg 70

CASSETTIERA 5 CASSETTI 5-DRAWERS UNIT

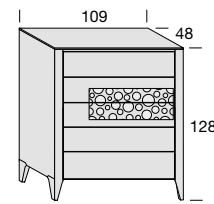

APERTURA PUSH PULL
PUSH PULL OPENING SYSTEM

MON6501K

3.577

mc 0,77 – Kg 85

COMODINO MOONLIGHT MOONLIGHT BEDSIDE TABLE

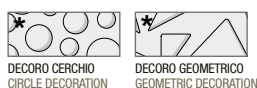

BICOLORE COMPRESO NEL PREZZO
BICOLOR INCLUDED IN THE PRICE

FRASSINO / ASHWOOD

COMODINO 2 CASSETTI SX BEDSIDE TABLE WITH 2 DRAWERS LH

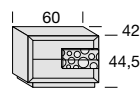

APERTURA MANIGLIA IN LEGNO INTEGRATA
INTEGRATED WOODEN OPENING SYSTEM

MON7702K

982

mc 0,14 – Kg 40

COMODINO 2 CASSETTI DX BEDSIDE TABLE WITH 2 DRAWERS RH

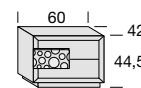

APERTURA MANIGLIA IN LEGNO INTEGRATA
INTEGRATED WOODEN OPENING SYSTEM

MON7701K

982

mc 0,14 – Kg 40

COMÒ MOONLIGHT MOONLIGHT CHEST OF DRAWERS

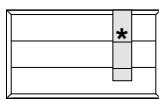
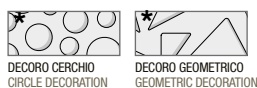

BICOLORE COMPRESO NEL PREZZO
BICOLOR INCLUDED IN THE PRICE

FRASSINO / ASHWOOD

COMÒ 3 CASSETTI 3-DRAWER CHEST

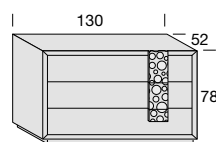

APERTURA MANIGLIA IN LEGNO INTEGRATA
INTEGRATED WOODEN OPENING SYSTEM

MON6601K

2.057

mc 0,69 – Kg 70

MAGGIORAZIONI E RIDUZIONI SURCHARGES AND REDUCTIONS

RIDUZIONI SINGOLE SINGLE ADJUSTMENTS

LUNGHEZZA LENGTH	
PROFONDITÀ DEPTH	+ 30%
ALTEZZA HEIGHT	

RIDUZIONI COMBinate TRA LORO COMBINED ADJUSTMENTS

LUNGHEZZA + PROFONDITÀ LENGTH + DEPTH	+ 40%
--	--------------

PER ULTERIORI MODIFICHE
RICHIEDERE PREVENTIVO
FOR MODIFICATIONS
ASK FOR AN ESTIMATE.

MAGGIORAZIONI E RIDUZIONI SURCHARGES AND REDUCTIONS

RIDUZIONI SINGOLE SINGLE ADJUSTMENTS

LUNGHEZZA LENGTH	
PROFONDITÀ DEPTH	+ 30%
ALTEZZA HEIGHT	

RIDUZIONI COMBinate TRA LORO COMBINED ADJUSTMENTS

LUNGHEZZA + PROFONDITÀ LENGTH + DEPTH	+ 40%
--	--------------

PER ULTERIORI MODIFICHE
RICHIEDERE PREVENTIVO
FOR MODIFICATIONS
ASK FOR AN ESTIMATE.

SPECCHIERE, CREDENZE E VETRINA
MIRRORS, SIDEBOARDS AND DISPLAY UNIT

SPECCHIERE MOON
MOON MIRRORS

SPECCHIERA SFERA
SFERA MIRROR

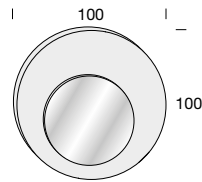

SPECCHIO ARGENTO
SILVER MIRROR

MON9101K

FRASSINO / ASHWOOD

634

mc 0,11 – Kg 15

SPECCHIERA OVALE
OVALE MIRROR

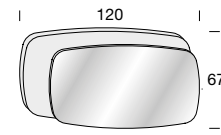

SPECCHIO ARGENTO
SILVER MIRROR

MON9001K

582

mc 0,11 – Kg 15

MAGGIORAZIONI E RIDUZIONI
SURCHARGES AND REDUCTIONS

RIDUZIONI SINGOLE
SINGLE ADJUSTMENTS

LUNGHEZZA LENGTH	
PROFONDITÀ DEPTH	+ 30%
ALTEZZA HEIGHT	

RIDUZIONI COMBinate TRA LORO
COMBINED ADJUSTMENTS

LUNGHEZZA + PROFONDITÀ LENGTH + DEPTH	+ 40%
--	-------

PER ULTERIORI MODIFICHE
RICHIEDERE PREVENTIVO
FOR MODIFICATIONS
ASK FOR AN ESTIMATE.

CREDENZA FLY
FLY SIDEBOARD

CREDENZA 2 ANTE LEGNO
SIDEBOARD 2 WOODEN DOORS

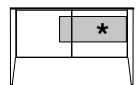
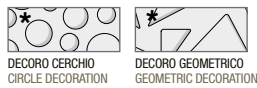

MAGG. PER DECORO BICOLORE
SURCH. FOR BICOLOR DECORATION **+ 5%**

FRASSINO / ASHWOOD

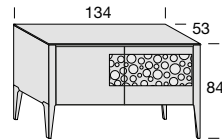

2 RIPIANI VETRO, APERTURA PUSH PULL
2 GLASS SHELVES, PUSH PULL OPENING SYSTEM

MOG2001K

2.614

mc 0,81 – Kg 65

CREDENZE MOON
MOON SIDEBOARDS

CREDENZA 3 ANTE LEGNO
SIDEBOARD 3 WOODEN DOORS

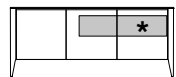
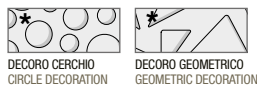

MAGG. PER DECORO BICOLORE
SURCH. FOR BICOLOR DECORATION **+ 5%**

FRASSINO / ASHWOOD

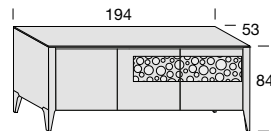

3 RIPIANI VETRO, APERTURA PUSH PULL
3 GLASS SHELVES, PUSH PULL OPENING SYSTEM

MOG2021K

3.114

mc 1,01 – Kg 95

CREDENZA 3 ANTE LEGNO, 1 CESTONE DECORATO
SIDEBOARD 3 WOODEN DOORS, 1 DECORATED DEEP DRAWER

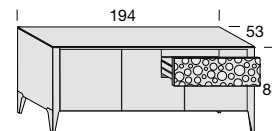

1 RIPIANO VETRO, APERTURA PUSH PULL
1 GLASS SHELF, PUSH PULL OPENING SYSTEM

MOG2031K

3.485

mc 1,01 – Kg 98

VETRINA MOON
MOON DISPLAY UNIT

VETRINA 2 ANTE LEGNO, 2 ANTE VETRO
DISPLAY UNIT WITH 2 WOODEN DOORS, 2 GLASS DOORS

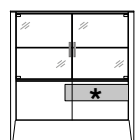
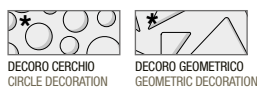

MAGG. PER DECORO BICOLORE
SURCH. FOR BICOLOR DECORATION **+ 5%**

FRASSINO / ASHWOOD

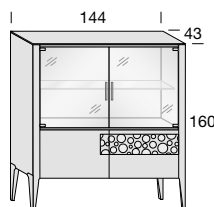

1 RIPIANO VETRO, 2 ANTE VETRO CON MANIGLIA, 2 ANTE LEGNO APERTURA PUSH PULL
1 GLASS SHELF, 2 GLASS DOORS WITH HANDLE, 2 WOODEN DOORS PUSH PULL OPENING SYSTEM

MOG3001K

3.411

mc 1,13 - kg 60

OPTIONAL

LED

+ 371

OPTIONAL
OPTIONAL

LED
BARRA LED
LED BAR



MOON GIORNO - DAY

TAVOLI, TAVOLINI E SEDIE

TABLES, COFFEE TABLES AND CHAIRS

TAVOLI MOON MOON TABLES

TAVOLO RETTANGOLARE ALLUNGABILE
RECTANGULA EXTENDING TABLE

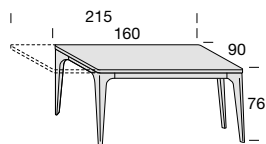

ALLUNGA DA 55
55 CM WIDE EXTENSION

MOG4011K

FRASSINO / ASHWOOD

2.749

mc 0,35 – Kg 47

TAVOLO RETTANGOLARE ALLUNGABILE
RECTANGULA EXTENDING TABLE

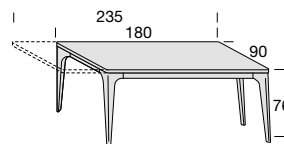

ALLUNGA DA 55
55 CM WIDE EXTENSION

MOG4001K

3.002

mc 0,35 – Kg 47

TAVOLINI MOON MOON SMALL TABLES



TAVOLINO QUADRATO
SQUARE SMALL TABLE

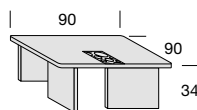

TOP LEGNO E DECORO
WOODEN TOP AND DECORATION

MOG4650K

FRASSINO / ASHWOOD

844

mc 0,26 – Kg 40

TAVOLINO RETTANGOLARE
RECTANGULAR SMALL TABLE

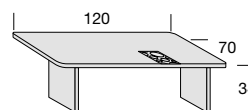

TOP LEGNO E DECORO
WOODEN TOP AND DECORATION

MOG4660K

820

mc 0,29 – Kg 34

TAVOLINI MOONLIGHT MOONLIGHT SMALL TABLES

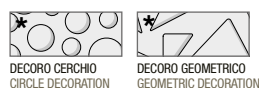

TAVOLINO QUADRATO
SQUARE SMALL TABLE

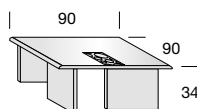

TOP VETRO E DECORO
GLASS TOP AND DECORATION

MOG4550K

FRASSINO / ASHWOOD

1.004

mc 0,26 – Kg 45

TAVOLINO RETTANGOLARE
RECTANGULAR SMALL TABLE

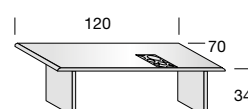

TOP VETRO E DECORO
GLASS TOP AND DECORATION

MOG4560K

967

mc 0,29 – Kg 39

SEDIE CHAIRS

SEDIA BARCELONA
BARCELONA CHAIR

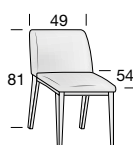

SEDILE E SCHIENALE IMBOTTITO
UPHOLSTERED BACK PANEL AND SEAT

DOG1021K

FAGGIO / BEECH

CAT. A	CAT. B	CAT. C
ECOPELLE/ECONABUK	LINO/VELLUTO	PELLE
ECOLEATHER/ECONABUK	LINEN/VELVET	LEATHER
525	590	743

mc 0,24 – Kg 10

SEDIA ELLE
ELLE CHAIR

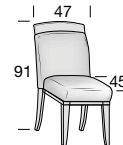

SEDILE E SCHIENALE IMBOTTITO
UPHOLSTERED BACK PANEL AND SEAT

CML1331K

CAT. A	CAT. B	CAT. C
ECOPELLE/ECONABUK	LINO/VELLUTO	PELLE
ECOLEATHER/ECONABUK	LINEN/VELVET	LEATHER
590	655	862

mc 0,30 – Kg 10

POLTRONE, DIVANI E POUF
ARMCHAIRS, SOFAS AND POUF

POLTRONE
ARMCHAIRS

POLTRONA DOMINO
DOMINO ARMCHAIR

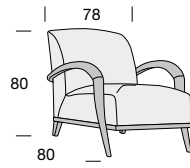

MON3001K		
CAT. A	CAT. B	CAT. C
ECOPELLE/ECONABUK ECOLEATHER/ECONABUK	LINO/VELLUTO LINEN/VELVET	PELLE LEATHER
3.578	3.652	4.300

NOCE CANALETTO / AMERICAN WALNUT

mc 0,64 – Kg 45

POLTRONA BUDDY
BUDDY ARMCHAIR

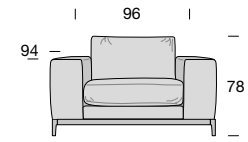

MOG9011K		
CAT. A	CAT. B	CAT. C
ECOPELLE/ECONABUK ECOLEATHER/ECONABUK	LINO/VELLUTO LINEN/VELVET	PELLE LEATHER
3.481	3.922	6.842

FAGGIO / BEECH

mc 0,80 – Kg 45

DIVANI BUDDY
BUDDY SOFAS

DIVANO BUDDY 2 POSTI
BUDDY SOFA 2 SEAT

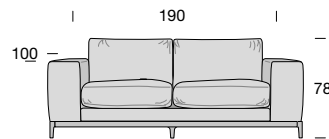

MOG9021K		
CAT. A	CAT. B	CAT. C
ECOPELLE/ECONABUK ECOLEATHER/ECONABUK	LINO/VELLUTO LINEN/VELVET	PELLE LEATHER
5.526	5.875	8.795

FAGGIO / BEECH

mc 1,80 – Kg 85

DIVANO BUDDY 3 POSTI
BUDDY SOFA 3 SEAT

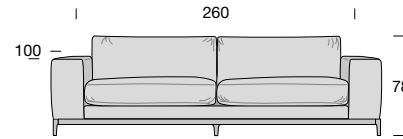

MOG9031K		
CAT. A	CAT. B	CAT. C
ECOPELLE/ECONABUK ECOLEATHER/ECONABUK	LINO/VELLUTO LINEN/VELVET	PELLE LEATHER
6.276	6.630	9.545

mc 2,45 – Kg 95

POUF DOMINO
DOMINO POUF

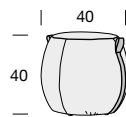

MANGIE IN CUIOIO
LEATHER HANDLE

CML3001K		
CAT. A	CAT. B	CAT. C
ECOPELLE/ECONABUK ECOLEATHER/ECONABUK	LINO/VELLUTO LINEN/VELVET	PELLE LEATHER
1.088	1.137	1.675

mc 0,08 – Kg 10

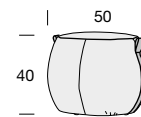

MANGIE IN CUIOIO
LEATHER HANDLE

CML3011K		
CAT. A	CAT. B	CAT. C
ECOPELLE/ECONABUK ECOLEATHER/ECONABUK	LINO/VELLUTO LINEN/VELVET	PELLE LEATHER
1.236	1.298	1.978

mc 0,12 – Kg 12

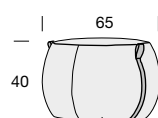

MANGIE IN CUIOIO
LEATHER HANDLE

CML3021K		
CAT. A	CAT. B	CAT. C
ECOPELLE/ECONABUK ECOLEATHER/ECONABUK	LINO/VELLUTO LINEN/VELVET	PELLE LEATHER
1.447	1.538	2.565

mc 0,21 – Kg 14

COMPOSIZIONE PAG. 82 - 83

COMPOSITION PAGE 82 - 83

1	MON5201K	LETTO HONEY DA 160 GIROLETTO LEGNO RIVESTIMENTO ECONABUK CAT. A HONEY BED WIDE 160, WOODEN BED SURROUND, ECONABUK CAT.A COVER	2.614
1	MON7001K	COMODINO MOON DX 2 CASSETTI MOON BEDSIDE TABLE RH WITH 2 DRAWERS	1.111
1	MON7002K	COMODINO MOON SX 2 CASSETTI MOON BEDSIDE TABLE LH WITH 2 DRAWERS	1.111
1	MON6001K	COMO' MOON 3 CASSETTI MOON 3-DRAWERS CHEST	2.542
1	MON8001K	ARMADIO MOON 2 ANTE SCORREVOLI CON DECORO MOON WARDROBE WITH 2 SLIDING DOORS AND DECORATION	5.067
TOTALE			12.445
TOTAL			



COMPOSIZIONE PAG. 88 - 89

COMPOSITION PAGE 88 - 89

1	MON5201K	LETTO HONEY DA 160 CON GIROLETTO LEGNO RIVESTIMENTO ECONABUK CAT. A HONEY BED WIDE 160 WOODEN BED SURROUND ECONABUK CAT. A COVER	2.614
1	MON7702K	COMODINO MOONLIGHT SX 2 CASSETTI MOONLIGHT BEDSIDE TABLE LH WITH 2 DRAWERS	982
1	MON7701K	COMODINO MOONLIGHT DX 2 CASSETTI MOONLIGHT BEDSIDE TABLE RH WITH 2 DRAWERS	982
1	MON6601K	COMO' MOONLIGHT 3 CASSETTI MOONLIGHT 3 - DRAWERS CHEST	2.057
1	MON9101K	SPECCHIERA SFERA SFERA MIRROR	634
1	MON8001K	ARMADIO MOON ANTE SCORREVOLI CON DECORO MOON WARDROBE WITH 2 SLIDING DOORS AND DECORATION	5.067
TOTALE			12.336
TOTAL			



COMPOSIZIONE PAG. 96 - 97

COMPOSITION PAGE 96 - 97

1	MON5201K	LETTO HONEY DA 160 GIROLETTO LEGNO RIVESTIMENTO ECONABUK CAT. A HONEY BED WITH HEADBORD WIDE 160 WOODEN BED SURROUND, ECONABUK CAT.A COVER	2.614
1	MON7001K	COMODINO MOON DX 2 CASSETTI MOON BEDSIDE TABLE RH WITH 2 DRAWERS	1.111
1	MON7002K	COMODINO MOON SX 2 CASSETTI MOON BEDSIDE TABLE LH WITH 2 DRAWERS	1.111
1	MON6001K	COMO' MOON 3 CASSETTI MOON 3-DRAWERS CHEST	2.542
TOTALE			7.378
TOTAL			



COMPOSIZIONE PAG.102 - 103

COMPOSITION PAGE 102 - 103

1	MON5301K	LETTO ALBA DA 160 CON GIROLETTO LEGNO RIVESTIMENTO ECONABUK CAT. A ALBA BED WIDE 160 WOODEN BED SURROUND ECONABUK CAT. A COVER	3.194
1	MON7702K	COMODINO MOONLIGHT SX 2 CASSETTI MOONLIGHT BEDSIDE TABLE LH WITH 2 DRAWERS	982
1	MON7701K	COMODINO MOONLIGHT DX 2 CASSETTI MOONLIGHT BEDSIDE TABLE RH WITH 2 DRAWERS	982
1	MON6601K	COMO' MOONLIGHT 3 CASSETTI MOONLIGHT 3 - DRAWERS CHEST	2.057
1	MON9001K	SPECCHIERA OVALE OVALE MIRROR	582
TOTALE			7.797
TOTAL			



COMPOSIZIONI A CATALOGO

CATALOGUE COMPOSITIONS

COMPOSIZIONE PAG.108 - 109

COMPOSITION PAGE 108 - 109

1	MON5101K	LETTO ALBA DA 160 CON GIROLETTO LEGNO E FASCIA IMBOTTITA RIVESTIMENTO ECONABUK CAT. A ALBA BED WIDE 160 WOODEN AND UPHOLSTERED BED SURROUND ECONABUK CAT. A COVER	3.597
1	MON7702K	COMODINO MOONLIGHT SX 2 CASSETTI MOONLIGHT BEDSIDE TABLE LH WITH 2 DRAWERS	982
1	MON7701K	COMODINO MOONLIGHT DX 2 CASSETTI MOONLIGHT BEDSIDE TABLE RH WITH 2 DRAWERS	982
1	MON6601K	COMO' MOONLIGHT 3 CASSETTI MOONLIGHT 3 - DRAWERS CHEST	2.057
1	MON8011K	ARMADIO VEGAS ANTE SCORREVOLI VEGAS WARDROBE WITH 2 SLIDING DOORS	5.642
TOTALE TOTAL			13.260



COMPOSIZIONE PAG.116 - 117

COMPOSITION PAGE 116 - 117

1	MON5301K	LETTO ALBA DA 160 CON GIROLETTO LEGNO RIVESTIMENTO ECONABUK CAT. A ALBA BED WIDE 160 WOODEN BED SURROUND ECONABUK CAT. A COVER	3.194
1	MON7002K	COMODINO MOON SX 2 CASSETTI, DECORO BICOLORE MOON BEDSIDE TABLE LH WITH 2 DRAWERS, BICOLOR	1.167
1	MON7001K	COMODINO MOON DX 2 CASSETTI, DECORO BICOLORE MOON BEDSIDE TABLE RH WITH 2 DRAWERS, BICOLOR	1.167
1	MON6001K	COMO' MOON 3 CASSETTI, DECORO BICOLORE MOON 3 - DRAWERS CHEST, BICOLOR	2.669
1	MON9001K	SPECCHIERA OVALE OVALE MIRROR	582
TOTALE TOTAL			8.779



COMPOSIZIONE PAG.124 - 125

COMPOSITION PAGE 124 - 125

1	MON5001K	LETTO MOON DA 160 CON GIROLETTO LEGNO MOON BED WIDE 160 WOODEN BED SURROUND	2.206
1	MON7702K	COMODINO MOONLIGHT SX 2 CASSETTI MOONLIGHT BEDSIDE TABLE LH WITH 2 DRAWERS	982
1	MON7701K	COMODINO MOONLIGHT DX 2 CASSETTI MOONLIGHT BEDSIDE TABLE RH WITH 2 DRAWERS	982
1	MON6601K	COMO' MOONLIGHT 3 CASSETTI MOONLIGHT 3 - DRAWERS CHEST	2.057
1	MON9001K	SPECCHIERA OVALE OVALE MIRROR	582
1	MON8021K	ARMADIO MOON ANTE SCORREVOLI MOON WARDROBE WITH 2 SLIDING DOORS	4.913
TOTALE TOTAL			11.722



COMPOSIZIONE PAG.132 - 133

COMPOSITION PAGE 132 - 133

1	MON5111K	LETTO NUVOVA DA 160 CON GIROLETTO LEGNO RIVESTIMENTO ECONABUK CAT. A MULTICOLOR NUVOVA BED WIDE 160 WOODEN BED SURROUND ECONABUK CAT. A COVER MULTICOLOR	3.296
1	MON7002K	COMODINO MOON SX 2 CASSETTI MOON BEDSIDE TABLE LH WITH 2 DRAWERS	1.111
1	MON7001K	COMODINO MOON DX 2 CASSETTI MOON BEDSIDE TABLE RH WITH 2 DRAWERS	1.111
1	MON6001K	COMO' MOON 3 CASSETTI MOON 3 - DRAWERS CHEST	2.542
TOTALE TOTAL			8.060



COMPOSIZIONI A CATALOGO CATALOGUE COMPOSITIONS

COMPOSIZIONE PAG.138 - 143

COMPOSITION PAGE 138 - 143

1	MON5111K	LETTO NUVOLA DA 160 GIROLETTO LEGNO RIVESTIMENTO ECONABUK CAT. A MULTICOLOR NUVOLA BED WIDE 160 WOODEN BED SURROUND WITH ECONABUK CAT.A COVER MULTICOLOR	3.296
1	MON7001K	COMODINO MOON DX 2 CASSETTI MOON BEDSIDE TABLE RH WITH 2 DRAWERS	1.111
1	MON7002K	COMODINO MOON SX 2 CASSETTI MOON BEDSIDE TABLE RH WITH 2 DRAWERS	1.111
1	MON6001K	COMO' MOON 3 CASSETTI MOON 3-DRAWERS CHEST	2.542
TOTALE TOTAL			8.060



COMPOSIZIONE 5

COMPOSITION 5

1	MON5001K	LETTO MOON DA 160 TESTIERA E GIROLETTO LEGNO MOON BED WIDW 160 WITH WOODEN HEADBOARD AND BED SURROUND	2.206
1	MON7001K	COMODINO MOON DX 2 CASSETTI MOON BEDSIDE TABLE RH WITH 2 DRAWERS	1.111
1	MON7002K	COMODINO MOON SX 2 CASSETTI MOON BEDSIDE TABLE RH WITH 2 DRAWERS	1.111
1	MON6001K	COMO' MOON 3 CASSETTI MOON 3-DRAWERS CHEST	2.542
TOTALE TOTAL			6.970



COMPOSIZIONE PAG. 66 - 67

COMPOSITION PAGE 66 - 67

1	MOG4001K	TAVOLO MOON BICOLOR 180x90 ALL.235 BICOLOR MOON TABLE 180x90 EXTEND. 235	3.002
4	CML1331K	SEDIA ELLE RIVESTIMENTO CAT. A ELLE CHAIR, COVER CAT. A	2.360
1	MOG2021K	CREDENZA MOON 3 ANTE MOON 3 DOORS SIDEBOARD	3.114
TOTALE TOTAL			8.476



COMPOSIZIONE PAG. 76 - 77

COMPOSITION PAGE 76 - 77

1	MOG4001K	TAVOLO MOON BICOLOR 180x90 ALL.235 BICOLOR MOON TABLE 180x90 EXTEND. 235	3.002
4	DOG1021K	SEDIA BARCELONA RIVESTIMENTO CAT. A BARCELONA CHAIR COVER CAT. A	2.100
1	MOG3001K	VETRINA MOON 2 ANTE VETRO E 2 ANTE LEGNO BICOLOR MOON DISPLAY UNIT 2 GLASS DOORS AND 2 BICOLOR WOODEN DOORS	3.581
TOTALE TOTAL			7.683



MOON SISTEMA COMPONIBILE

MOON MODULAR SYSTEM

CARATTERISTICHE TECNICHE E PARTICOLARITÀ DI UTILIZZO TECHNICAL CHARACTERISTICS AND PARTICULAR USE	28
ACCESSORI OPTIONAL OPTIONAL ACCESSORIES	34
ELEMENTI STRUTTURALI STRUCTURAL ELEMENTS	35
BASI A TERRA P. 40 FLOOR-STANDING BASE UNIT D. 40	36
BASI A TERRA P. 50 FLOOR-STANDING BASE UNIT D. 50	38
BASI SOSPESSE P. 40 SUSPENDED BASE UNIT D. 40	40
BASI SOSPESSE P. 50 SUSPENDED BASE UNIT D. 50	42
PENSILI ORIZZONTALI P. 40 HORIZONTAL WALL UNITS D. 40	44
PENSILI A GIORNO P. 30 OPEN WALL UNITS D. 30	46
PENSILI VERTICALI P. 40 VERTICAL WALL UNITS D. 40	48
COMPOSIZIONI A CATALOGO CATALOGUE COMPOSITIONS	50

MOON SISTEMA COMPONIBILE - MODULAR SYSTEM

CARATTERISTICHE TECNICHE E PARTICOLARITÀ DI UTILIZZO

TECHNICAL CHARACTERISTICS AND PARTICULAR USE

BASI E PENSILI

BASE UNITS AND WALL UNITS

FRONTALI

FRONTS

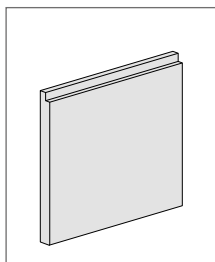

ANTA LEGNO LISCIA
PLAIN WOODEN DOOR

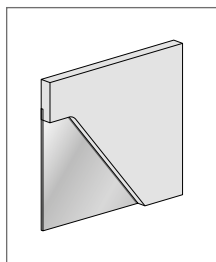

ANTA VETRO
GLASS DOOR

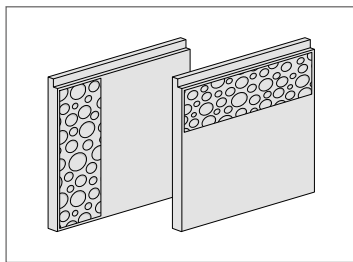

ANTA LEGNO DECORO CERCHIO
WOODEN DOOR CIRCLE DECORATION

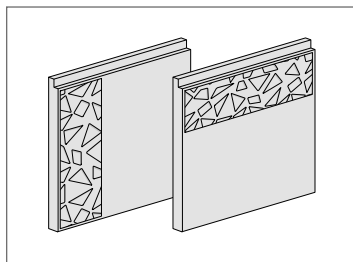

ANTA LEGNO DECORO GEOMETRICO
WOODEN DOOR GEOMETRIC DECORATION

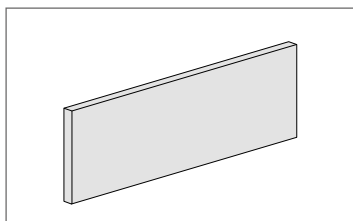

ANTA VASISTAS/RIBALTA LEGNO LISCIA
LIFT-UP/DROP DOWN PLAIN WOODEN DOOR

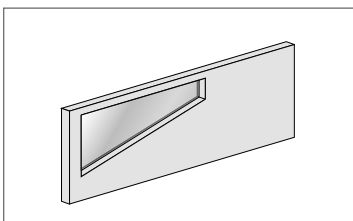

ANTA VASISTAS/RIBALTA VETRO LISCIA
LIFT-UP/DROP DOWN PLAIN GLASS DOOR

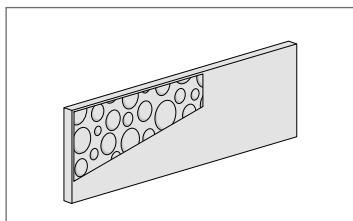

ANTA VASISTAS/RIBALTA LEGNO DECORO CERCHIO
LIFT-UP/DROP DOWN WOODEN DOOR CIRCLE DECORATION

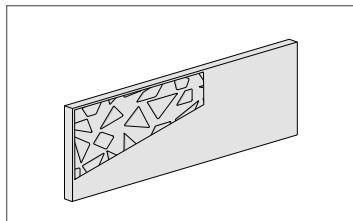

ANTA VASISTAS/RIBALTA LEGNO DECORO GEOMETRICO
LIFT-UP/DROP DOWN WOODEN DOOR GEOMETRIC DECORATION

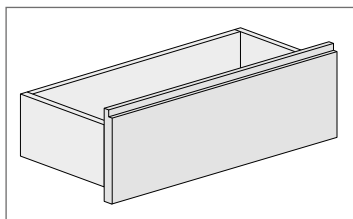

FRONTALE LEGNO LISCIO
PLAIN WOODEN FRONT

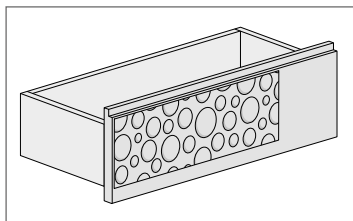

FRONTALE LEGNO DECORO CERCHIO
WOODEN FRONT CIRCLE DECORATION

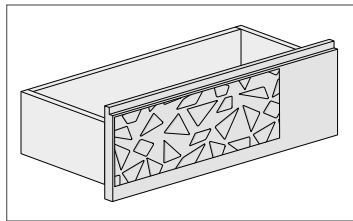

FRONTALE LEGNO DECORO GEOMETRICO
WOODEN FRONT GEOMETRIC DECORATION

STRUTTURA IN PANNELLO DI LISTELLARE IMPIALLACCIATO FRASSINO

TOP OBBLIGATORIO PANNELLO DI LEGNO MULTISTRATO IMPIALLACCIATO FRASSINO

FRONTALE LEGNO PANNELLO DI LISTELLARE IMPIALLACCIATO FRASSINO

FRONTALE VETRO TELAIO IN PANNELLO DI LISTELLARE IMPIALLACCIATO FRASSINO

ELEMENTI A GIORNO IN PANNELLO DI LISTELLARE IMPIALLACCIATO FRASSINO

CASSETTI E CESTONI STRUTTURA IN PANNELLO DI MULTISTRATO BETULLA, FONDO CASSETTO MULTISTRATO IMPIALLACCIATO FRASSINO

DECORO PANNELLO DI MULTISTRATO MASSELLO DI FRASSINO

SCHIENALE CASSETTI E CESTONI IN MULTISTRATO PIOPPO

ZOCCOLO IN PANNELLO DI LISTELLARE IMPIALLACCIATO FRASSINO

RIPIANI INTERNI VETRO

STRUCTURE BLOCKBOARD PANEL COVERED IN ASWOOD

COMPUSLORY TOP MULTILAYER WOOD PANEL COVERED IN ASHWOOD

WOODEN FRONT MULTILAYER PANEL COVERED IN ASHWOOD

GLASS FRONT FRAME IN MULTILAYER PANEL COVERED IN ASHWOOD

OPEN ELEMENTS BLOCKBOARD PANEL COVERED IN ASHWOOD

DRAWERS AND BASKETS STRUCTURE IN MULTILAYER BIRCH PANEL, DRAWER BOTTOM IN MULTILAYER ASHWOOD

DECORATION SOLID ASWOOD MULTILAYER PANEL

BACK PANEL OF DRAWERS MULTILAYER PANEL IN POPLAR

PLINTH BLOCKBOARD PANEL COVERED IN ASHWOOD

INTERNAL SHELVES GLASS

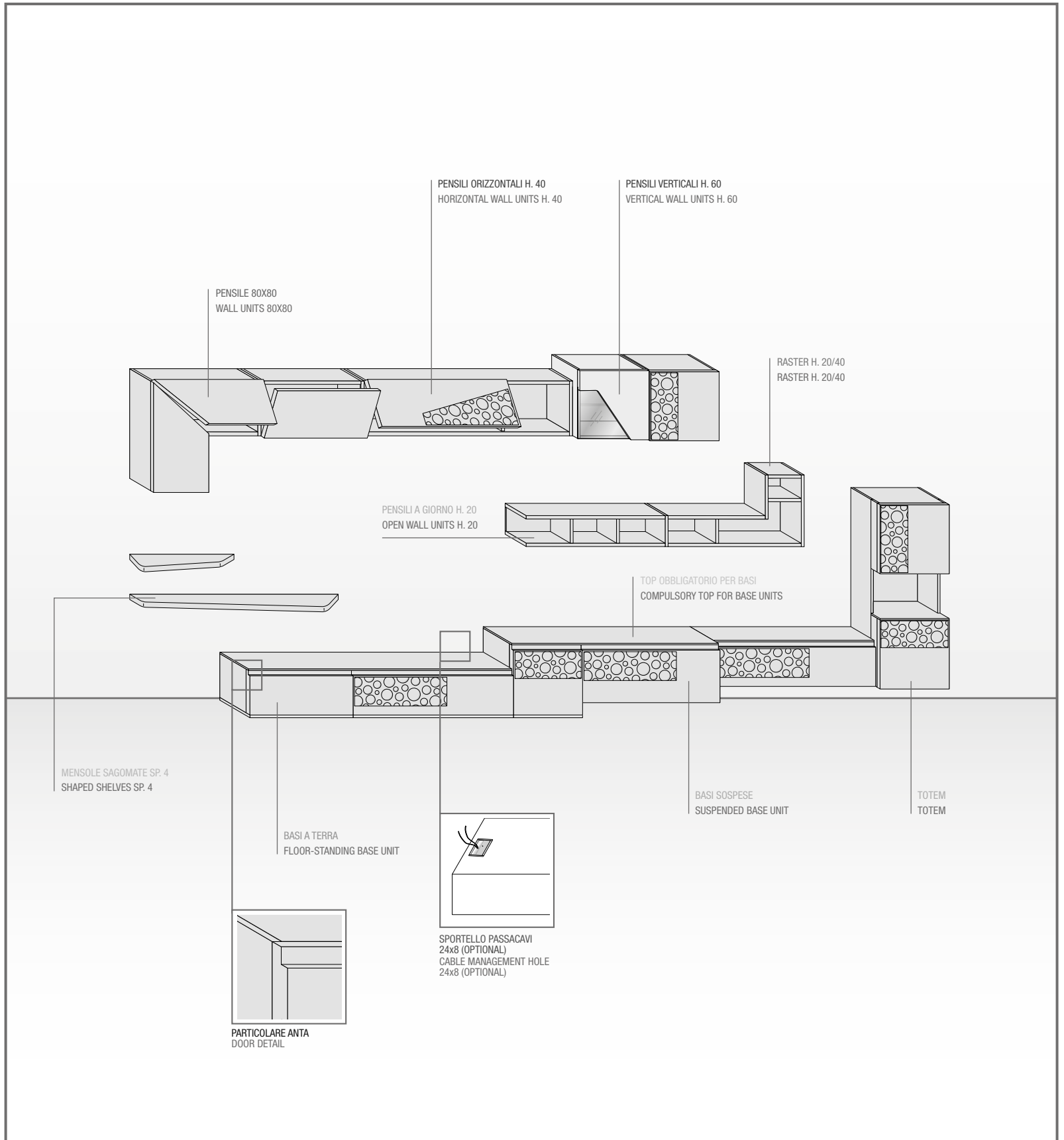

MOON SISTEMA COMPONIBILE - MODULAR SYSTEM

MODULARITÀ

MODULARITY

BASI A TERRA H. 31.5 P. 40
FLOOR-STANDING BASE UNIT H. 31.5 D. 40

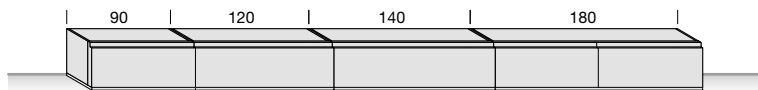

BASI A TERRA H. 41.5 P. 40
FLOOR-STANDING BASE UNIT H. 41.5 D. 40



BASI A TERRA H. 61.5 P. 40
FLOOR-STANDING BASE UNIT H. 61.5 D. 40



BASI A TERRA H. 31.5 P. 50
FLOOR-STANDING BASE UNIT H. 31.5 D. 50

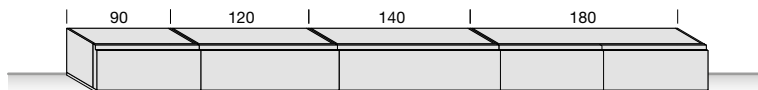

BASI A TERRA H. 41.5 P. 50
FLOOR-STANDING BASE UNIT H. 41.5 D. 50



BASI A TERRA H. 61.5 P. 50
FLOOR-STANDING BASE UNIT H. 61.5 D. 50



BASI SOSPESE H. 30 P. 40
SUSPENDED BASE UNIT H. 30 D. 40

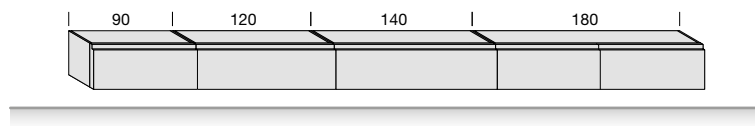

BASI SOSPESE H. 40 P. 40
SUSPENDED BASE UNIT H. 40 D. 40

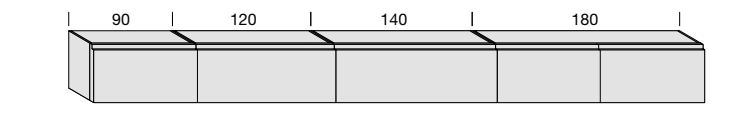

BASI SOSPESE H. 60 P. 40
SUSPENDED BASE UNIT H. 60 D. 40



BASI SOSPESE H. 30 P. 50
SUSPENDED BASE UNIT H. 30 D. 50

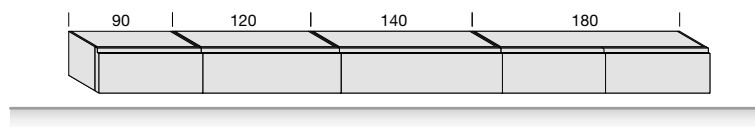

BASI SOSPESE H. 40 P. 50
SUSPENDED BASE UNIT H. 40 D. 50

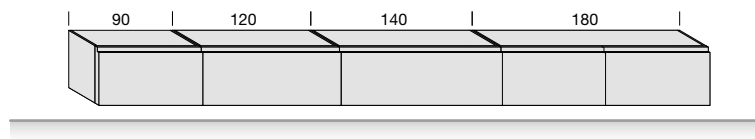

BASI SOSPESE H. 60 P. 50
SUSPENDED BASE UNIT H. 60 D. 50



MODULARITÀ MODULARITY

PENSILI ORIZZONTALI H. 40 P. 40 HORIZONTAL WALL UNITS H. 40 D. 40

CON ANTA VASISTAS
WITH LIFT-UP DOOR

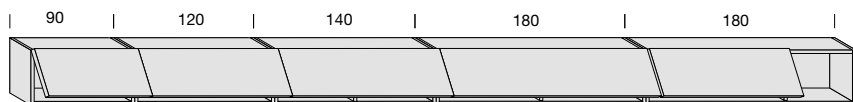

CON ANTA A RIBALTA
WITH DROP-DOWN DOOR

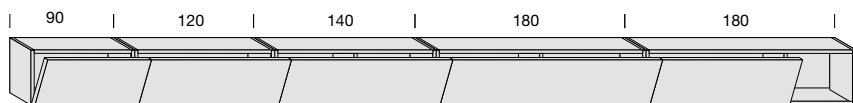

PENSILI A GIORNO H. 20 P. 30 OPEN WALL UNITS H. 20 D. 30

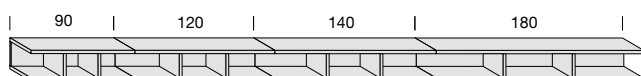

RASTER H. 60 P. 30 RASTER H. 60 D. 30

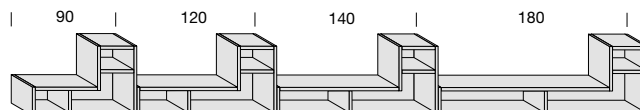

PENSILI VERTICALI H. 60 P. 40 VERTICAL WALL UNITS H. 60 D. 40

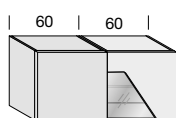

PENSILI VERTICALI 80X80 P. 40 VERTICAL WALL UNITS 80X80 D. 40

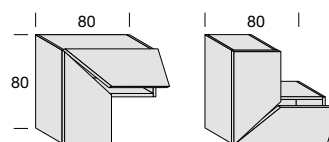

TOTEM H. 160 TOTEM H. 160

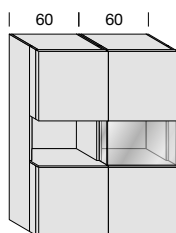

MOON SISTEMA COMPONIBILE - MODULAR SYSTEM

CARATTERISTICHE TECNICHE E PARTICOLARITÀ DI UTILIZZO

TECHNICAL CHARACTERISTICS AND PARTICULAR USE

INGOMBRI CASSETTI E CESTONI

DRAWERS AND BASKETS SIZE

FRONTALE CASSETTO DRAWER FRONT

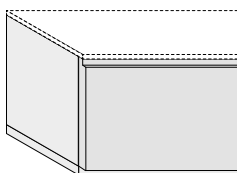

PROFONDITÀ CASSETTI DRAWERS DEPTH

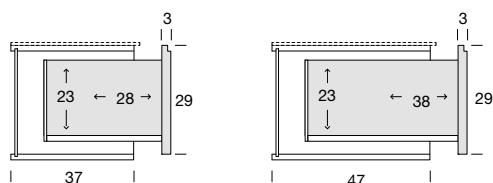

LARGHEZZE CASSETTI E CESTONI DRAWERS AND BASKETS WIDTH

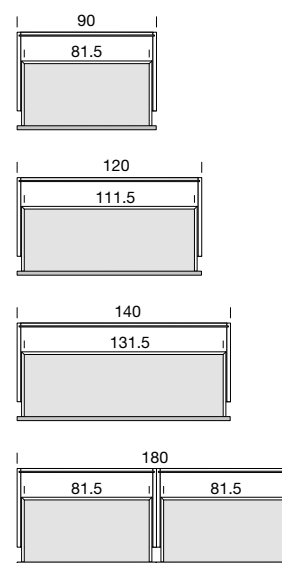

FRONTALE CESTONE BASKET FRONT

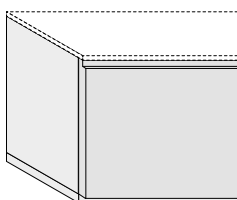

PROFONDITÀ CESTONI BASKETS DEPTH

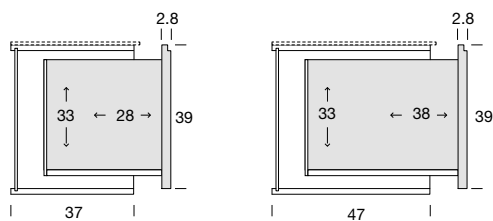

TOP OBBLIGATORIO PER BASI COMPULSORY TOP FOR BASE UNITS

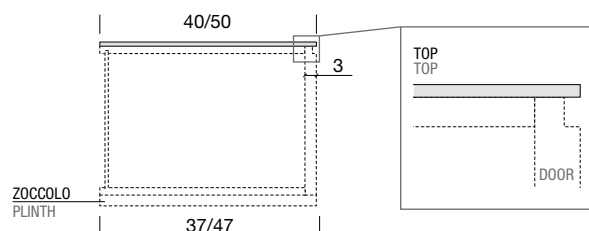
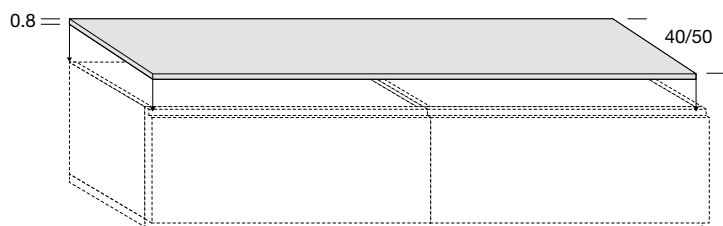

ALTEZZE MASSIME DI POSIZIONAMENTO ANTE VASISTAS/RIBALTA MAXIMUM POSITION HEIGHTS FOR LIFT-UP/DROP-DOWN DOORS

È POSSIBILE SOVRAPPORRE ANTE VASISTAS SI VASISTAS E RIBALTA SU RIBALTA
IT IS POSSIBLE TO STACK LIFT-UP DOORS ON LIFT-UP DOORS AND DROP-DOWN DOORS ON DROP-DOWN DOORS

ANTA VASISTAS LIFT-UP DOOR

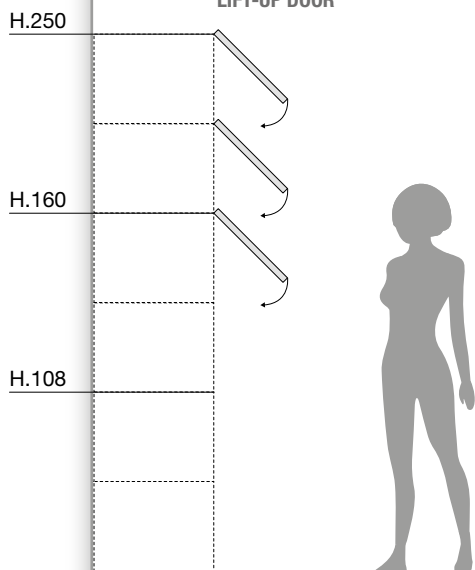

ANTA RIBALTA DROP-DOWN DOOR

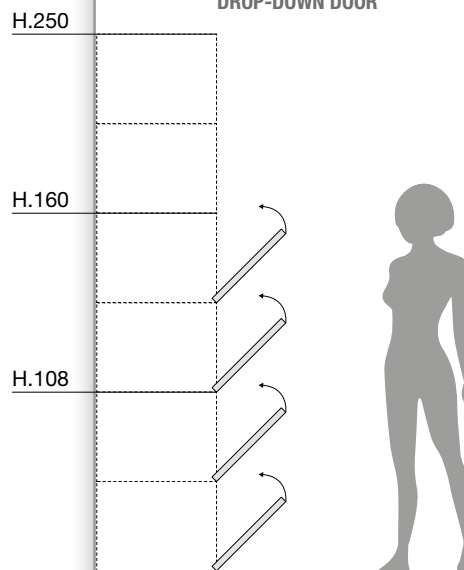

CARATTERISTICHE TECNICHE E PARTICOLARITÀ DI UTILIZZO

TECHNICAL CHARACTERISTICS AND PARTICULAR USE

PENSILE ORIZZONTALE CON ANTE E VANO A GIORNO HORIZONTAL WALL UNITS WITH DOORS AND OPEN COMPARTMENT

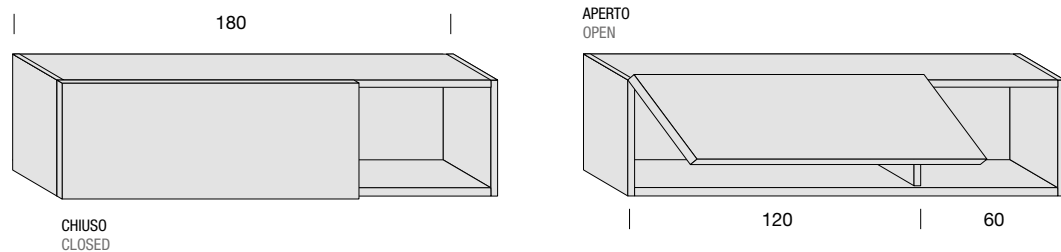

PENSILI CON ANTA VETRO P. 40 WALL UNITS WITH GLASS DOOR D. 40

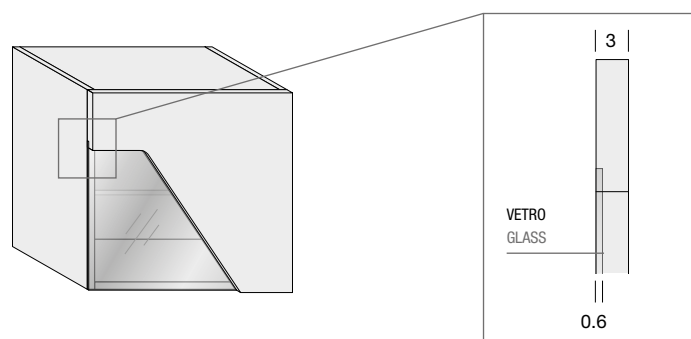

ANTA IN PANNELLO DI LISTELLARE
IMPIALLACIATO FRASSINO SP. 3
VETRO TEMPERATO SP. 0.6

BLOCKBOARD PANEL VENEERED IN ASHWOOD
TH. 33
TEMPERED GLASS TH. 0.6

TOTEM VERTICALE CON VANO A GIORNO E RIPIANI INTERNI VETRO VERTICAL TOTEM WITH OPEN COMPARTMENT AND GLASS INTERNAL SHELVES

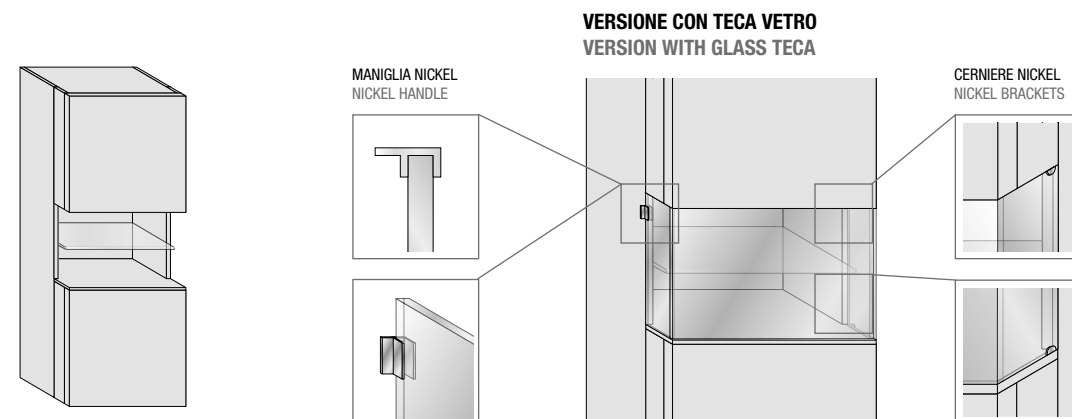

ATTACCAGLIA PER PENSILI (DI SERIE) E BASI SOSPENSE BRACKETS FOR WALL UNITS (AS STANDARD) AND SUSPENDED BASE UNITS

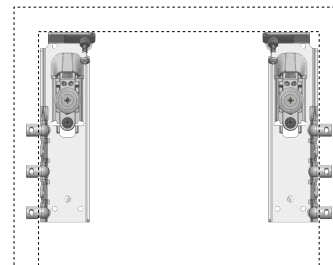

L'ATTACCAGLIA PREVEDE IL MONTAGGIO IN APPOGGIO
AL CAPPELLO NEL RETRO DEL MOBILE, CONSENTENDO IL
PERFETTO APPOGGIO A MURO.
DISPONIBILE DX O SX.
PORTATA KG. 70 PER ATTACCAGLIA.

HANGERS ARE TO BE FITTED TO THE FINISHING TOP ON THE
BACK OF THE UNIT SO THAT IT CAN ADHERE PERFECTLY TO
THE WALL.
AVAILABLE R/H OR L/H.
CAPACITY 70KG PER HANGER.

LIMITI DI UTILIZZO PER PENSILI VASISTAS E RIBALTA USE FOR WALL UNITS WITH LIFT-UP DOORS AND DROP-DOWN DOORS LIFT-UP DOOR DROP-DOWN DOOR

È POSSIBILE SOVRAPPORRE DUE PENSILI VASISTAS O
DUE PENSILI RIBALTA SOLO CAMBIANDO CERNIERE

IT IS POSSIBLE TO STACK TWO WALL UNITS WITH LIFT-
UP DOORS OR TWO WALL UNITS WITH DROPDOWN
DOORS ONLY WITH CHANGING THE HINGES

MENSOLA SAGOMATA SP.4 SHAPED SHELF TH.4

VISTA IN PIANTA
PLAN VIEW

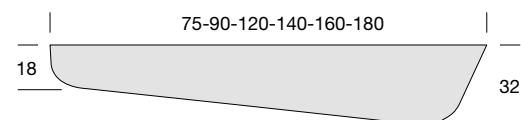

POSIZIONAMENTO MENSOLONE SP. 6 LARGE SHELF POSITIONING

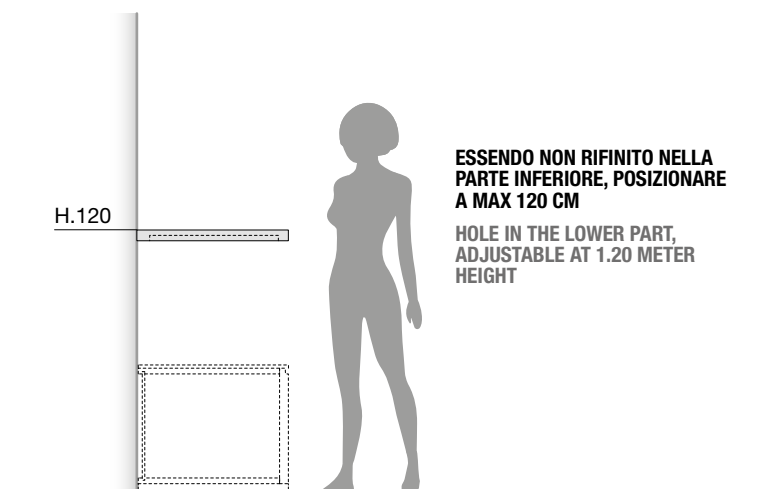

ESSENDO NON RIFINITO NELLA
PARTE INFERIORE, POSIZIONARE
A MAX 120 CM

HOLE IN THE LOWER PART,
ADJUSTABLE AT 1.20 METER
HEIGHT

MOON SISTEMA COMPONIBILE - MODULAR SYSTEM

ACCESSORI OPTIONAL
OPTIONAL ACCESSORIES

**BARRA LED A BASSO CONSUMO
ACCENSIONE TOUCH
IN ALLUMINIO L. 37.2
COLLEGAMENTO
A CARICO DEL CLIENTE**

**LOW CONSUMPTION LED BAR
TOUCH SWITCH
IN ALUMINIUM W. 37.2
CONNECTIONS
TO BE MADE BY THE CUSTOMER.**



codice
code

ZZZFE22001

163

**ALIMENTATORE
POWER SUPPLY**

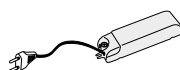

codice
code

ZZZFE22002

67

**TELECOMANDO
REMOTE CONTROL**



codice
code

ZZZFE22004

158

**KIT SPORTELLO PASSACAVI
+ BORCHIA
KIT FOR CABLE MANAGEMENT HOLE
+ COVER**

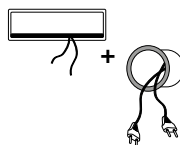

codice
code

ZZZFE22005

133

**MULTIPRESA A SCOMPARSA CON
SPORTELLINO APRI/CHIUDI IN
METALLO**

**CONCEALED MULTIPLE SOCKET
WITH METAL OPEN/CLOSE FLAP**

VERSIONE TV:
1 PRESA SCHUKO
2 PRESI USB RICARICA
1 PRESA SAT.
TV VERSION:
1 SCHUKO SOCKET
2 SOCKETS USB CHARGE
1 SAT. SOCKET



codice
code

ZZZFE22030

595

VERSIONE PC/MAC:
1 PRESA SCHUKO
2 PORTE USB DATI
1 PORTA HDMI
PC/MAC VERSION:
1 SCHUKO SOCKET
2 USB PORT
1 HDMI PORT



codice
code

ZZZFE22031

595

ELEMENTI STRUTTURALI STRUCTURAL ELEMENTS

MENSOLE SAGOMATE P. 18/32 – SP. 4 SHAPED SHELVES D. 18/32 – TH. 4

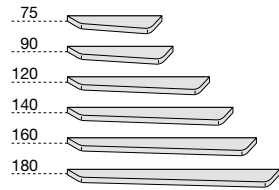

larghezza width	codice dx/sx code rh/lh	FRASSINO ASHWOOD	
75	MOC3501K	217	mc 0,02 – Kg 2
90	MOC3511K	271	mc 0,03 – Kg 3
120	MOC3521K	331	mc 0,03 – Kg 6
140	MOC3531K	386	mc 0,04 – Kg 9
160	MOC3541K	415	mc 0,05 – Kg 9
180	MOC3551K	433	mc 0,05 – Kg 9

MENSOLONI SP. 6 P 50 DA APPOGGIO POSIZIONABILI MAX H. 1,2 METRI. PER AUTOPORTANTE AGGIUNGERE STAFFE DA MURO (+ 50,00 €)

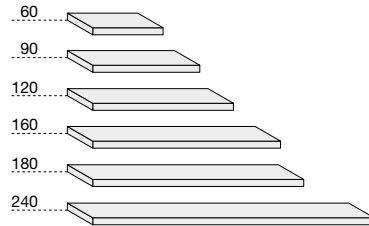

LARGE SHELVES TH. 6 D 50 SELF-STANDING 1,2 METER MAX ADJUSTABLE. FOR SELF-SUPPORTING ADD WALL BRACKETS (+ 50,00 €)

larghezza width	codice code	FRASSINO ASHWOOD	
60	DCC3001K	223	mc 0,02 – Kg 2
90	DCC3011K	318	mc 0,03 – Kg 4
120	DCC3021K	415	mc 0,05 – Kg 7
160	DCC3061K	511	mc 0,06 – Kg 10
180	DCC3031K	554	mc 0,07 – Kg 10
240	DCC3041K	758	mc 0,09 – Kg 14

TOP SP. 0.8 P. 40 OBBLIGATORIO PER BASI TOP TH. 0.8 D. 40 COMPULSORY FOR BASE UNITS

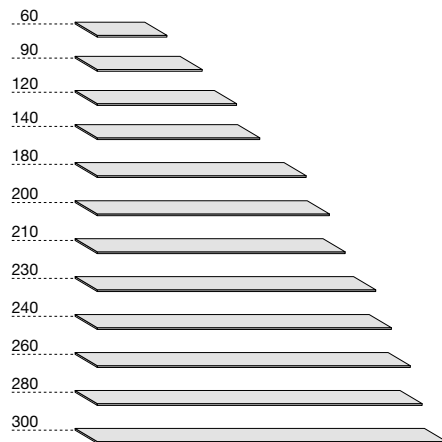

IL PREZZO DEL TOP DEVE ESSERE SOMMATO A QUELLO DELLE BASI
ADD THE PRICE OF THE TOP TO THE PRICE OF THE BASE UNITS.

larghezza width	codice code	FRASSINO ASHWOOD	
60	MOC5051K	145	mc 0,05 – Kg 1
90	MOC5061K	168	mc 0,05 – Kg 1
120	MOC5001K	198	mc 0,05 – Kg 2
140	MOC5011K	217	mc 0,05 – Kg 2
180	MOC5021K	265	mc 0,06 – Kg 3
200	MOC5031K	361	mc 0,06 – Kg 4
210	MOC5071K	366	mc 0,06 – Kg 4
230	MOC5081K	386	mc 0,06 – Kg 4
240	MOC5091K	397	mc 0,06 – Kg 4
260	MOC5101K	494	mc 0,06 – Kg 4
280	MOC5111K	500	mc 0,06 – Kg 5
300	MOC5041K	524	mc 0,06 – Kg 5

TOP SP. 0.8 P. 50 OBBLIGATORIO PER BASI TOP TH. 0.8 D. 50 COMPULSORY FOR BASE UNITS

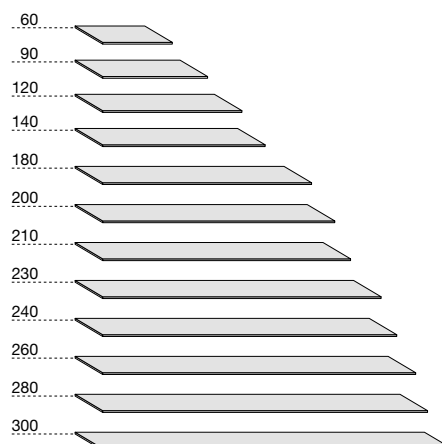

IL PREZZO DEL TOP DEVE ESSERE SOMMATO A QUELLO DELLE BASI
ADD THE PRICE OF THE TOP TO THE PRICE OF THE BASE UNITS.

larghezza width	codice code	FRASSINO ASHWOOD	
60	MOC5351K	150	mc 0,05 – Kg 1
90	MOC5361K	175	mc 0,05 – Kg 1
120	MOC5301K	211	mc 0,05 – Kg 3
140	MOC5311K	229	mc 0,05 – Kg 3
180	MOC5321K	278	mc 0,06 – Kg 4
200	MOC5331K	374	mc 0,06 – Kg 5
210	MOC5371K	386	mc 0,06 – Kg 5
230	MOC5381K	397	mc 0,06 – Kg 5
240	MOC5391K	422	mc 0,06 – Kg 5
260	MOC5401K	511	mc 0,06 – Kg 6
280	MOC5411K	524	mc 0,06 – Kg 6
300	MOC5341K	567	mc 0,06 – Kg 7

MOON SISTEMA COMPONIBILE - MODULAR SYSTEM

BASI A TERRA P. 40

FLOOR-STANDING BASE UNIT D. 40

BASI H. 31.5 BASE UNIT H. 31.5

1 CASSETTO
1 DRAWER

1 CASSETTO DECORATO
1 DECORATED DRAWER

1 CASSETTO
1 DRAWER

1 CASSETTO DECORATO
1 DECORATED DRAWER

AGGIUNGERE TOP
OBBLIGATORIO NON
COMPRESO NEL PREZZO
DELLA BASE VEDI PAG. 35
ADD COMPULSORY TOP NOT
INCLUDED IN THE PRICE OF
BASE UNIT SEE PAGE 35

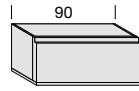

*

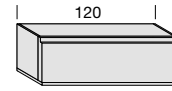
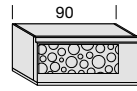

*

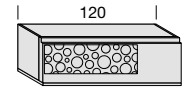

MOC1001K

MOC1011K

MOC1021K

MOC1031K

FRASSINO / ASHWOOD

920

1.112

1.011

1.191

mc 0,13 – Kg 20

mc 0,13 – Kg 20

mc 0,18 – Kg 25

mc 0,18 – Kg 25

BASI H. 41.5 BASE UNIT H. 41.5

1 CESTONE
1 BASKET

1 CESTONE DECORATO
1 DECORATED BASKET

1 CESTONE
1 BASKET

1 CESTONE DECORATO
1 DECORATED BASKET

AGGIUNGERE TOP
OBBLIGATORIO NON
COMPRESO NEL PREZZO
DELLA BASE VEDI PAG. 35
ADD COMPULSORY TOP NOT
INCLUDED IN THE PRICE OF
BASE UNIT SEE PAGE 35

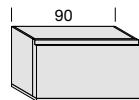

*

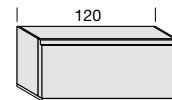
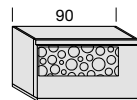

*

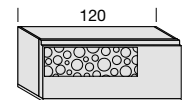

MOC1081K

MOC1091K

MOC1101K

MOC1111K

FRASSINO / ASHWOOD

1.034

1.221

1.112

1.298

mc 0,18 – Kg 25

mc 0,18 – Kg 25

mc 0,24 – Kg 33

mc 0,24 – Kg 33

BASI H. 61.5 BASE UNIT H. 61.5

1 ANTA, 1 RIPIANO VETRO
1 DOOR, 1 GLASS SHELF

1 ANTA CON DECORO, 1 RIPIANO VETRO
1 DECORATION DOOR, 1 GLASS SHELF

AGGIUNGERE TOP
OBBLIGATORIO NON
COMPRESO NEL PREZZO
DELLA BASE VEDI PAG. 35
ADD COMPULSORY TOP NOT
INCLUDED IN THE PRICE OF
BASE UNIT SEE PAGE 35

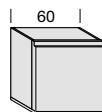

*

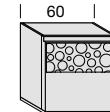

DX / RH
SX / LH

MOC1161K
MOC1261K

MOC1171K
MOC1271K

FRASSINO / ASHWOOD

938

1.064

mc 0,18 – Kg 23

mc 0,18 – Kg 23

1 CASSETTO
1 DRAWER

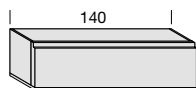

MOC1041K

1.100

mc 0,21 – Kg 27

1 CASSETTO DECORATO
1 DECORATED DRAWER

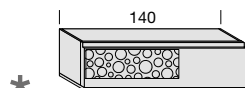

MOC1051K

1.288

mc 0,21 – Kg 27

2 CASSETTI
2 DRAWERS



MOC1061K

1.624

mc 0,27 – Kg 53

1 CASSETTO DECORATO, 1 CASSETTO
1 DECORATED DRAWER, 1 DRAWER

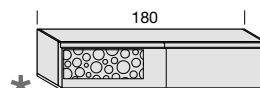

MOC1071K

1.785

mc 0,27 – Kg 53

1 CESTONE
1 BASKET



MOC1121K

1.203

mc 0,28 – Kg 39

1 CESTONE DECORATO
1 DECORATED BASKET

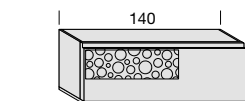

MOC1131K

1.389

mc 0,28 – Kg 39

2 CESTONI
2 BASKETS

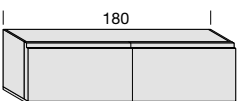

MOC1141K

1.702

mc 0,36 – Kg 52

1 CESTONE DECORATO, 1 CESTONE
1 DECORATED BASKET, 1 BASKET

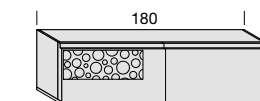

MOC1151K

1.870

mc 0,36 – Kg 52

1 ANTA CON DECORO, 1 RIPIANO VETRO
1 DECORATION DOOR, 1 GLASS SHELF

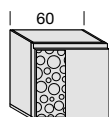

*

MOC1181K
MOC1281K

1.064

mc 0,18 – Kg 23

OPTIONAL
OPTIONAL

KIT SPORTELLINO PASSACAVI
+ BORCHIA
KIT FOR CABLE MANAGEMENT HOLE
+ COVER

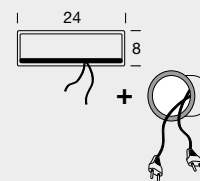

ZZZFE22005

133

*
SPECIFICARE SEMPRE IL TIPO DI
DECORO IL PREZZO È LO STESSO
(RAPPRESENTATO DECORO
CERCHIO)

ALWAYS INDICATE THE TYPE OF
DECORATION, IT IS THE SAME
PRICE (CIRCLE DECORATION
REPRESENTED)



CIRCLE DECORATION



GEOMETRIC DECORATION

POSSIBILITÀ DI TOP CON COLORE
DIVERSO DALLA STRUTTURA, SENZA
MAGGIORAZIONE DI PREZZO

POSSIBILITY OF TOP WITH
DIFFERENT COLOR FROM THE
CARCASE, WITHOUT SURCHARGE

MOON SISTEMA COMPONIBILE - MODULAR SYSTEM

BASI A TERRA P. 50

FLOOR-STANDING BASE UNIT D. 50

BASI H. 31.5
BASE UNIT H. 31.5

1 CASSETTO
1 DRAWER

1 CASSETTO DECORATO
1 DECORATED DRAWER

1 CASSETTO
1 DRAWER

1 CASSETTO DECORATO
1 DECORATED DRAWER

AGGIUNGERE TOP
OBBLIGATORIO NON
COMPRESO NEL PREZZO
DELLA BASE VEDI PAG. 35
ADD COMPULSORY TOP NOT
INCLUDED IN THE PRICE OF
BASE UNIT SEE PAGE 35

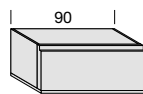

*

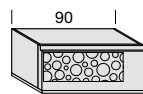

*

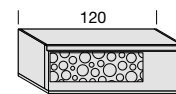

MOC1501K

MOC1511K

MOC1521K

MOC1531K

FRASSINO / ASHWOOD

938

999

1.041

1.227

mc 0,18 – Kg 27

mc 0,18 – Kg 27

mc 0,23 – Kg 30

mc 0,23 – Kg 30

BASI H. 41.5
BASE UNIT H. 41.5

1 CESTONE
1 BASKET

1 CESTONE DECORATO
1 DECORATED BASKET

1 CESTONE
1 BASKET

1 CESTONE DECORATO
1 DECORATED BASKET

AGGIUNGERE TOP
OBBLIGATORIO NON
COMPRESO NEL PREZZO
DELLA BASE VEDI PAG. 35
ADD COMPULSORY TOP NOT
INCLUDED IN THE PRICE OF
BASE UNIT SEE PAGE 35

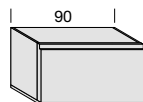

*

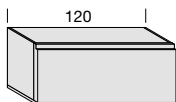
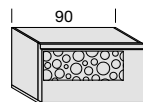

*

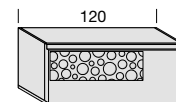

MOC1581K

MOC1591K

MOC1601K

MOC1611K

FRASSINO / ASHWOOD

1.047

1.245

1.143

1.336

mc 0,23 – Kg 32

mc 0,23 – Kg 32

mc 0,30 – Kg 41

mc 0,30 – Kg 41

BASI H. 61.5
BASE UNIT H. 61.5

1 ANTA, 1 RIPIANO VETRO
1 DOOR, 1 GLASS SHELF

1 ANTA CON DECORO, 1 RIPIANO VETRO
1 DECORATION DOOR, 1 GLASS SHELF

AGGIUNGERE TOP
OBBLIGATORIO NON
COMPRESO NEL PREZZO
DELLA BASE VEDI PAG. 35
ADD COMPULSORY TOP NOT
INCLUDED IN THE PRICE OF
BASE UNIT SEE PAGE 35

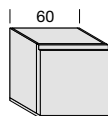

*

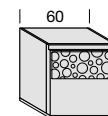

DX / RH
SX / LH

MOC1661K
MOC1761K

MOC1671K
MOC1771K

FRASSINO / ASHWOOD

962

1.089

mc 0,22 – Kg 29

mc 0,22 – Kg 29

1 CASSETTO
1 DRAWER

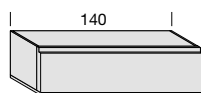

MOC1541K

1.136

mc 0,27 - Kg 35

1 CASSETTO DECORATO
1 DECORATED DRAWER

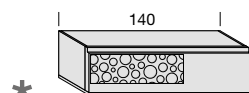

MOC1551K

1.328

mc 0,27 - Kg 35

2 CASSETTI
2 DRAWERS

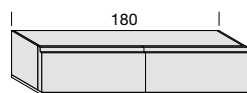

MOC1561K

1.696

mc 0,35 - Kg 53

1 CASSETTO DECORATO, 1 CASSETTO
1 DECORATED DRAWER, 1 DRAWER

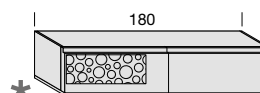

MOC1571K

1.864

mc 0,35 - Kg 53

1 CESTONE
1 BASKET

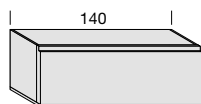

MOC1621K

1.250

mc 0,35 - Kg 49

1 CESTONE DECORATO
1 DECORATED BASKET

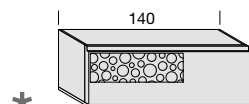

MOC1631K

1.438

mc 0,35 - Kg 49

2 CESTONI
2 BASKETS

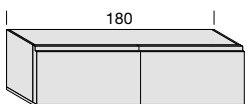

MOC1641K

1.768

mc 0,44 - Kg 66

1 CESTONE DECORATO, 1 CESTONE
1 DECORATED BASKET, 1 BASKET

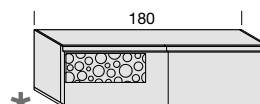

MOC1651K

1.930

mc 0,44 - Kg 66

1 ANTA CON DECORO, 1 RIPIANO VETRO
1 DECORATION DOOR, 1 GLASS SHELF

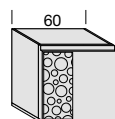

*

MOC1681K
MOC1781K

1.089

mc 0,22 - Kg 29

OPTIONAL
OPTIONAL

KIT SPORTELLINO PASSACAVI
+ BORCHIA
KIT FOR CABLE MANAGEMENT HOLE
+ COVER

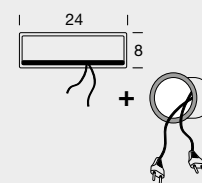

ZZZFE22005

133

*
SPECIFICARE SEMPRE IL TIPO DI
DECORO IL PREZZO È LO STESSO
(RAPPRESENTATO DECORO
CERCHIO)

ALWAYS INDICATE THE TYPE OF
DECORATION, IT IS THE SAME
PRICE (CIRCLE DECORATION
REPRESENTED)



CIRCLE DECORATION

GEOMETRIC DECORATION

POSSIBILITÀ DI TOP CON COLORE
DIVERSO DALLA STRUTTURA, SENZA
MAGGIORAZIONE DI PREZZO

POSSIBILITY OF TOP WITH
DIFFERENT COLOR FROM THE
CARCASE, WITHOUT SURCHARGE

MOON SISTEMA COMPONIBILE - MODULAR SYSTEM

BASI SOSPENSE P. 40

SUSPENDED BASE UNIT D. 40

BASI H. 30
BASE UNIT H. 30

1 CASSETTO
1 DRAWER

1 CASSETTO DECORATO
1 DECORATED DRAWER

1 CASSETTO
1 DRAWER

1 CASSETTO DECORATO
1 DECORATED DRAWER

AGGIUNGERE TOP
OBBLIGATORIO NON
COMPRESO NEL PREZZO
DELLA BASE VEDI PAG. 35

ADD COMPULSORY TOP NOT
INCLUDED IN THE PRICE OF
BASE UNIT SEE PAGE 35

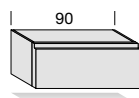

MOC1002K

*

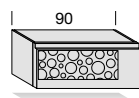

MOC1012K

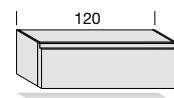

MOC1022K

*

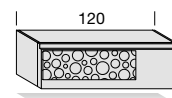

MOC1032K

FRASSINO / ASHWOOD

920

mc 0,13 – Kg 20

1.112

mc 0,13 – Kg 20

1.011

mc 0,18 – Kg 25

1.191

mc 0,18 – Kg 25

BASI H. 40
BASE UNIT H. 40

1 CESTONE
1 BASKET

1 CESTONE DECORATO
1 DECORATED BASKET

1 CESTONE
1 BASKET

1 CESTONE DECORATO
1 DECORATED BASKET

AGGIUNGERE TOP
OBBLIGATORIO NON
COMPRESO NEL PREZZO
DELLA BASE VEDI PAG. 35

ADD COMPULSORY TOP NOT
INCLUDED IN THE PRICE OF
BASE UNIT SEE PAGE 35

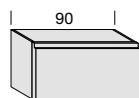

MOC1082K

*

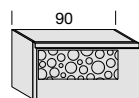

MOC1092K

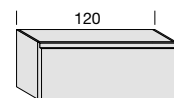

MOC1102K

*

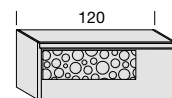

MOC1112K

FRASSINO / ASHWOOD

1.034

mc 0,18 – Kg 25

1.221

mc 0,18 – Kg 25

1.112

mc 0,24 – Kg 33

1.298

mc 0,24 – Kg 33

BASI H. 60
BASE UNIT H. 60

1 ANTA, 1 RIPIANO VETRO
1 DOOR, 1 GLASS SHELF

1 ANTA CON DECORO, 1 RIPIANO VETRO
1 DECORATION DOOR, 1 GLASS SHELF

AGGIUNGERE TOP
OBBLIGATORIO NON
COMPRESO NEL PREZZO
DELLA BASE VEDI PAG. 35

ADD COMPULSORY TOP NOT
INCLUDED IN THE PRICE OF
BASE UNIT SEE PAGE 35

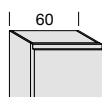

DX / RH
SX / LH

MOC1162K
MOC1262K

*

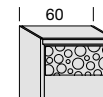

MOC1172K
MOC1272K

FRASSINO / ASHWOOD

938

mc 0,18 – Kg 23

1.064

mc 0,18 – Kg 23

1 CASSETTO
1 DRAWER

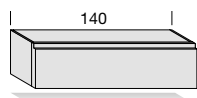

MOC1042K

1.100

mc 0,21 – Kg 27

1 CASSETTO DECORATO
1 DECORATED DRAWER

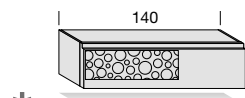

*

MOC1052K

1.288

mc 0,21 – Kg 27

2 CASSETTI
2 DRAWERS

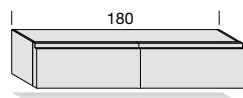

MOC1062K

1.624

mc 0,27 – Kg 53

1 CASSETTO DECORATO, 1 CASSETTO
1 DECORATED DRAWER, 1 DRAWER

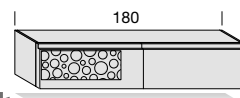

*

MOC1072K

1.785

mc 0,27 – Kg 53

1 CESTONE
1 BASKET



MOC1122K

1.203

mc 0,28 – Kg 39

1 CESTONE DECORATO
1 DECORATED BASKET

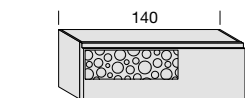

*

MOC1132K

1.389

mc 0,28 – Kg 39

2 CESTONI
2 BASKETS

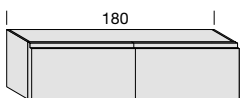

MOC1142K

1.702

mc 0,36 – Kg 52

1 CESTONE DECORATO, 1 CESTONE
1 DECORATED BASKET, 1 BASKET

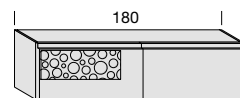

*

MOC1152K

1.870

mc 0,36 – Kg 52

1 ANTA CON DECORO, 1 RIPIANO VETRO
1 DECORATION DOOR, 1 GLASS SHELF

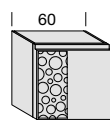

*

MOC1182K
MOC1282K

1.064

mc 0,18 – Kg 23

OPTIONAL
OPTIONAL

KIT SPORTELLINO PASSACAVI
+ BORCHIA
KIT FOR CABLE MANAGEMENT HOLE
+ COVER

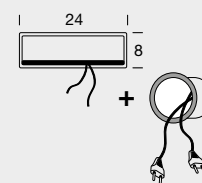

ZZZFE22005

133

*
SPECIFICARE SEMPRE IL TIPO DI
DECORO IL PREZZO È LO STESSO
(RAPPRESENTATO DECORO
CERCHIO)

ALWAYS INDICATE THE TYPE OF
DECORATION, IT IS THE SAME
PRICE (CIRCLE DECORATION
REPRESENTED)



CIRCLE DECORATION GEOMETRIC DECORATION

POSSIBILITÀ DI TOP CON COLORE
DIVERSO DALLA STRUTTURA, SENZA
MAGGIORAZIONE DI PREZZO

POSSIBILITY OF TOP WITH
DIFFERENT COLOR FROM THE
CARCASE, WITHOUT SURCHARGE

MOON SISTEMA COMPONIBILE - MODULAR SYSTEM

BASI SOSPENSE P. 50

SUSPENDED BASE UNIT D. 50

BASI H. 30 BASE UNIT H. 30

1 CASSETTO
1 DRAWER

1 CASSETTO DECORATO
1 DECORATED DRAWER

1 CASSETTO
1 DRAWER

1 CASSETTO DECORATO
1 DECORATED DRAWER

AGGIUNGERE TOP
OBBLIGATORIO NON
COMPRESO NEL PREZZO
DELLA BASE VEDI PAG. 35

ADD COMPULSORY TOP NOT
INCLUDED IN THE PRICE OF
BASE UNIT SEE PAGE 35

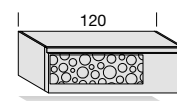
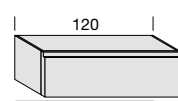
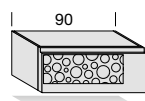
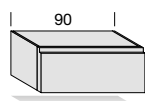

MOC1502K

MOC1512K

MOC1522K

MOC1532K

FRASSINO / ASHWOOD

760

999

1.041

1.227

mc 0,18 – Kg 27

mc 0,18 – Kg 27

mc 0,23 – Kg 30

mc 0,23 – Kg 30

BASI H. 40 BASE UNIT H. 40

1 CESTONE
1 BASKET

1 CESTONE DECORATO
1 DECORATED BASKET

1 CESTONE
1 BASKET

1 CESTONE DECORATO
1 DECORATED BASKET

AGGIUNGERE TOP
OBBLIGATORIO NON
COMPRESO NEL PREZZO
DELLA BASE VEDI PAG. 35

ADD COMPULSORY TOP NOT
INCLUDED IN THE PRICE OF
BASE UNIT SEE PAGE 35

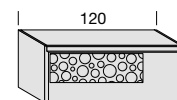
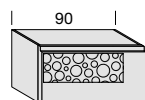
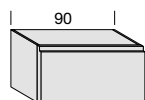

MOC1582K

MOC1592K

MOC1602K

MOC1612K

FRASSINO / ASHWOOD

1.047

1.245

1.143

1.336

mc 0,23 – Kg 32

mc 0,23 – Kg 32

mc 0,30 – Kg 41

mc 0,30 – Kg 41

BASI H. 60 BASE UNIT H. 60

1 ANTA, 1 RIPIANO VETRO
1 DOOR, 1 GLASS SHELF

1 ANTA CON DECORO, 1 RIPIANO VETRO
1 DECORATION DOOR, 1 GLASS SHELF

AGGIUNGERE TOP
OBBLIGATORIO NON
COMPRESO NEL PREZZO
DELLA BASE VEDI PAG. 35

ADD COMPULSORY TOP NOT
INCLUDED IN THE PRICE OF
BASE UNIT SEE PAGE 35

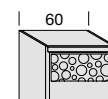
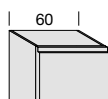

DX / RH
SX / LH

MOC1662K
MOC1762K

MOC1672K
MOC1772K

FRASSINO / ASHWOOD

962

1.089

mc 0,22 – Kg 29

mc 0,22 – Kg 29

1 CASSETTO
1 DRAWER

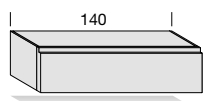

MOC1542K

925

mc 0,27 - Kg 35

1 CASSETTO DECORATO
1 DECORATED DRAWER

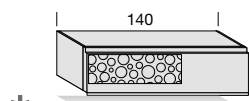

*

MOC1552K

1.328

mc 0,27 - Kg 35

2 CASSETTI
2 DRAWERS

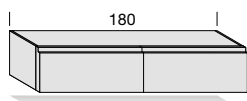

MOC1562K

1.696

mc 0,35 - Kg 53

1 CASSETTO DECORATO, 1 CASSETTO
1 DECORATED DRAWER, 1 DRAWER

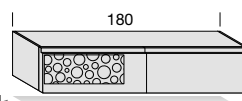

*

MOC1572K

1.864

mc 0,35 - Kg 53

1 CESTONE
1 BASKET



MOC1622K

1.250

mc 0,35 - Kg 49

1 CESTONE DECORATO
1 DECORATED BASKET

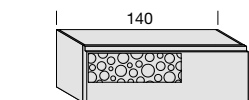

*

MOC1632K

1.438

mc 0,35 - Kg 49

2 CESTONI
2 BASKETS

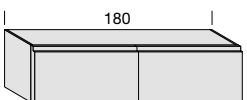

MOC1642K

1.768

mc 0,44 - Kg 66

1 CESTONE DECORATO, 1 CESTONE
1 DECORATED BASKET, 1 BASKET

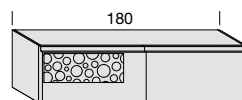

*

MOC1652K

1.930

mc 0,44 - Kg 66

1 ANTA CON DECORO, 1 RIPIANO VETRO
1 DECORATION DOOR, 1 GLASS SHELF

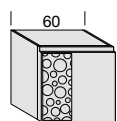

*

MOC1682K
MOC1782K

1.089

mc 0,22 - Kg 29

OPTIONAL
OPTIONAL

KIT SPORTELLINO PASSACAVI
+ BORCHIA
KIT FOR CABLE MANAGEMENT HOLE
+ COVER

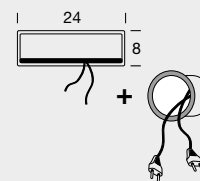

ZZZFE22005

133

*
SPECIFICARE SEMPRE IL TIPO DI
DECORO IL PREZZO È LO STESSO
(RAPPRESENTATO DECORO
CERCHIO)

ALWAYS INDICATE THE TYPE OF
DECORATION, IT IS THE SAME
PRICE (CIRCLE DECORATION
REPRESENTED)



CIRCLE DECORATION GEOMETRIC DECORATION

POSSIBILITÀ DI TOP CON COLORE
DIVERSO DALLA STRUTTURA, SENZA
MAGGIORAZIONE DI PREZZO

POSSIBILITY OF TOP WITH
DIFFERENT COLOR FROM THE
CARCASE, WITHOUT SURCHARGE

MOON SISTEMA COMPONIBILE - MODULAR SYSTEM

PENSILI ORIZZONTALI P. 40

HORIZONTAL WALL UNITS D. 40

PENSILI H. 40
WALL UNITS H. 40

1 RIBALTA LEGNO
1 WOODEN DROP-DOWN DOOR

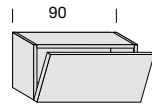

MOC2081K

1.004

mc 0,17 – Kg 21

1 RIBALTA DECORATA
1 DECORATED DROP-DOWN DOOR

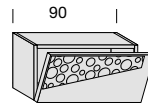

MOC2091K

1.197

mc 0,17 – Kg 21

1 RIBALTA VETRO
1 GLASS DROP-DOWN DOOR

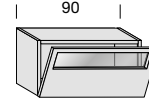

MOC2351K

1.240

+ 37
mc 0,17 – Kg 21

1 RIBALTA VETRO
1 GLASS DROP-DOWN DOOR

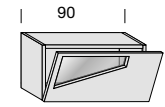

MOC2161K

1.203

+ 37
mc 0,17 – Kg 21

*

VETRO TRASPARENTE
TRANSPARENT GLASS

VETRO TRASPARENTE
TRANSPARENT GLASS

FRASSINO / ASHWOOD
Vetro fumé / Smoked glass

1 RIBALTA LEGNO
1 WOODEN DROP-DOWN DOOR

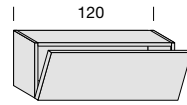

MOC2101K

1.160

mc 0,20 – Kg 26

1 RIBALTA DECORATA
1 DECORATED DROP-DOWN DOOR

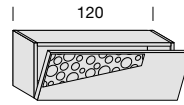

MOC2111K

1.353

mc 0,20 – Kg 26

1 RIBALTA VETRO
1 GLASS DROP-DOWN DOOR

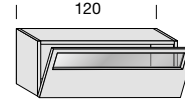

MOC2361K

1.401

+ 61
mc 0,20 – Kg 26

1 RIBALTA VETRO
1 GLASS DROP-DOWN DOOR

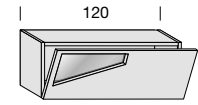

MOC2171K

1.341

+ 37
mc 0,20 – Kg 26

*

VETRO TRASPARENTE
TRANSPARENT GLASS

VETRO TRASPARENTE
TRANSPARENT GLASS

FRASSINO / ASHWOOD
Vetro fumé / Smoked glass

1 RIBALTA LEGNO
1 WOODEN DROP-DOWN DOOR

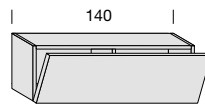

MOC2121K

1.257

mc 0,27 – Kg 29

1 RIBALTA DECORATA
1 DECORATED DROP-DOWN DOOR

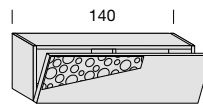

MOC2131K

1.443

mc 0,27 – Kg 29

1 RIBALTA VETRO
1 GLASS DROP-DOWN DOOR

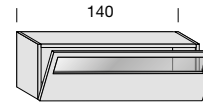

MOC2371K

1.491

+ 67
mc 0,27 – Kg 29

1 RIBALTA VETRO
1 GLASS DROP-DOWN DOOR

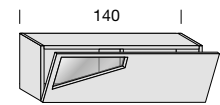

MOC2181K

1.432

+ 37
mc 0,27 – Kg 29

*

VETRO TRASPARENTE
TRANSPARENT GLASS

VETRO TRASPARENTE
TRANSPARENT GLASS

FRASSINO / ASHWOOD
Vetro fumé / Smoked glass

1 RIBALTA LEGNO
1 WOODEN DROP-DOWN DOOR

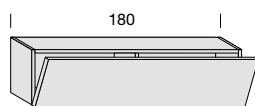

MOC2141K

1.365

mc 0,34 – Kg 36

1 RIBALTA DECORATA
1 DECORATED DROP-DOWN DOOR

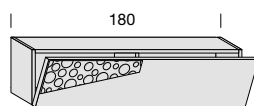

MOC2151K

1.569

mc 0,34 – Kg 36

1 RIBALTA VETRO
1 GLASS DROP-DOWN DOOR

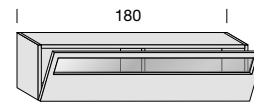

MOC2381K

1.605

+ 79
mc 0,34 – Kg 36

1 RIBALTA VETRO
1 GLASS DROP-DOWN DOOR

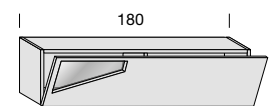

MOC2191K

1.545

+ 37
mc 0,34 – Kg 36

*

VETRO TRASPARENTE
TRANSPARENT GLASS

VETRO TRASPARENTE
TRANSPARENT GLASS

FRASSINO / ASHWOOD
Vetro fumé / Smoked glass

1 VASISTAS LEGNO
1 WOODEN LIFT-UP DOOR

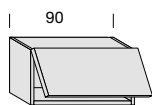

MOC2001K

1.004

mc 0,17 – Kg 21

1 VASISTAS DECORATA
1 DECORATED LIFT-UP DOOR

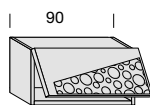

MOC2011K

1.197

mc 0,17 – Kg 21

1 VASISTAS VETRO
1 GLASS LIFT-UP DOOR

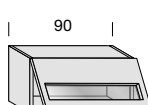

MOC2301K

1.240

+ 37
mc 0,17 – Kg 21

VETRO TRASPARENTE
TRANSPARENT GLASS

1 VASISTAS VETRO
1 GLASS LIFT-UP DOOR

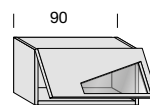

MOC2221K

1.179

+ 37
mc 0,17 – Kg 21

VETRO TRASPARENTE
TRANSPARENT GLASS

*

1 VASISTAS LEGNO
1 WOODEN LIFT-UP DOOR

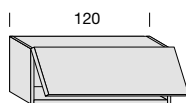

MOC2021K

1.160

mc 0,20 – Kg 26

1 VASISTAS DECORATA
1 DECORATED LIFT-UP DOOR

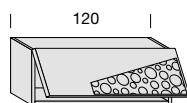

MOC2031K

1.353

mc 0,20 – Kg 26

*

1 VASISTAS VETRO
1 GLASS LIFT-UP DOOR

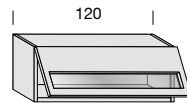

MOC2311K

1.401

+ 61
mc 0,20 – Kg 26

VETRO TRASPARENTE
TRANSPARENT GLASS

1 VASISTAS VETRO
1 GLASS LIFT-UP DOOR

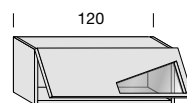

MOC2231K

1.341

+ 37
mc 0,20 – Kg 26

VETRO TRASPARENTE
TRANSPARENT GLASS

1 VASISTAS LEGNO
1 WOODEN LIFT-UP DOOR

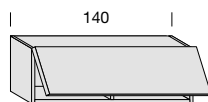

MOC2041K

1.257

mc 0,27 – Kg 29

1 VASISTAS DECORATA
1 DECORATED LIFT-UP DOOR

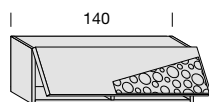

MOC2051K

1.443

mc 0,27 – Kg 29

*

1 VASISTAS VETRO
1 GLASS LIFT-UP DOOR

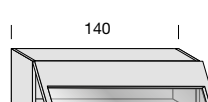

MOC2321K

1.491

+ 67
mc 0,27 – Kg 29

VETRO TRASPARENTE
TRANSPARENT GLASS

1 VASISTAS VETRO
1 GLASS LIFT-UP DOOR

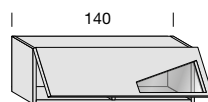

MOC2241K

1.432

+ 37
mc 0,27 – Kg 29

VETRO TRASPARENTE
TRANSPARENT GLASS

1 VASISTAS LEGNO
1 WOODEN LIFT-UP DOOR

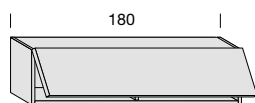

MOC2061K

1.365

mc 0,34 – Kg 36

1 VASISTAS DECORATA
1 DECORATED LIFT-UP DOOR

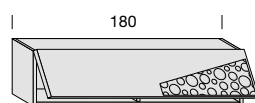

MOC2071K

1.569

mc 0,34 – Kg 36

*

1 VASISTAS VETRO
1 GLASS LIFT-UP DOOR

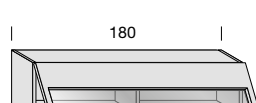

MOC2331K

1.605

+ 79
mc 0,34 – Kg 36

VETRO TRASPARENTE
TRANSPARENT GLASS

1 VASISTAS VETRO
1 GLASS LIFT-UP DOOR

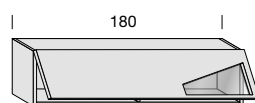

MOC2251K

1.545

+ 37
mc 0,34 – Kg 36

VETRO TRASPARENTE
TRANSPARENT GLASS

**OPTIONAL
OPTIONAL**

BARRA LED A BASSO CONSUMO
ACCENSIONE TOUCH
IN ALLUMINIO L. 37.2
LOW CONSUMPTION LED BAR
TOUCH SWITCH
IN ALUMINIUM W. 37.2



ZZZFE22001

163

ALIMENTATORE
POWER SUPPLY



ZZZFE22002

67

COLLEGAMENTO
A CARICO DEL CLIENTE
CONNECTIONS
TO BE MADE BY THE CUSTOMER.

*
SPECIFICARE SEMPRE IL TIPO DI
DECORO IL PREZZO È LO STESSO
(RAPPRESENTATO DECORO
CERCHIO)
ALWAYS INDICATE THE TYPE OK
DECORATION, IT IS THE SAME
PRICE (CIRCLE DECORATION
REPRESENTED)

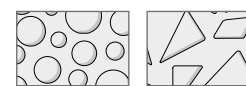

CIRCLE DECORATION GEOMETRIC DECORATION

MOON SISTEMA COMPONIBILE - MODULAR SYSTEM

PENSILI ORIZZONTALI P. 40

HORIZONTAL WALL UNITS D. 40

PENSILI H. 40 WALL UNITS H. 40

1 RIBALTA LEGNO E VANO A GIORNO
1 WOODEN DROP-DOWN DOOR AND
OPEN COMPARTMENT

1 RIBALTA DECORATA E VANO A GIORNO
1 DECORATED DROP-DOWN DOOR AND
OPEN COMPARTMENT

1 RIBALTA VETRO E VANO A GIORNO
1 GLASS DROP-DOWN DOOR AND OPEN
COMPARTMENT

1 VASISTAS LEGNO E VANO A GIORNO
1 WOODEN LIFT-UP DOOR AND OPEN
COMPARTMENT

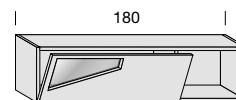
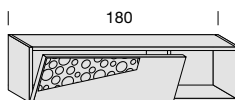
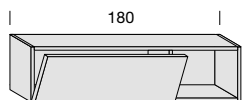

*

VETRO TRASPARENTE
TRANSPARENT GLASS

vano a giorno DX / RH open compartment
vano a giorno SX / LH open compartment

MOC2261K
MOC2262K

MOC2271K
MOC2272K

MOC2291K
MOC2292K

MOC2201K
MOC2202K

FRASSINO / ASHWOOD

1.318

1.516

1.486

1.318

Vetro fumé / Smoked glass

+ 30

mc 0,34 – Kg 34

mc 0,34 – Kg 34

mc 0,34 – Kg 34

mc 0,34 – Kg 34

PENSILI A GIORNO P. 30 OPEN WALL UNITS D. 30

PENSILI H. 20 WALL UNITS H. 20

A GIORNO CON 3 VANI
OPEN WITH 3 COMPARTMENTS

A GIORNO CON 3 VANI
OPEN WITH 3 COMPARTMENTS

A GIORNO CON 3 VANI
OPEN WITH 3 COMPARTMENTS

A GIORNO CON 3 VANI
OPEN WITH 3 COMPARTMENTS

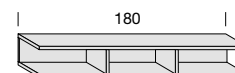
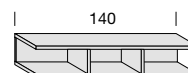
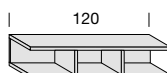
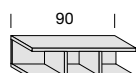

MOC2801K

MOC2811K

MOC2821K

MOC2831K

FRASSINO / ASHWOOD

559

710

727

831

mc 0,08 – Kg 12

mc 0,12 – Kg 15

mc 0,14 – Kg 17

mc 0,17 – Kg 21

RASTER H. 60 RASTER H. 60

A GIORNO CON 3 VANI
OPEN WITH 3 COMPARTMENTS

A GIORNO CON 3 VANI
OPEN WITH 3 COMPARTMENTS

A GIORNO CON 3 VANI
OPEN WITH 3 COMPARTMENTS

A GIORNO CON 3 VANI
OPEN WITH 3 COMPARTMENTS

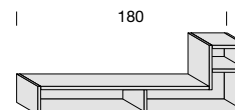
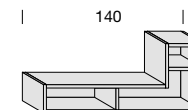
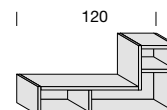
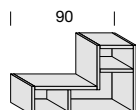

MOC2841K

MOC2851K

MOC2861K

MOC2871K

FRASSINO / ASHWOOD

698

813

854

1.034

mc 0,26 – Kg 25

mc 0,34 – Kg 30

mc 0,40 – Kg 38

mc 0,52 – Kg 46

1 VASISTAS DECORATA E VANO A GIORNO
1 DECORATED LIFT-UP DOOR AND OPEN COMPARTMENT

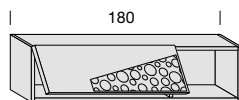

1 VASISTAS VETRO E VANO A GIORNO
1 GLASS LIFT-UP DOOR AND OPEN COMPARTMENT

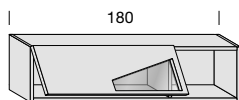

*

MOC2211K
MOC2212K

1.516

mc 0,34 – Kg 34

VETRO TRASPARENTE
TRANSPARENT GLASS

MOC2281K
MOC2282K

1.486

+ 37

mc 0,34 – Kg 34

**OPTIONAL
OPTIONAL**

**BARRA LED A BASSO CONSUMO
ACCENSIONE TOUCH
IN ALLUMINIO L. 37.2**
LOW CONSUMPTION LED BAR
TOUCH SWITCH
IN ALUMINIUM W. 37.2



ZZZFE22001

163

**ALIMENTATORE
POWER SUPPLY**



ZZZFE22002

67

**COLLEGAMENTO
A CARICO DEL CLIENTE**
CONNECTIONS
TO BE MADE BY THE CUSTOMER.

*

**SPECIFICARE SEMPRE IL TIPO DI
DECORO IL PREZZO È LO STESSO
(RAPPRESENTATO DECORO
CERCHIO)**

**ALWAYS INDICATE THE TYPE OF
DECORATION, IT IS THE SAME
PRICE (CIRCLE DECORATION
REPRESENTED)**

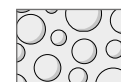

CIRCLE DECORATION



GEOMETRIC DECORATION

A GIORNO CON 3 VANI
OPEN WITH 3 COMPARTMENTS

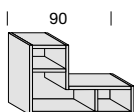

MOC2842K

698

mc 0,26 – Kg 25

A GIORNO CON 3 VANI
OPEN WITH 3 COMPARTMENTS

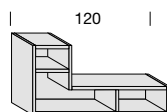

MOC2852K

813

mc 0,34 – Kg 30

A GIORNO CON 3 VANI
OPEN WITH 3 COMPARTMENTS

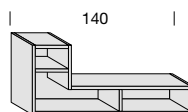

MOC2862K

854

mc 0,40 – Kg 38

A GIORNO CON 3 VANI
OPEN WITH 3 COMPARTMENTS

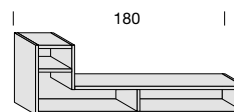

MOC2872K

1.034

mc 0,52 – Kg 46

MOON SISTEMA COMPONIBILE - MODULAR SYSTEM

PENSILI VERTICALI P. 40 VERTICAL WALL UNITS D. 40

PENSILI H. 60 WALL UNITS H. 60

1 ANTA LEGNO, 1 RIPIANO VETRO
1 WOODEN DOOR, 1 GLASS SHELF

1 ANTA DECORATA, 1 RIPIANO VETRO
1 DECORATED DOOR, 1 GLASS SHELF

1 ANTA DECORATA, 1 RIPIANO VETRO
1 DECORATED DOOR, 1 GLASS SHELF

1 ANTA LEGNO E VETRO,
1 RIPIANO VETRO
1 WOODEN DOOR WITH GLASS,
1 GLASS SHELF

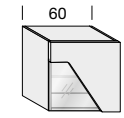
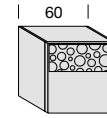
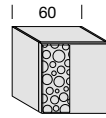
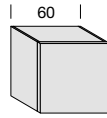

DX / RH
SX / LH

MOC2501K
MOC2601K

*

MOC2511K
MOC2611K

*

MOC2561K
MOC2661K

VETRO TRASPARENTE
TRANSPARENT GLASS

MOC2521K
MOC2621K

FRASSINO / ASHWOOD
Vetro fumé / Smoked glass

831

999

999

975

+ **54**

mc 0,17 – Kg 19

mc 0,17 – Kg 19

mc 0,17 – Kg 19

mc 0,17 – Kg 19

PENSILI 80x80 WALL UNITS 80x80

1 ANTA LEGNO SX, 1 VASISTAS LEGNO
1 LH WOODEN DOOR, 1 WOODEN LIFT-UP
DOOR

1 ANTA LEGNO DX, 1 VASISTAS LEGNO
1 RH WOODEN DOOR, 1 WOODEN LIFT-
UP DOOR

1 ANTA LEGNO SX, 1 RIBALTA LEGNO
1 LH WOODEN DOOR, 1 WOODEN DROP-
DOWN DOOR

1 ANTA LEGNO DX, 1 RIBALTA LEGNO
1 RH WOODEN DOOR, 1 WOODEN DROP-
DOWN DOOR

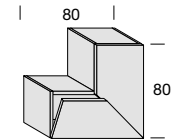
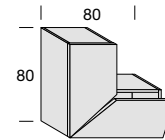
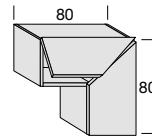
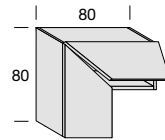

MOC2691K

MOC2591K

MOC2901K

MOC2701K

FRASSINO / ASHWOOD

1.288

1.288

1.288

1.288

mc 0,31 – Kg 40

mc 0,31 – Kg 40

mc 0,31 – Kg 40

mc 0,31 – Kg 40

TOTEM H. 160 TOTEM H. 160

2 ANTE LEGNO, 2 RIPIANI VETRO E VANO
A GIORNO
2 WOODEN DOORS, 2 GLASS SHELVES
AND OPEN COMPARTMENT

2 ANTE DECORATE, 2 RIPIANI VETRO E
VANO A GIORNO
2 DECORATED DOORS, 2 GLASS SHELVES
AND OPEN COMPARTMENT

2 ANTE DECORATE, 2 RIPIANI VETRO E
VANO A GIORNO
2 DECORATED DOORS, 2 GLASS SHELVES
AND OPEN COMPARTMENT

2 ANTE LEGNO E VETRO TRASPARENTE, 2
RIPIANI VETRO E VANO A GIORNO
2 WOODEN DOORS WITH TRANSPARENT
GLASS AND OPEN COMPARTMENT, 2
GLASS SHELVES

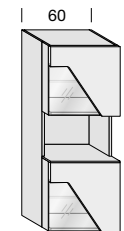
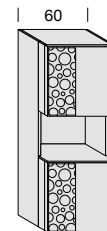
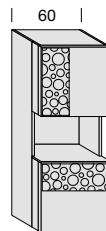
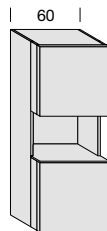

DX / RH
SX / LH

MOC2531K
MOC2631K

OPTIONAL
RIPIANO SHELF

*

MOC2541K
MOC2641K

OPTIONAL
RIPIANO SHELF

MOC2581K
MOC2681K

OPTIONAL
RIPIANO SHELF

VETRO TRASPARENTE
TRANSPARENT GLASS

MOC2551K
MOC2651K

OPTIONAL
RIPIANO SHELF

FRASSINO / ASHWOOD
Vetro fumé / Smoked glass

1.858

2.170

2.170

2.129

+ **110**

+ **30**

+ **30**

+ **30**

+ **30**

mc 0,47 – Kg 48

mc 0,01 – Kg 1

mc 0,47 – Kg 48

mc 0,01 – Kg 1

mc 0,47 – Kg 48

mc 0,01 – Kg 1

mc 0,47 – Kg 48

mc 0,01 – Kg 1

PENSILI H. 120 WALL UNITS H. 120

1 ANTA VETRO SX
1 LH GLASS DOOR

1 ANTA VETRO DX
1 RH GLASS DOOR

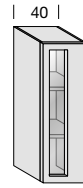
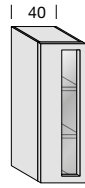

VETRO TRASPARENTE
TRANSPARENT GLASS

MOC2402K

VETRO TRASPARENTE
TRANSPARENT GLASS

MOC2401K

FRASSINO / ASHWOOD

Vetro fumé / Smoked glass

1.245

+ 61

mc 0,23 – Kg 24

1.245

+ 61

mc 0,23 – Kg 24

OPTIONAL OPTIONAL

BARRA LED A BASSO CONSUMO
ACCENSIONE TOUCH
IN ALLUMINIO L. 37.2
LOW CONSUMPTION LED BAR
TOUCH SWITCH
IN ALUMINIUM W. 37.2



ZZZFE22001

163

ALIMENTATORE
POWER SUPPLY



ZZZFE22002

67

COLLEGAMENTO
A CARICO DEL CLIENTE
CONNECTIONS
TO BE MADE BY THE CUSTOMER.



SHELF

GLASS SHELF SP. 0,8 FOR TECA COMPARTMENT

*
SPECIFICARE SEMPRE IL TIPO DI
DECORO IL PREZZO È LO STESSO
(RAPPRESENTATO DECORO
CERCHIO)

ALWAYS INDICATE THE TYPE OF
DECORATION, IT IS THE SAME
PRICE (CIRCLE DECORATION
REPRESENTED)

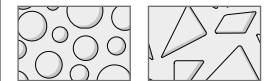

CIRCLE DECORATION GEOMETRIC DECORATION

OPTIONAL PER TOTEM H. 160 OPTIONAL FOR TOTEM H. 160

TECA IN LEGNO H. 40
WOODEN TECA H 40

TECA VETRO H. 40
GLASS TECA H 40

TECA VETRO H. 40
GLASS TECA H 40

RIPIANO IN LEGNO SP. 0,8
WOODEN SHELF SP 0,8

RIPIANO IN VETRO SP. 0,8
GLASS SHELF SP. 08,8

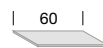
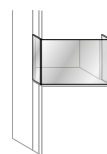
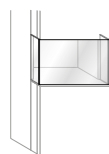
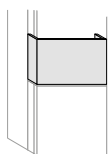

MOC2561C

MOC2581C

MOC2571C

MOC2231C

MOC2201C

356

470

487

110

37

mc 0,06 – Kg 8

mc 0,06 – Kg 8

mc 0,06 – Kg 8

mc 0,01 – Kg 1

mc 0,01 – Kg 1

MOON SISTEMA COMPONIBILE - MODULAR SYSTEM

COMPOSIZIONI A CATALOGO

CATALOGUE COMPOSITIONS

COMPOSIZIONE 2B

COMPOSITION 2B

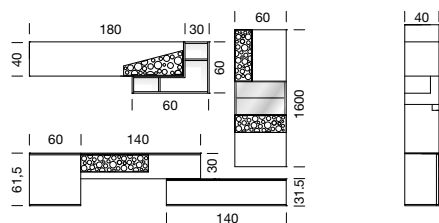
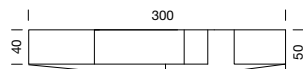

1	MOC1261K	BASE A TERRA ANTA LEGNO SX L 60 H 61,5 P 40 FLOOR-STANDING BASE UNIT WITH WOODEN DOOR LH W 60 H 61.5 D 40	938
1	MOC1052K	BASE SOSPESA CASSETTO CON DECORO L 140 H 30 P 40 SUSPENDED BASE UNIT WITH DRAWER WITH DECORATION W 140 H 30 D 40	1.288
1	MOC5031K	TOP L 200 P 40 TOP W 200 D 40	361
1	MOC1541K	BASE A TERRA CASSETTO L 140 H 31,5 P 50 FLOOR-STANDING BASE UNIT WITH DRAWER W 140 H 31.5 D 50	1.136
1	MOC5311K	TOP L 140 P 50 TOP W 140 D 50	229
1	MOC2541K	TOTEM 2 ANTE LEGNO DX CON DECORO, 2 RIPIANI VETRO L 60 H 160 TOTEM WITH 2 WOODEN DOOR RH AND DECORATION, 2 INTERNAL GLASS SHELVES W 60 H 160	2.170
1	MOC2201C	RIPIANO VETRO VANO CENTRALE TOTEM L 60 GLASS SHELF W 60	37
1	MOC2571C	TECA VETRO FUME' L 60 H 40 SMOKED GREY GLASS TECA W 60 H 40	487
1	MOC2071K	PENSILE VASISTAS ANTA LEGNO CON DECORO L 180 WALL UNIT LIFT-UP WOODEN DOOR WITH DECORATION W 120	1.569
1	MOC2841K	RASTER L 90 H 60 RASTER W 90 H 60	698
TOTALE TOTAL			8.913



L. W. 300
P. D. 50

COMPOSIZIONE 50

COMPOSITION 50

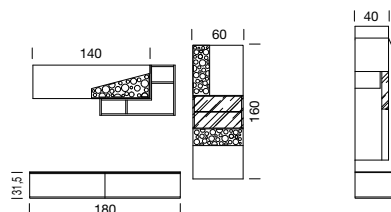

1	MOC1561K	BASE A TERRA 2 CASSETTI L 180 H 31,5 P 50 FLOOR-STANDING BASE UNIT WITH 2 DRAWERS W 180 H 31.5 D 50	1.696
1	MOC5321K	TOP L 180 P 50 TOP W 180 D 50	278
1	MOC2541K	TOTEM 2 ANTE LEGNO DX CON DECORO, 2 RIPIANI VETRO L 60 H 160 TOTEM WITH 2 WOODEN DOOR RH AND DECORATION, 2 INTERNAL GLASS SHELVES W 60 H 160	2.170
1	MOC2201C	RIPIANO VETRO VANO CENTRALE TOTEM L 60 GLASS SHELF W 60	37
1	MOC2571C	TECA VETRO FUME' L 60 H 40 SMOKED GREY GLASS TECA W 60 H 40	487
1	MOC2051K	PENSILE VASISTAS ANTA LEGNO CON DECORO L 140 WALL UNIT 1 WOODEN LIFT-UP DOOR AND DECORATION W 140	1.443
1	MOC2841K	RASTER L 90 H 60 RASTER W 90 H 60	698
TOTALE TOTAL			6.809



L. W. 260
P. D. 40/50

COMPOSIZIONE 22

COMPOSITION 22

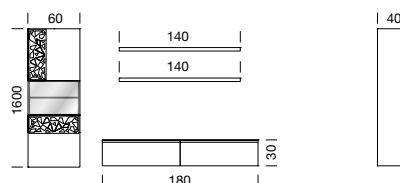
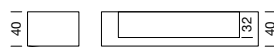

1	MOC1062K	BASE SOSPESA 2 CASSETTI L 180 H 30 P 40 SUSPENDED BASE UNIT WITH 2 DRAWERS W 180 H 30 D 40	1.624
1	MOC5021K	TOP L 180 P 40 TOP W 180 D 40	265
2	MOC3531K	MENSOLA SAGOMATA L 140 P 18/32 SHAPED SHELF W 140 D 18/32	772
1	MOC2641K	TOTEM 2 ANTE LEGNO SX CON DECORO, 2 RIPIANI VETRO L 60 H 160 TOTEM WITH 2 WOODEN DOOR LH, 2 INTERNAL GLASS SHELVES W 60 H 160	2.170
1	MOC2201C	RIPIANO VETRO VANO CENTRALE TOTEM L 60 GLASS SHELF W 60	37
1	MOC2581C	TECA VETRO TRASPARENTE L 60 H 40 TRANSPARENT GLASS TECA W 60 H 40	470
TOTALE TOTAL			5.338



L. W. 260
P. D. 40

COMPOSIZIONI A CATALOGO CATALOGUE COMPOSITIONS

COMPOSIZIONE 38 COMPOSITION 38

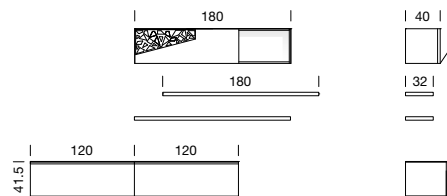
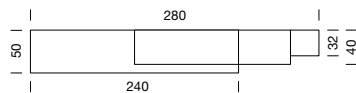

2	MOC1601K	BASE A TERRA CESTONE L 120 H 41,5 P 50 FLOOR-STANDING BASE UNIT WITH BASKET W 120 H 41,5 D 50	2.286
1	MOC5391K	TOP L 240 P 50 TOP W 240 D 50	422
2	MOC3551K	MENSOLA SAGOMATA L 180 P 18/32 SHAPED SHELF W 180 D 18/32	866
1	MOC2271K	PENSILE RIBALTA ANTA LEGNO CON DECORO E VANO A GIORNO DX L 180 WALL UNIT WITH WOODEN DROP-DOWN DOOR WITH DECORATION, AND OPEN COMPARTMENT RH W 180	1.516
TOTALE			5.090



L. W. 280
P. D. 50

COMPOSIZIONE 32 COMPOSITION 32

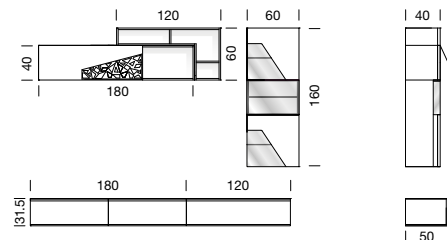
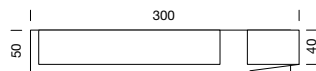

1	MOC1561K	BASE A TERRA 2 CASSETTI L 180 H 31,5 P 50 FLOOR-STANDING BASE UNIT WITH 2 DRAWERS W 180 H 31,5 D 50	1.696
1	MOC1521K	BASE A TERRA CASSETTO L 120 H 31,5 P 50 FLOOR-STANDING BASE UNIT WITH DRAWER W 120 H 31,5 D 50	1.041
1	MOC5341K	TOP L 300 P 50 TOP W 300 D 50	567
1	MOC2211K	PENSILE VASISTAS ANTA LEGNO CON DECORO E VANO A GIORNO DX L 180 WALL UNIT LIFT-UP WOODEN DOOR WITH DECORATION AND OPEN COMPARTMENT RH W 120	1.516
1	MOC2852K	RASTER L 120 H 60 RASTER W 120 H 60	813
1	MOC2551K	2 ANTE LEGNO E VETRO TRASPARENTE, 2 RIPIANI VETRO E VANO A GIORNO 2 WOODEN DOORS WITH TRANSPARENT GLASS AND OPEN COMPARTMENT, 2 GLASS SHELVES	2.189
1	MOC2201C	RIPIANO VETRO VANO CENTRALE TOTEM L 60 GLASS SHELF W 60	37
1	MOC2581C	TECA VETRO TRASPARENTE L 60 H 40 TRANSPARENT GLASS TECA W 60 H 40	470
TOTALE			8.329



L. W. 300
P. D. 50

COMPOSIZIONE 26 COMPOSITION 26

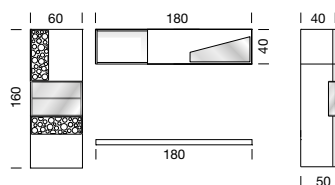
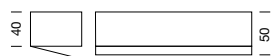

1	DCC3031K	MENSOLONE AUTOPORTANTE L 180 P 50 SELF-SUPPORTING LARGE SHELF W 180 D 50	604
1	MOC2641K	TOTEM 2 ANTE LEGNO SX CON DECORO, 2 RIPIANI VETRO L 60 H 160 TOTEM WITH 2 WOODEN DOOR LH, 2 INTERNAL GLASS SHELVES W 60 H 160	2.170
1	MOC2201C	RIPIANO VETRO VANO CENTRALE TOTEM L 60 GLASS SHELF W 60	37
1	MOC2581C	TECA VETRO TRASPARENTE L 60 H 40 TRANSPARENT GLASS TECA W 60 H 40	470
1	MOC2282K	PENSILE VASISTAS ANTA LEGNO CON VETRO E VANO A SX L 180 WALL UNIT 1 WOODEN LIFT-UP DOOR WITH GLASS AND OPEN COMPARTMENT LH W 180	1.486
TOTALE			4.767



L. W. 220
P. D. 50

MOON SISTEMA COMPONIBILE - MODULAR SYSTEM

COMPOSIZIONI A CATALOGO

CATALOGUE COMPOSITIONS

COMPOSIZIONE 34

COMPOSITION 34

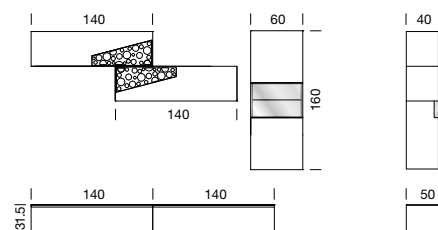
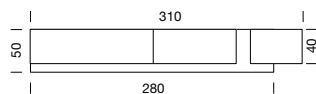

2	MOC1541K	BASE A TERRA CASSETTO L 140 H 31,5 P 50 FLOOR-STANDING BASE UNIT WITH DRAWER W 140 H 31,5 D 50	2.272
1	MOC5341K	TOP L 180 P 50 TOP W 180 D 50	567
1	MOC2051K	PENSILE VASISTAS ANTA LEGNO CON DECORO L 140 WALL UNIT 1 WOODEN LIFT-UP DOOR AND DECORATION W 140	1.443
1	MOC2131K	PENSILE RIBALTA ANTA LEGNO CON DECORO L 140 WALL UNIT 1 WOODEN DROP-DOWN DOOR AND DECORATION W 140	1.443
1	MOC2531K	TOTEM 2 ANTE LEGNO DX, 2 RIPIANI VETRO L 60 H 160 TOTEM WITH 2 WOODEN DOOR RH, 2 INTERNAL GLASS SHELVES W 60 H 160	1.858
1	MOC2201C	RIPIANO VETRO VANO CENTRALE TOTEM L 60 TOP W 240 D 50	37
1	MOC2581C	TECA VETRO TRASPARENTE L 60 H 40 TRASPARENT GLASS TECA W 60 H 40	470
TOTALE			8.090
TOTAL			



L. W. 310
P. D. 50

COMPOSIZIONE 30

COMPOSITION 30

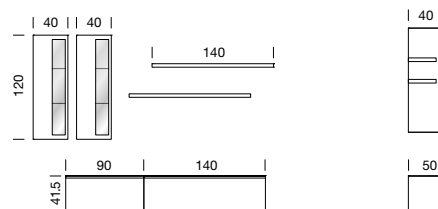
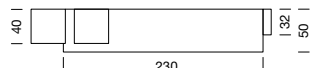

1	MOC1581K	BASE A TERRA CESTONE L 90 H 41,5 P 50 FLOOR-STANDING BASE UNIT WITH BASKET W 90 H 41,5 D 50	1.047
1	MOC1621K	BASE A TERRA CESTONE L 140 H 41,5 P 50 FLOOR-STANDING BASE UNIT WITH BASKET W 140 H 41,5 D 50	1.250
1	MOC5381K	TOP L 230 P 50 TOP W 230 D 50	397
2	MOC2402K	PENSILE ANTA VETRO SX, 2 RIPIANI VETRO L 40 H 120 WALL UNIT WITH GLASS DOOR RH, 2 GLASS SHELVES W 40 H 120	2.490
2	MOC3531K	MENSOLA SAGOMATA L 140 P 18/32 SHAPED SHELF W 140 D 18/32	772
TOTALE			5.956
TOTAL			



L. W. 290
P. D. 50

COMPOSIZIONE 24

COMPOSITION 24

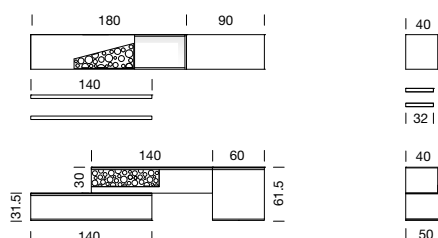
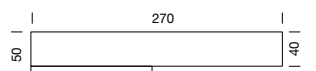

1	MOC1541K	BASE A TERRA CASSETTO L 140 H 31,5 P 50 FLOOR-STANDING BASE UNIT WITH DRAWER W 140 H 31,5 D 50	1.136
1	MOC5311K	TOP L 140 P 50 TOP W 140 D 50	229
1	MOC1052K	BASE SOSPESA CASSETTO CON DECORO L 140 H 30 P 40 SUSPENDED BASE UNIT WITH DRAWER WITH DECORATION W 140 H 30 D 40	1.288
1	MOC1161K	BASE A TERRA ANTA LEGNO DX L 60 H 61,5 P 40 FLOOR-STANDING BASE UNIT WITH RH WOODEN DOOR W 60 H 61,5 D 40	938
1	MOC5031K	TOP L 200 P 40 TOP W 200 D 40	361
2	MOC3531K	MENSOLA SAGOMATA L 140 P 18/32 SHAPED SHELF W 140 D 18/32	772
1	MOC2211K	PENSILE VASISTAS ANTA LEGNO CON DECORO E VANO A DX L 180 WALL UNIT 1 WOODEN LIFT-UP DOOR WITH DECORATION AND OPEN COMPARTMENT RH W 140	1.516
1	MOC2001K	PENSILE VASISTAS ANTA LEGNO L 90 WALL UNIT 1 WOODEN LIFT-UP DOOR W 90	1.004
TOTALE			7.244
TOTAL			



L. W. 270
P. D. 50

COMPOSIZIONI A CATALOGO CATALOGUE COMPOSITIONS

COMPOSIZIONE 40 COMPOSITION 40

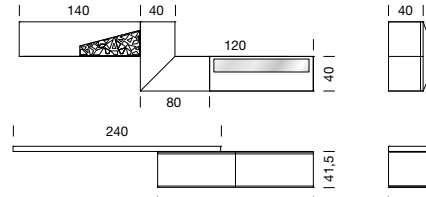
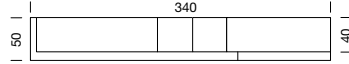

1	MOC1641K	BASE A TERRA 2 CESTONI L 180 H 41,5 P 50 FLOOR-STANDING BASE UNIT WITH 2 BASKETS W 180 H 41,5 D 50	1.768
1	MOC5321K	TOP L 180 P 50 TOP W 180 D 50	278
1	DCC3041K	MENSOLONE L 240 P 50 LARGE SHELF W 240 D 50	758
1	MOC2051K	PENSILE VASISTAS ANTA LEGNO CON DECORO L 140 WALL UNIT 1 WOODEN LIFT-UP DOOR WITH DECORATION W 140	1.443
1	MOC2901K	PENSILE 80x80 1 RIBALTA LEGNO E 1 ANTA SX WALL UNIT WITH 1 WOODEN DROP-DOWN DOOR AND 1 LH WOODEN DOOR W 80 H 80	1.288
1	MOC2361K	PENSILE RIBALTA ANTA VETRO L 120 WALL UNIT 1 GLASS DOOR W 120	1.401
TOTALE TOTAL			6.936



L. W. 340
P. D. 50

COMPOSIZIONE 28 COMPOSITION 28

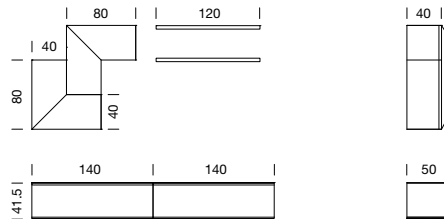
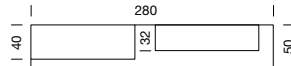

2	MOC1621K	BASE A TERRA CESTONE L 140 H 41,5 P 50 FLOOR-STANDING BASE UNIT WITH BASKET W 140 H 41,5 D 50	2.500
1	MOC5341K	TOP L 280 P 50 TOP W 140 D 50	567
1	MOC2691K	PENSILE 80x80 1 VASISTAS LEGNO E 1 ANTA SX WALL UNIT WITH 1 WOODEN DROP-DOWN DOOR AND 1 LH WOODEN DOOR W 80 H 80	1.288
1	MOC2901K	PENSILE 80x80 1 RIBALTA LEGNO E 1 ANTA SX WALL UNIT 1 WOODEN LIFT-UP DOOR AND 1 LH WOODEN DOOR W 80 H 80	1.288
2	MOC3521K	MENSOLA SAGOMATA L 120 P 18/32 SHAPED SHELF W 120 D 18/32	662
TOTALE TOTAL			6.305



L. W. 280
P. D. 50

COMPOSIZIONE 36 COMPOSITION 36

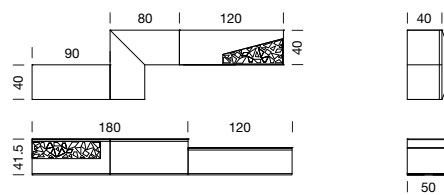
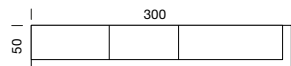

1	MOC1651K	BASE A TERRA 2 CESTONI CON DECORO L 180 H 41,5 P 50 FLOOR-STANDING BASE UNIT WITH 2 BASKETS AND DECORATION W 180 H 41,5 D 50	1.930
1	MOC5321K	TOP L 180 P 50 TOP W 180 D 50	278
1	MOC1521K	BASE A TERRA CASSETTO L 120 H 31,5 P 50 FLOOR-STANDING BASE UNIT WITH DRAWER W 120 H 31,5 D 50	1.041
1	MOC5301K	TOP L 120 P 50 TOP W 120 D 50	211
1	MOC2081K	PENSILE RIBALTA ANTA LEGNO L 90 WALL UNIT WITH 1 WOODEN DROP-DOWN DOOR W 90	1.004
1	MOC2691K	PENSILE 80x80 VASISTAS LEGNO E 1 ANTA LEGNO SX WALL UNIT 1 WOODEN LIFT-UP DOOR AND 1 LH WOODEN DOOR W 80 H 80	1.288
1	MOC2031K	PENSILE VASISTAS ANTA LEGNO CON DECORO L 120 WALL UNIT 1 WOODEN LIFT-UP DOOR AND DECORATION W 120	1.353
TOTALE TOTAL			7.105



L. W. 300
P. D. 50

MOON SISTEMA COMPONIBILE - MODULAR SYSTEM

COMPOSIZIONI A CATALOGO

CATALOGUE COMPOSITIONS

COMPOSIZIONE 1

COMPOSITION 1

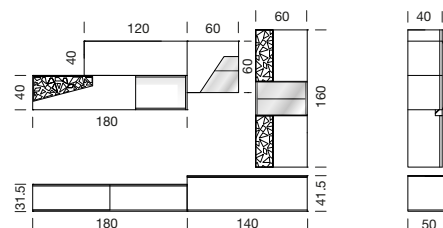
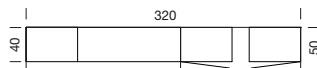

1	MOC1561K	BASE A TERRA 2 CASSETTI L 180 H 31,5 P 50 FLOOR-STANDING BASE UNIT WITH 2 DRAWERS W 180 H 31.5 D 50	1.696
1	MOC5321K	TOP L 180 P 50 TOP W 180 D 50	278
1	MOC1621K	BASE A TERRA CESTONE L 140 H 41,5 P 50 FLOOR-STANDING BASE UNIT WITH BASKET W 140 H 41.5 D 50	1.250
1	MOC5311K	TOP L 140 P 50 TOP W 140 D 50	229
1	MOC2581K	TOTEM 2 ANTE LEGNO DX CON DECORO, 2 RIPIANI INTERNI VETRO L 60 H 160 TOTEM WITH 2 WOODEN DOOR RH AND DECORATION, 2 INTERNAL GLASS SHELVES W 60 H 160	2.170
1	MOC2571C	TECA IN VETRO FUMÉ PER TOTEM L 60 H 40 FUMÉ GLASS TECA FOR TOTEM W 60 H 40	487
1	MOC2201C	RIPIANO VETRO VANO CENTRALE TOTEM L 60 GLASS SHELF W 60	37
1	MOC2621K	PENSILE ANTA LEGNO E VETRO FUMÉ SX L 60 H 60 WALL UNIT WITH WOODEN AND FUMÉ GLASS DOOR LH	1.029
1	MOC2021K	PENSILE VASISTAS ANTA LEGNO L 120 WALL UNIT LIFT-UP WOODEN DOOR W 120	1.160
1	MOC2271K	PENSILE RIBALTA ANTA LEGNO CON DECORO E VANO A GIORNO DX L 180 WALL UNIT WITH WOODEN DROP-DOWN DOOR WITH DECORATION, AND OPEN COMPARTMENT RH W 180	1.516
PREZZO TOTALE TOTAL PRICE			9.852



L. W. 320
P. D. 50

COMPOSIZIONE 2A

COMPOSITION 2A

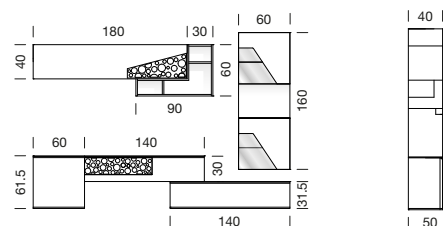
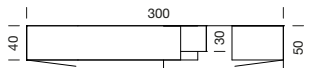

1	MOC1261K	BASE A TERRA ANTA LEGNO SX L 60 H 61,5 P 40 FLOOR-STANDING BASE UNIT WITH WOODEN DOOR LH W 60 H 61.5 D 40	938
1	MOC1052K	BASE SOSPESA CASSETTO CON DECORO L 140 H 30 P 40 SUSPENDED BASE UNIT WITH DRAWER WITH DECORATION W 140 H 30 D 40	1.288
1	MOC5031K	TOP L 200 P 40 TOP W 200 D 40	361
1	MOC1541K	BASE A TERRA CASSETTO L 140 H 31,5 P 50 FLOOR-STANDING BASE UNIT WITH DRAWER W 140 H 31.5 D 50	1.136
1	MOC5311K	TOP L 140 P 50 TOP W 140 D 50	229
1	MOC2551K	TOTEM 2 ANTE LEGNO DX CON VETRO FUMÉ, 2 RIPIANI INTERNI VETRO L 60 H 160 TOTEM WITH 2 WOODEN AND FUMÉ GLASS DOOR RH AND DECORATION, 2 INTERNAL GLASS SHELVES W 60 H 160	2.239
1	MOC2561C	TECA IN LEGNO PER TOTEM L 60 H 40 WOODEN TECA FOR TOTEM W 60 H 40	356
1	MOC2201C	RIPIANO VETRO VANO CENTRALE TOTEM L 60 GLASS SHELF W 60	37
1	MOC2841K	RASTER L 90 H 60 RASTER W 90 H 60	698
1	MOC2071K	PENSILE VASISTAS ANTA LEGNO CON DECORO L 180 WALL UNIT LIFT-UP WOODEN DOOR WITH DECORATION W 120	1.569
PREZZO TOTALE TOTAL PRICE			8.851



L. W. 300
P. D. 50

COMPOSIZIONE 3

COMPOSITION 3

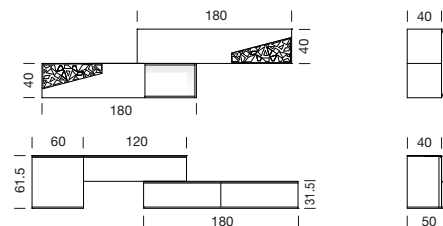
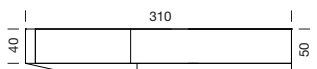

1	MOC1261K	BASE A TERRA ANTA LEGNO SX L 60 H 61,5 P 40 FLOOR-STANDING BASE UNIT WITH WOODEN DOOR LH W 60 H 61.5 D 40	938
1	MOC1022K	BASE SOSPESA CASSETTO L 120 H 30 P 40 SUSPENDED BASE UNIT WITH DRAWER W 120 H 30 D 40	1.011
1	MOC5021K	TOP L 180 P 40 TOP W 180 D 40	265
1	MOC1561K	BASE A TERRA 2 CASSETTI L 180 H 31,5 P 50 FLOOR-STANDING BASE UNIT WITH 2 DRAWERS W 180 H 31.5 D 50	1.696
1	MOC5321K	TOP L 180 P 50 TOP W 180 D 50	278
1	MOC2271K	PENSILE RIBALTA ANTA LEGNO CON DECORO E VANO A GIORNO DX L 180 WALL UNIT WITH WOODEN DROP-DOWN DOOR WITH DECORATION, AND OPEN COMPARTMENT RH W 180	1.516
1	MOC2071K	PENSILE VASISTAS ANTA LEGNO CON DECORO L 180 WALL UNIT LIFT-UP WOODEN DOOR WITH DECORATION W 120	1.569
PREZZO TOTALE TOTAL PRICE			7.273

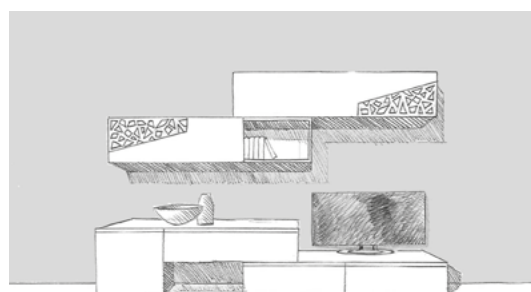

L. W. 310
P. D. 50

COMPOSIZIONI A CATALOGO CATALOGUE COMPOSITIONS

COMPOSIZIONE 4 COMPOSITION 4

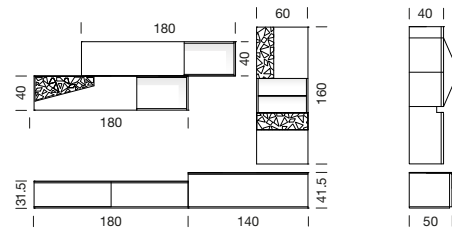
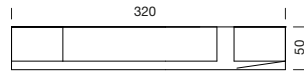

1	MOC1561K	BASE A TERRA 2 CASSETTI L 180 H 31,5 P 50 FLOOR-STANDING BASE UNIT WITH 2 DRAWERS W 180 H 31.5 D 50	1.696
1	MOC5321K	TOP L 180 P 50 TOP W 180 D 50	278
1	MOC1621K	BASE A TERRA CESTONE L 140 H 41,5 P 50 FLOOR-STANDING BASE UNIT WITH BASKET W 140 H 41.5 D 50	1.250
1	MOC5311K	TOP L 140 P 50 TOP W 140 D 50	229
1	MOC2541K	TOTEM 2 ANTE LEGNO DX CON DECORO, 2 RIPIANI INTERNI VETRO L 60 H 160 TOTEM 2 ANTE LEGNO DX CON DECORO, 2 RIPIANI INTERNI VETRO L 60 H 160	2.170
1	MOC2201C	RIPIANO VETRO VANO CENTRALE TOTEM L 60 GLASS SHELF W 60	37
1	MOC2201K	PENSILE VASISTAS ANTA LEGNO E VANO A GIORNO DX L 180 WALL UNIT LIFT-UP WOODEN DOOR W 180	1.318
1	MOC2271K	PENSILE RIBALTA ANTA LEGNO CON DECORO E VANO A GIORNO DX L 180 WALL UNIT WITH WOODEN DROP-DOWN DOOR WITH DECORATION, AND OPEN COMPARTMENT W 180	1.516
PREZZO TOTALE TOTAL PRICE			8.494

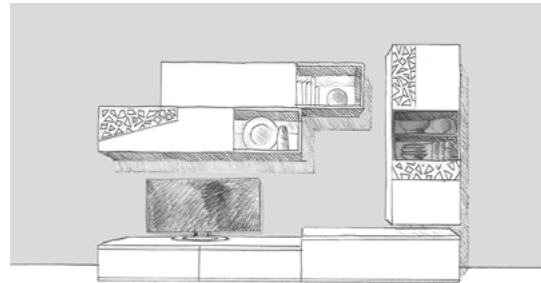

L. W. 320
P. D. 50

COMPOSIZIONE 5 COMPOSITION 5

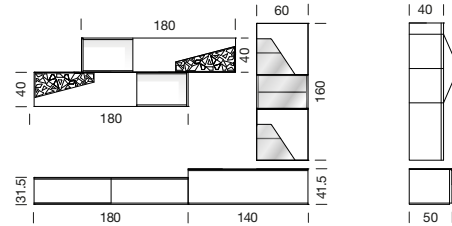
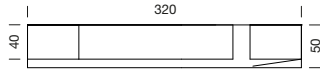

1	MOC1561K	BASE A TERRA 2 CASSETTI L 180 H 31,5 P 50 FLOOR-STANDING BASE UNIT WITH 2 DRAWERS W 180 H 31.5 D 50	1.696
1	MOC5321K	TOP L 180 P 50 TOP W 180 D 50	278
1	MOC1621K	BASE A TERRA CESTONE L 140 H 41,5 P 50 FLOOR-STANDING BASE UNIT WITH BASKET W 140 H 41.5 D 50	1.250
1	MOC5311K	TOP L 140 P 50 TOP W 140 D 50	229
1	MOC2551K	TOTEM 2 ANTE LEGNO DX CON VETRO FUMÉ, 2 RIPIANI INTERNI VETRO L 60 H 160 TOTEM WITH 2 WOODEN AND FUMÉ GLASS DOOR RH AND DECORATION, 2 INTERNAL GLASS SHELVES W 60 H 160	2.239
1	MOC2571C	TECA IN VETRO FUMÉ PER TOTEM L 60 H 40 FUMÉ GLASS TECA FOR TOTEM W 60 H 40	487
1	MOC2201C	RIPIANO VETRO VANO CENTRALE TOTEM L 60 GLASS SHELF W 60	37
1	MOC2212K	PENSILE VASISTAS ANTA LEGNO CON DECORO E VANO A GIORNO SX L 180 WALL UNIT LIFT-UP WOODEN DOOR WITH DECORATION AND OPEN COMPARTMENT LH W 180	1.516
1	MOC2271K	PENSILE RIBALTA ANTA LEGNO CON DECORO E VANO A GIORNO DX L 180 WALL UNIT WITH WOODEN DROP-DOWN DOOR WITH DECORATION, AND OPEN COMPARTMENT W 180	1.516
PREZZO TOTALE TOTAL PRICE			9.248



L. W. 320
P. D. 50

COMPOSIZIONE 6 COMPOSITION 6

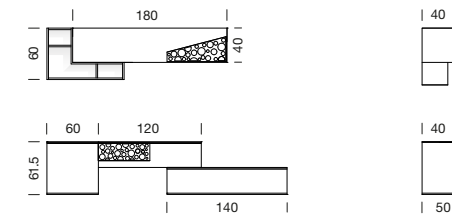
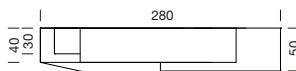

1	MOC1261K	BASE A TERRA ANTA LEGNO SX L 60 H 61,5 P 40 FLOOR-STANDING BASE UNIT WITH WOODEN DOOR LH W 60 H 61.5 D 40	938
1	MOC1032K	BASE SOSPESA CASSETTO CON DECORO L 120 H 30 P 40 SUSPENDED BASE UNIT WITH DRAWER WITH DECORATION W 120 H 30 D 40	1.191
1	MOC5021K	TOP L 180 P 40 TOP W 180 D 40	265
1	MOC1541K	BASE A TERRA CASSETTO L 140 H 31,5 P 50 FLOOR-STANDING BASE UNIT WITH DRAWER W 140 H 31.5 D 50	1.136
1	MOC5311K	TOP L 140 P 50 TOP W 140 D 50	229
1	MOC2842K	RASTER L 90 H 60 RASTER W 90 H 60	698
1	MOC2071K	PENSILE VASISTAS ANTA LEGNO CON DECORO L 180 WALL UNIT LIFT-UP WOODEN DOOR WITH DECORATION W 180	1.569
PREZZO TOTALE TOTAL PRICE			6.026



L. W. 280
P. D. 50

MOON SISTEMA COMPONIBILE - MODULAR SYSTEM

COMPOSIZIONI A CATALOGO

CATALOGUE COMPOSITIONS

COMPOSIZIONE 7

COMPOSITION 7

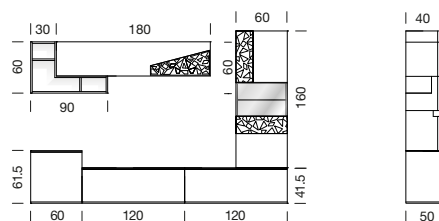
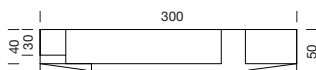

1	MOC1761K	BASE A TERRA ANTA LEGNO SX L 60 H 61,5 P 50 FLOOR-STANDING BASE UNIT WITH WOODEN DOOR LH W 60 H 61,5 D 50	962
1	MOC5351K	TOP L 60 P 50 TOP W 60 D 50	150
2	MOC1601K	BASE A TERRA CESTONE L 120 H 41,5 P 50 FLOOR-STANDING BASE UNIT WITH BASKET W 120 H 41,5 D 50	2.286
1	MOC5391K	TOP L 240 P 50 TOP W 240 D 50	422
1	MOC2541K	TOTEM 2 ANTE LEGNO DX CON DECORO, 2 RIPIANI INTERNI VETRO L 60 H 160 TOTEM WITH 2 WOODEN DOOR RH AND DECORATION, 2 INTERNAL GLASS SHELVES W 60 H 160	2.170
1	MOC2581C	TECA IN VETRO TRASPARENTE PER TOTEM L 60 H 40 TRANSPARENT GLASS TECA FOR TOTEM W 60 H 40	470
1	MOC2201C	RIPIANO VETRO VANO CENTRALE TOTEM L 60 GLASS SHELF W 60	37
1	MOC2071K	PENSILE VASISTAS ANTA LEGNO CON DECORO L 180 WALL UNIT LIFT-UP WOODEN DOOR WITH DECORATION W 180	1.569
1	MOC2842K	RASTER L 90 H 60 RASTER W 90 H 60	698
PREZZO TOTALE TOTAL PRICE			8.764

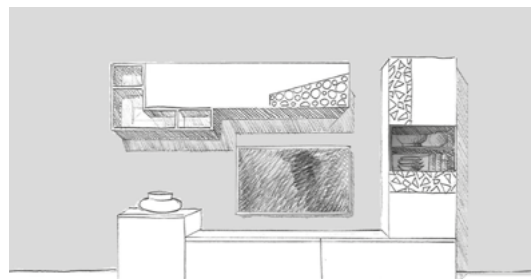

L. W. 300
P. D. 50

COMPOSIZIONE 8

COMPOSITION 8

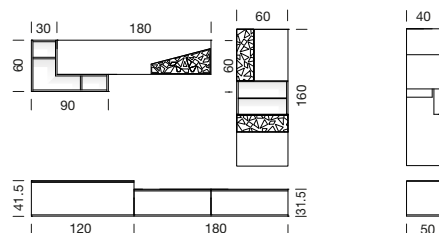
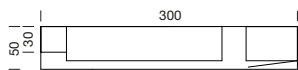

1	MOC1601K	BASE A TERRA CESTONE L 120 H 41,5 P 50 FLOOR-STANDING BASE UNIT WITH BASKET W 120 H 41,5 D 50	1.143
1	MOC5301K	TOP L 120 P 50 TOP W 120 D 50	211
1	MOC1561K	BASE A TERRA 2 CASSETTI L 180 H 31,5 P 50 FLOOR-STANDING BASE UNIT WITH 2 DRAWERS W 180 H 31,5 D 50	1.696
1	MOC5321K	TOP L 180 P 50 TOP W 180 D 50	278
1	MOC2541K	TOTEM 2 ANTE LEGNO DX CON DECORO, 2 RIPIANI INTERNI VETRO L 60 H 160 TOTEM WITH 2 WOODEN DOOR RH AND DECORATION, 2 INTERNAL GLASS SHELVES W 60 H 160	2.170
1	MOC2201C	RIPIANO VETRO VANO CENTRALE TOTEM L 60 GLASS SHELF W 60	37
1	MOC2071K	PENSILE VASISTAS ANTA LEGNO CON DECORO L 180 WALL UNIT LIFT-UP WOODEN DOOR WITH DECORATION W 180	1.569
1	MOC2842K	RASTER L 90 H 60 RASTER W 90 H 60	698
PREZZO TOTALE TOTAL PRICE			7.802

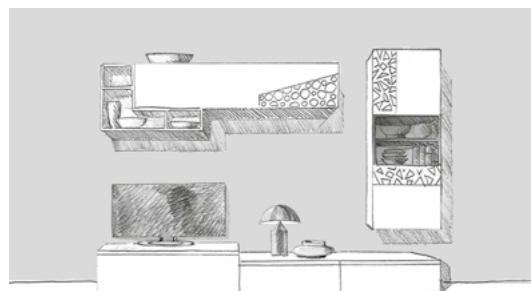

L. W. 300
P. D. 50

COMPOSIZIONE 9

COMPOSITION 9

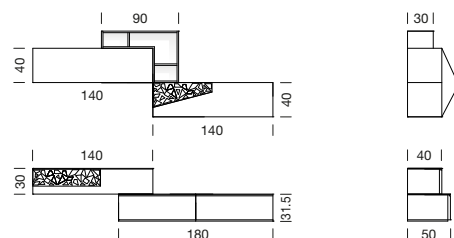
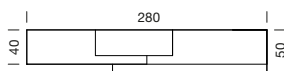

1	MOC1561K	BASE A TERRA 2 CASSETTI L 180 H 31,5 P 50 FLOOR-STANDING BASE UNIT WITH 2 DRAWERS W 180 H 31,5 D 50	1.696
1	MOC5321K	TOP L 180 P 50 TOP W 180 D 50	278
1	MOC1052K	BASE SOSPESA CASSETTO CON DECORO L 140 H 30 P 40 SUSPENDED BASE UNIT WITH DRAWER WITH DECORATION W 140 H 30 D 40	1.288
1	MOC5011K	TOP L 140 P 40 TOP W 140 D 40	217
1	MOC2131K	PENSILE RIBALTA ANTA LEGNO CON DECORO L 140 WALL UNIT WITH WOODEN DROP-DOWN DOOR WITH DECORATION W 140	1.443
1	MOC2041K	PENSILE VASISTAS ANTA LEGNO L 140 WALL UNIT LIFT-UP WOODEN DOOR W 140	1.257
1	MOC2842K	RASTER L 90 H 60 RASTER W 90 H 60	698
PREZZO TOTALE TOTAL PRICE			6.877

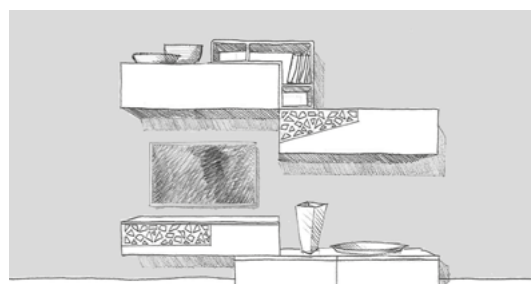

L. W. 280
P. D. 50

COMPOSIZIONI A CATALOGO CATALOGUE COMPOSITIONS

COMPOSIZIONE 10 COMPOSITION 10

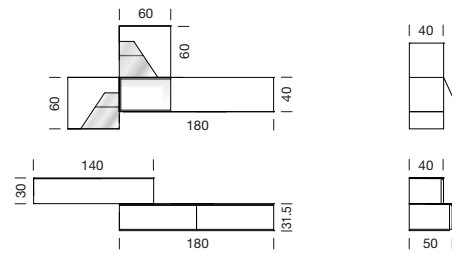
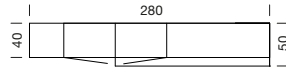

1	MOC1561K	BASE A TERRA 2 CASSETTI L 180 H 31,5 P 50 FLOOR-STANDING BASE UNIT WITH 2 DRAWERS W 180 H 31,5 D 50	1.696
1	MOC5321K	TOP L 180 P 50 TOP W 180 D 50	278
1	MOC1042K	BASE SOSPESA CASSETTO L 140 H 30 P 40 SUSPENDED BASE UNIT WITH DRAWER WITH DECORATION W 140 H 30 D 40	1.100
1	MOC5011K	TOP L 140 P 40 TOP W 140 D 40	217
1	MOC2202K	PENSILE VASISTAS ANTA LEGNO E VANO A GIORNO SX L 180 WALL UNIT WITH WOODENLIFT-UP DOOR WITH DECORATION, AND OPEN COMPARTMENT LH W 180	1.318
1	MOC2521K	PENSILE ANTA LEGNO E VETRO TRASPARENTE DX L 60 H 60 WALL UNIT WITH WOODEN AND TRANSPARENT GLASS DOOR RH W 60 H 60	975
1	MOC2621K	PENSILE ANTA LEGNO E VETRO TRASPARENTE SX L 60 H 60 WALL UNIT WITH WOODEN AND TRANSPARENT GLASS DOOR LH W 60 H 60	975
PREZZO TOTALE TOTAL PRICE			6.559

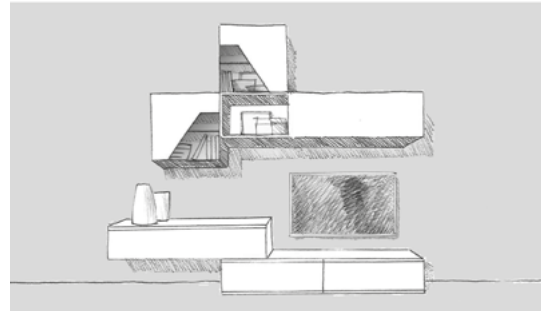

L. W. 280
P. D. 50

COMPOSIZIONE 11 COMPOSITION 11

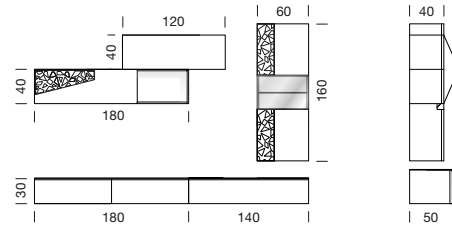
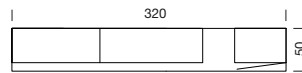

1	MOC1562K	BASE SOSPESA 2 CASSETTI L 180 H 31,5 P 50 SUSPENDED BASE UNIT WITH 2 DRAWERS W 180 H 31,5 D 50	1.696
1	MOC1542K	BASE SOSPESA 1 CASSETTO L 140 H 30 P 50 SUSPENDED BASE UNIT WITH DRAWER W 140 H 30 D 50	1.060
1	MOC5421K	TOP L 320 P 50 TOP W 320 D 50	655
1	MOC2581K	TOTEM 2 ANTE LEGNO DX CON DECORO, 2 RIPIANI INTERNI VETRO L 60 H 160 TOTEM WITH 2 WOODEN DOOR RH AND DECORATION, 2 INTERNAL GLASS SHELVES W 60 H 160	2.170
1	MOC2581C	TECA IN VETRO TRASPARENTE PER TOTEM L 60 H 40 TRANSPARENT GLASS SHELF W 60 H 40	470
1	MOC2201C	RIPIANO VETRO VANO CENTRALE TOTEM L 60 GLASS SHELF W 60	37
1	MOC2021K	PENSILE VASISTAS ANTA LEGNO L 120 WALL UNIT LIFT-UP WOODEN DOOR W 120	1.160
1	MOC2271K	PENSILE RIBALTA ANTA LEGNO CON DECORO E VANO A GIORNO DX L 180 WALL UNIT WITH WOODEN DROP-DOWN DOOR WITH DECORATION, AND OPEN COMPARTMENT RH W 180	1.516
PREZZO TOTALE TOTAL PRICE			8.764

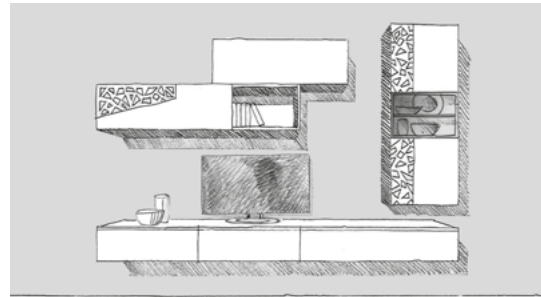

L. W. 320
P. D. 50

COMPOSIZIONE 16 COMPOSITION 16

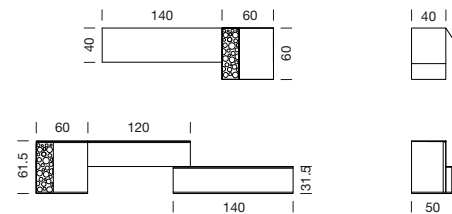
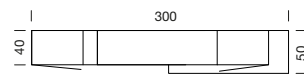

1	MOC1281K	BASE A TERRA ANTA LEGNO SX CON DECORO L 60 H 61,5 P 40 FLOOR-STANDING BASE UNIT WITH WOODEN DOOR LH WITH DECORATION W 60 H 61,5 D 40	1.064
1	MOC1022K	BASE SOSPESA CASSETTO L 120 H 30 P 40 SUSPENDED BASE UNIT WITH DRAWER W 120 H 30 D 40	1.011
1	MOC5021K	TOP L 180 P 40 TOP W 180 D 40	265
1	MOC1541K	BASE A TERRA CASSETTO L 140 H 31,5 P 50 SUSPENDED BASE UNIT WITH DRAWER WITH DECORATION W 140 H 31,5 D 50	1.136
1	MOC5311K	TOP L 140 P 50 TOP W 140 D 50	229
1	MOC2511K	PENSILE ANTA LEGNO DX CON DECORO L 60 H 60 WALL UNIT WITH WOODEN DOOR RH W 60 H 60	999
1	MOC2041K	PENSILE VASISTAS ANTA LEGNO L 140 WALL UNIT LIFT-UP WOODEN DOOR W 180	1.257
PREZZO TOTALE TOTAL PRICE			5.961

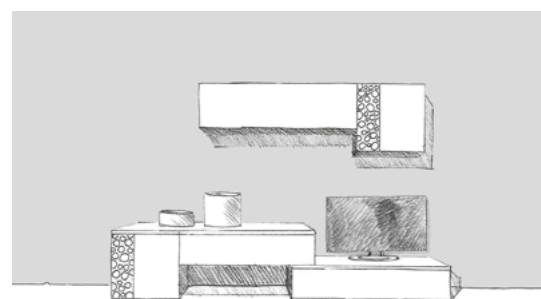

L. W. 300
P. D. 50

MOON SISTEMA COMPONIBILE - MODULAR SYSTEM

COMPOSIZIONI A CATALOGO

CATALOGUE COMPOSITIONS

COMPOSIZIONE 17

COMPOSITION 17

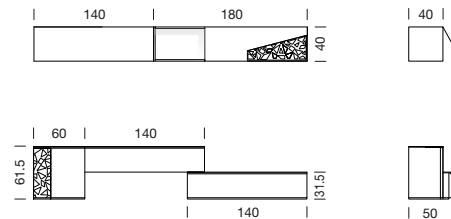
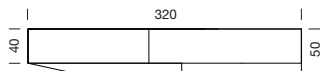

1	MOC1281K	BASE A TERRA ANTA LEGNO SX CON DECORO L 60 H 61,5 P 40 FLOOR-STANDING BASE UNIT WITH WOODEN DOOR LH WITH DECORATION W 60 H 61,5 D 40	1.064
1	MOC1042K	BASE SOSPESA CASSETTO L 140 H 30 P 40 SUSPENDED BASE UNIT WITH DRAWER WITH DECORATION W 140 H 30 D 40	1.100
1	MOC5031K	TOP L 200 P 40 TOP W 200 D 40	361
1	MOC1541K	BASE A TERRA CASSETTO L 140 H 31,5 P 50 FLOOR-STANDING BASE UNIT WITH DRAWER W 140 H 31,5 D 50	1.136
1	MOC5311K	TOP L 140 P 50 TOP W 140 D 50	229
1	MOC2041K	PENSILE VASISTAS ANTA LEGNO L 140 WALL UNIT LIFT-UP WOODEN DOOR W 140	1.257
1	MOC2212K	PENSILE VASISTAS ANTA LEGNO CON DECORO E VANO A GIORNO SX L 180 WALL UNIT LIFT-UP WOODEN DOOR AND OPEN COMPARTMENT LH W 180	1.516
PREZZO TOTALE TOTAL PRICE			6.663



L. W. 320
P. D. 50

COMPOSIZIONE 19

COMPOSITION 19

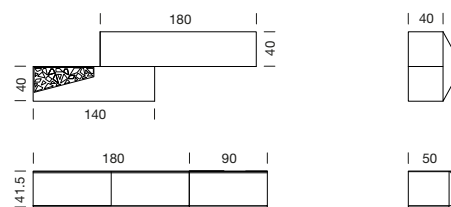
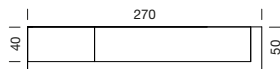

1	MOC1641K	BASE A TERRA 2 CESTONI L 180 H 41,5 P 50 FLOOR-STANDING BASE UNIT WITH 2 BASKETS W 180 H 41,5 D 50	1.768
1	MOC1581K	BASE A TERRA CESTONE L 90 H 41,5 P 50 FLOOR-STANDING BASE UNIT WITH BASKET W 90 H 41,5 D 50	1.047
1	MOC5411K	TOP L 270 P 50 TOP W 270 D 50	524
1	MOC2061K	PENSILE VASISTAS ANTA LEGNO L 180 WALL UNIT LIFT-UP WOODEN DOOR W 180	1.365
1	MOC2131K	PENSILE RIBALTA ANTA LEGNO CON DECORO L 140 WALL UNIT WITH WOODEN DROP-DOWN DOOR WITH DECORATION W 140	1.443
PREZZO TOTALE TOTAL PRICE			6.147

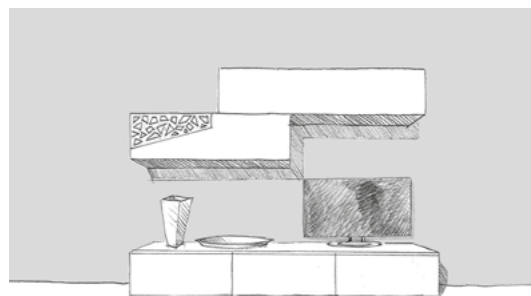

L. W. 270
P. D. 50

COMPOSIZIONE 20

COMPOSITION 20

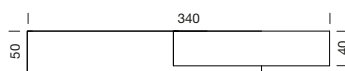

1	MOC1641K	BASE A TERRA 2 CESTONI L 180 H 41,5 P 50 FLOOR-STANDING BASE UNIT WITH 2 BASKETS W 180 H 41,5 D 50	1.768
1	MOC1581K	BASE A TERRA CESTONE L 90 H 41,5 P 50 FLOOR-STANDING BASE UNIT WITH BASKET W 90 H 41,5 D 50	1.047
1	MOC5411K	TOP L 270 P 50 TOP W 270 D 50	524
1	MOC2261K	PENSILE RIBALTA ANTA LEGNO E VANO A GIORNO DX L 180 WALL UNIT WITH WOODEN DROP-DOWN DOOR WITH DECORATION, AND OPEN COMPARTMENT RH W 180	1.318
1	MOC2202K	PENSILE VASISTAS ANTA LEGNO E VANO A GIORNO SX L 180 WALL UNIT WITH WOODEN DROP-DOWN DOOR WITH DECORATION AND OPEN COMPARTMENT LH W 180	1.318
PREZZO TOTALE TOTAL PRICE			5.975

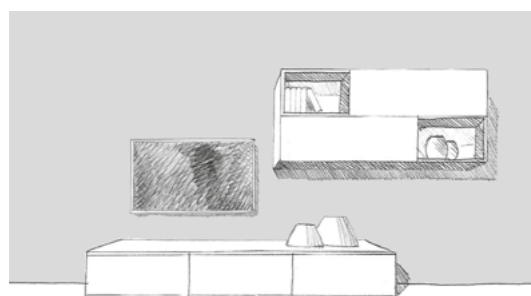

L. W. 340
P. D. 50

DECOR NOTTE E GIORNO

DECOR NIGHT AND DAY

CARATTERISTICHE TECNICHE TECHNICAL CHARACTERISTICS	60
LETTI BEDS	67
ARMADI WARDROBES	68
COMODINO, COMÒ, SETTIMINO E SPECCHIERE BEDSIDE TABLES, CHEST OF DRAWERS, 7-DRAWER CHEST AND MIRRORS	70
VETRINE E CREDENZE DISPLAY UNITS AND SIDEBOARDS	71
TAVOLI E SEDIE TABLES AND CHAIRS	72
PORTA TV E MADIE DECOR DECOR TV UNIT AND CUPBOARDS	73
COMPOSIZIONI A CATALOGO CATALOGUE COMPOSITIONS	74

DECOR NOTTE - NIGHT

CARATTERISTICHE TECNICHE TECHNICAL CHARACTERISTICS

NEW

CHLOE

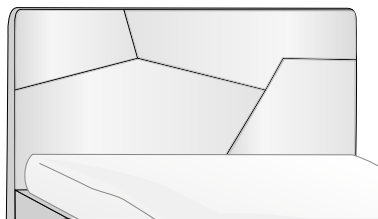

PANNELLO IMBOTTITO NON SFODERABILE
UPHOLSTERED PANEL WITHOUT REMOVABLE COVER

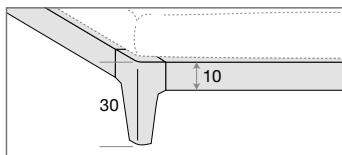

GIROLETTO LEGNO
WOODEN BED SURROUND

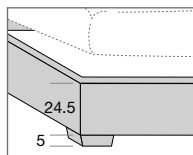

GIROLETTO CONTENITORE
STORAGE BED SURROUND

LETTO CON PANNELLO TESTIERA IMBOTTITO

TESTIERA PANNELLO DI MULTISTRATI PIOPPPO SP. 3 E BORDATO NOCE O FRASSINO. ELEMENTO IMBOTTITO RIVESTITO IN TESSUTI DA CAMPIONARIO.

GIROLETTO E PIEDI GIROLETTO LEGNO IN PANNELLO LISTELLARE RIVESTITO NOCE O FRASSINO
PIEDE IN MASSELLO DI NOCE TOULIPIER O FRASSINO

BED WITH UPHOLSTERED HEADBOARD PANEL

HEADBOARD POPLAR MULTILAYER PANEL TH. 3 AND EDGED IN WALNUT OR ASH. UPHOLSTERED ELEMENT UPHOLSTERED IN SAMPLE FABRICS.

BED SURROUND AND FEET WOODEN BED BED IN COATED STRIP PANEL WALNUT OR ASH
SOLID WALNUT FOOT TOULIPIER OR ASH

DECOR

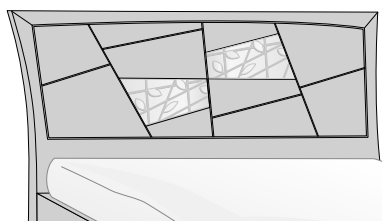

PANNELLO DECORATO
DECORATED PANEL

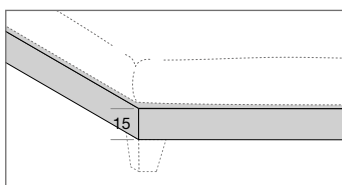

GIROLETTO LEGNO
WOODEN BED SURROUND

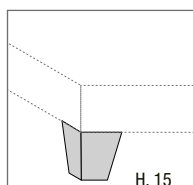

PIEDE LEGNO MASSELLO
SOLID WOOD FOOT

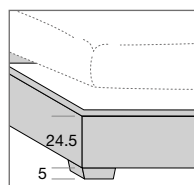

GIROLETTO CONTENITORE
STORAGE BED SURROUND

LETTO CON PANNELLO LEGNO DECORATO

PROFILO TESTIERA MASSELLO DI TOULIPIER O FRASSINO SPAZZOLATO SP. CM. 8, VERNICIATO O LACCATO A PORO APERTO.

PANNELLO DI LISTELLARE IMPIALLACCIATO IN NOCE TANGANICA O FRASSINO SPAZZOLATO SPESSORE CM.2.5 E PANNELLO DECORATIVO TRAFORATO IN PANNELLO DI MULTISTRATI NOCE O FRASSINO SPAZZOLATO, VERNICIATO O LACCATO A PORO APERTO.

GIROLETTO E PIEDI IMPIALLACCIATO NOCE O FRASSINO SPAZZOLATO E PIEDI IN LEGNO MASSELLO DI TOULIPIER O FRASSINO SPAZZOLATO SP. CM 4, VERNICIATO O LACCATO A PORO APERTO.

TRAVERSO REGGIRETE MASSELLO SP. CM. 4, POSIZIONAMENTO CENTRALE CON PIEDINO REGOLABILE IN PLASTICA

BED WITH DECORATED WOODEN PANEL

HEADBOARD PROFILE TOULIPIER SOLID WOOD OR BRUSHED SOLID ASHWOOD TH. CM. 8, PAINTED OR OPEN PORE LACQUERED.

PANEL BLOCKBOARD VENEERED IN TANGANICA WALNUT OR BRUSHED ASHWOOD TH. CM.2,5 AND PERFORATED DECORATIVE PANEL IN WALNUT MULTILAYER OR BRUSHED ASHWOOD, PAINTED OR OPEN PORE LACQUERED.

BED SURROUND AND FEET VENEERED IN WALNUT OR BRUSHED ASHWOOD AND FEET IN TOULIPIER SOLID WOOD OR BRUSHED ASHWOOD TH. CM 4, PAINTED OR OPEN PORE LACQUERED.

CROSS PIECE FOR BED BASE UNIT WITH SUPPORT SOLID TH. CM. 4, CENTRAL POSITIONING WITH PLASTIC ADJUSTABLE FOOT

MONDRIAN

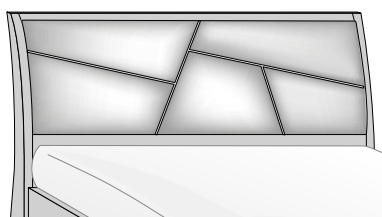

PANNELLO IMBOTTITO NON SFODERABILE
UPHOLSTERED PANEL WITHOUT REMOVABLE COVER

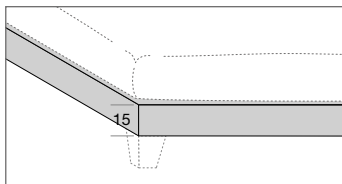

GIROLETTO LEGNO
WOODEN BED SURROUND

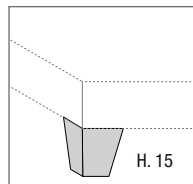

PIEDE LEGNO MASSELLO
SOLID WOOD FOOT

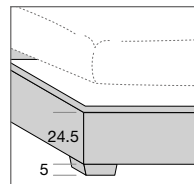

GIROLETTO CONTENITORE
STORAGE BED SURROUND

LETTO CON PANNELLO TESTIERA IMBOTTITO

TESTIERA LEGNO MASSELLO DI TOULIPIER O FRASSINO SPAZZOLATO SP. CM. 6 CON PANNELLO IN LISTELLARE IMPIALLACCIATO IN NOCE TANGANICA O FRASSINO SPAZZOLATO SP. CM. 2.5 VERNICIATO O LACCATO A PORO APERTO.

PANNELLO IMBOTTITO PANNELLO DI MULTISTRATO PIOPPPO DA CM 0.8 DI STRUTTURA E CM 0.8 DI GOMMAPIUMA, RIVESTIMENTO COME DA CAMPIONARIO.

GIROLETTO IN LISTELLARE IMPIALLACCIATO NOCE O FRASSINO SPAZZOLATO SP. CM. 3, PIEDE LEGNO IN MASSELLO DI TOULIPIER O FRASSINO SPAZZOLATO SP. CM. 4, VERNICIATO O LACCATO A PORO APERTO.

TRAVERSO REGGIRETE MASSELLO SP. CM. 4, POSIZIONAMENTO CENTRALE CON PIEDINO REGOLABILE IN PLASTICA

BED WITH UPHOLSTERED HEADBOARD PANEL

WOODEN HEADBOARD TOULIPIER SOLID WOOD OR BRUSHED SOLID ASHWOOD TH. CM. 6 WITH BLOCKBOARD PANEL VENEERED IN TANGANICA WALNUT OR BRUSHED ASHWOOD TH. CM. 2.5 PAINTED OR OPEN PORE LACQUERED.

UPHOLSTERED PANEL PANNELLO DI POPLAR MULTILAYER CM 0.8 STRUTTURA AND CM 0.8 FOAM RUBBER, COVERED IN OUR RANGE FINISHES.

BED SURROUND IN BLOCKBOARD VENEERED IN WALNUT OR BRUSHED ASHWOOD TH. CM. 3, WOODEN FOOT IN TOULIPIER SOLID WOOD OR BRUSHED SOLID ASHWOOD TH. CM. 4, PAINTED OR OPEN PORE LACQUERED.

CROSS PIECE FOR BED BASE UNIT WITH SUPPORT SOLID TH. CM. 4, CENTRAL POSITIONING WITH PLASTIC ADJUSTABLE FOOT

ODETTE

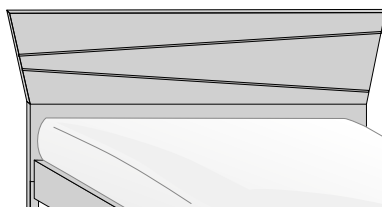

TESTIERA LETTO LEGNO
BED WITH WOODEN HEADBOARD

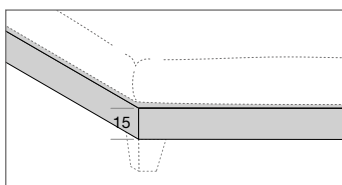

GIROLETTO LEGNO
WOODEN BED SURROUND

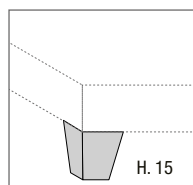

PIEDE LEGNO MASSELLO
SOLID WOOD FOOT

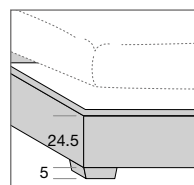

GIROLETTO CONTENITORE
STORAGE BED SURROUND

LETTO CON TESTIERA IN LEGNO INCLINATO

PROFILO TESTIERA LEGNO IN PANNELLO LISTELLARE IMPIALLACCIATO NOCE TANGANICA O FRASSINO SPAZZOLATO SP. CM. 2.5 VERNICIATO O LACCATO A PORO APERTO.

PANNELLO DECORATIVO PANNELLO IN MDF IMPIALLACCIATO IN NOCE O FRASSINO SPAZZOLATO SP. CM. 0.4, VERNICIATO O LACCATO A PORO APERTO.

GIROLETTO LISTELLARE IMPIALLACCIATO NOCE O FRASSINO SPAZZOLATO SP. CM. 3 E PIEDE LEGNO IN MASSELLO DI TOULIPIER O FRASSINO SPAZZOLATO SP. CM. 4, VERNICIATO O LACCATO A PORO APERTO.

TRAVERSO REGGIRETE MASSELLO SP. CM. 4, POSIZIONAMENTO CENTRALE CON PIEDINO REGOLABILE IN PLASTICA

BED WITH INCLINED WOODEN HEADBOARD

HEADBOARD PROFILE BLOCKBOARD WOOD PANEL VENEERED IN TANGANICA WALNUT OR BRUSHED ASHWOOD TH. CM. 2.5 PAINTED OR OPEN PORE LACQUERED.

DECORATIVE PANEL PANNELLO IN MDF VENEERED IN WALNUT OR BRUSHED ASHWOOD TH. CM. 0.4, PAINTED OR OPEN PORE LACQUERED.

BED SURROUND BLOCKBOARD VENEERED IN WALNUT OR BRUSHED ASHWOOD TH. CM. 3 AND WOODEN FOOT IN TOULIPIER SOLID WOOD OR BRUSHED SOLID ASHWOOD TH. CM. 4, PAINTED OR OPEN PORE LACQUERED.

CROSS PIECE FOR BED BASE UNIT WITH SUPPORT SOLID TH. CM. 4, CENTRAL POSITIONING WITH PLASTIC ADJUSTABLE FOOT

CARATTERISTICHE TECNICHE
TECHNICAL CHARACTERISTICS

ARMADIO ANTE SCORREVOLI

CAPPELLO, FONDO E FIANCO DIVISORIO	PANNELLO DI PARTICELLE DI LEGNO RIVESTITO SU 2 LATI IN DECORATIVO OLMO SBIANCATO SP. 2,5 CM
FIANCO ESTERNO	PANNELLO IN LEGNO CON TELAIO IN ABETE DI SP. CM. 3 IMPIALLACCIATO ESTERNAMENTE IN NOCE TANGANICA VERNICIATO ED INTERNAMENTE IN DECORATIVO.
RIPIANO	PANNELLO DI PARTICELLE DI LEGNO RIVESTITO SU 2 LATI IN DECORATIVO OLMO SBIANCATO SP. 2,5 CM E BORDO FRONTALE SP. 3,6 CM
SCHIENALE	PANNELLO DI MDF IMPIALLACCIATO IN DECORATIVO SP. CM.0.8.
VERSIONI	2 O 3 ANTE SCORREVOLI.

WARDROBE WITH SLIDING DOORS

TOP, BOTTOM AND PARTITION SIDE PANEL	PANEL OF WOOD PARTICLES VENEERED 2 SIDES IN DECORATIVE "OLMO SBIANCATO" TH. 2.5 CM
OUTSIDE SIDE PANEL	WOOD PANEL WITH FIR FRAME TH. CM. 3, OUTSIDE VENEERED IN PAINTED TANGANICA WALNUT AND INSIDE IN DECORATIVE.
SHELF	PANEL OF WOOD PARTICLES COVERED ON 2 SIDES IN DECORATIVE 'OLMO SBIANCATO' TH. 2.5 CM AND FRONT EDGE TH. 3.6 CM
BACK PANEL	DECORATIVE VENEERED MDF PANEL TH. CM.0.8.
VERSIONS	2 OR 3 SLIDING DOORS.

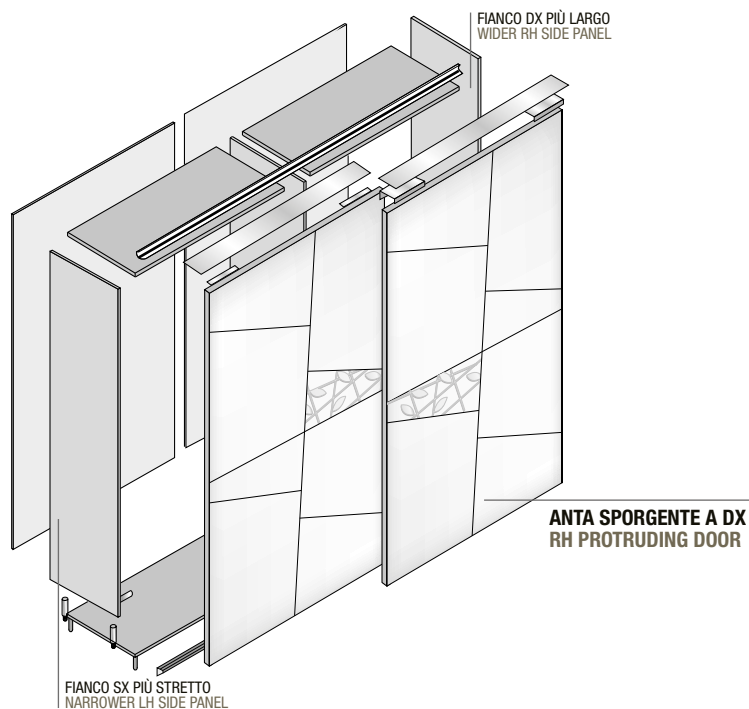

ANTE SCORREVOLI

ANTE	PANNELLO IN LEGNO CON TELAIO IN ABETE E MULTISTRATI PIOPPO CM 2.8 CON APPLICATI ELEMENTI DECORATIVI IN MDF IMPIALLACCIATO NOCE NAZIONALE O FRASSINO SPAZZOLATO, VERNICIATO O LACCATO A PORO APERTO. DECORO LEGNO TRAFORATO.
APERTURA	MANIGLIA LATERALE IN ZAMA VERNICIATO NICHEL LUCIDO
CASSETTIERA 3 CASSETTI (OPTIONAL)	FONDO E FIANCHI IN PANNELLO DECORATIVO SP. CM. 1.8, FRONTALE E STRUTTURA CASSETTI IN PANNELLO DI PARTICELLE DI LEGNO, FRONTALE CASSETTO IN PANNELLO DECORATIVO DI SP. CM. 1.8. I CASSETTI SCORRONO SU GUIDE A SCOMPARSA AD ESTRAZIONE PARZIALE. RIPIANO COPRI CASSETTIERA IN PANNELLO DI PARTICELLE DI LEGNO IMPIALLACCIATO IN DECORATIVO SP. CM.4.
SLIDING DOORS DOORS	WOOD PANEL WITH FIR FRAME AND POPLAR MULTILAYER CM 2.8 WITH APPLIED MDF DECORATIVE ELEMENTS VENEERED IN ITALIAN WALNUT OR BRUSHED ASHWOOD, PAINTED OR OPEN PORE LACQUERED. PERFORATED WOODEN DECORATION
OPENING	LATERAL HANDLE IN ZAMAK PAINTED POLISHED NICKEL
DRAWER UNIT WITH 3 DRAWERS (OPTIONAL)	BOTTOM AND SIDE IN DECORATIVE PANEL TH. CM. 1.8, DRAWER STRUCTURE AND FRONT IN WOOD PARTICLE BOARD PANEL, DRAWER FRONT IN DECORATIVE PANEL TH. CM. 1.8. DRAWERS RUN ON PARTIAL EXTRACTION CONCEALED GUIDES. DRAWER UNIT SHELF IN WOOD PARTICLE BOARD PANEL VENEERED IN DECORATIVE TH. CM.4.

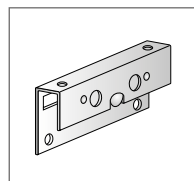

PATTINO SUPERIORE PER ANTA INTERNA
TOP RUNNER FOR INTERNAL DOOR

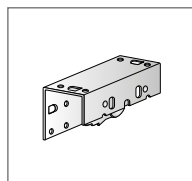

CARRELLO SUPERIORE ANTA
DOOR TOP RUNNER

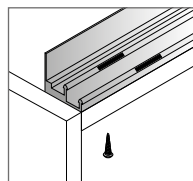

BINARIO SUPERIORE
TOP TRACK

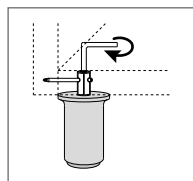

PIEDE REGOLATORE
ADJUSTABLE FOOT

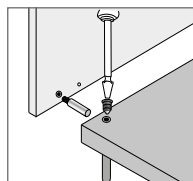

MONTAGGIO PIEDE REGOLATORE
ADJUSTABLE FOOT ASSEMBLY

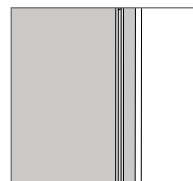

LAMPADA LED (OPTIONAL)
LED LAMP (OPTIONAL)

**VANI INTERNI
INTERNAL COMPARTMENT**

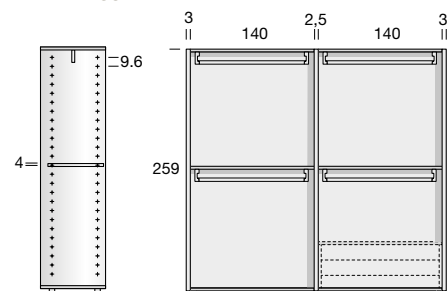

2 ANTE SCORREVOLI 2 SLIDING DOORS

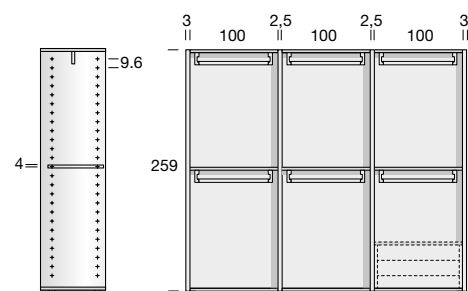

3 ANTE SCORREVOLI 3 SLIDING DOORS

**REGOLAZIONE ANTE PRIMA DEL MONTAGGIO
DOOR ADJUSTMENT BEFORE ASSEMBLY**

PRIMA DI PROCEDERE AL MONTAGGIO, BISOGNA REGOLARE LA TENSIONE DELLE ANTE POSIZIONANDOLE OBBLIGATORIAMENTE IN ORIZZONTALE E UTILIZZANDO UN CACCIAVITE O UN PUNTERUOLO.
BEFORE ASSEMBLING REGULATE DOOR TENSION BY PLACING THEM HORIZONTALLY AND USING THE SPECIAL SPANNER PROVIDED.

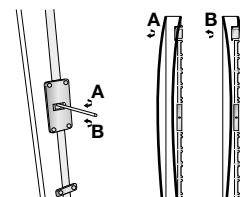

**MONTAGGIO ANTE SCORREVOLI
SLIDING DOOR ASSEMBLY**

PER POTER AGGANCIARE LE ANTE AL BINARIO SUPERIORE TRA IL SOFFITTO E L'ARMADIO CI DEVONO ESSERE ALMENO 3 CM.
LEAVE AT LEAST 3CM CLEARANCE SO THAT THE DOORS CAN BE ATTACHED TO THE UPPER RAIL BETWEEN THE CEILING AND WARDROBE.

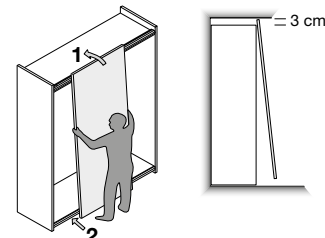

- 1 AGGANCIARE L'ANTA AL BINARIO SUPERIORE
FASTEN THE DOOR TO THE TOP TRACK
- 2 SPINGERE L'ANTA NEL BINARIO INFERIORE
PUSH THE DOOR IN THE LOW TRACK

**SMONTAGGIO ANTE SCORREVOLI
REMOVAL SLIDING DOORS**

PER SBLOCCARE LE ANTE DAL SISTEMA DI BLOCCAGGIO DI SICUREZZA È NECESSARIO AVVITARE IL GRANO (1), LA LINGUETTA (2) SI SPOSTA AUTOMATICAMENTE E SARÀ POSSIBILE SGANCIARE LE ANTE.
TO RELEASE THE DOORS FROM THE SAFETY LOCKING SYSTEM YOU NEED TO TIGHTEN THE SPECIAL SCREW(1), THE TAB (2) AUTOMATICALLY MOVES AND THE DOORS CAN BE RELEASED

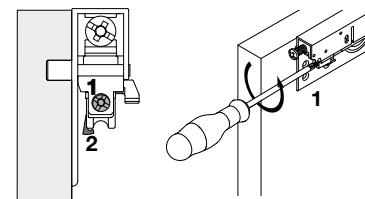

DECOR NOTTE - NIGHT

CARATTERISTICHE TECNICHE TECHNICAL CHARACTERISTICS

COMODINO, SETTIMINO E COMÒ "DECOR"

TOP	PANNELLO DI LISTELLARE IMPIALLACCIATO NOCE TANGANICA O FRASSINO SPAZZOLATO SP. CM. 1.5, VERNICIATO O LACCATO A PORO APERTO.
FONDO	PANNELLO DI MULTISTRATO PIOPPO DI SP. CM.1.8.
ZOCCOLO LEGNO	PANNELLO DI LISTELLARE IMPIALLACCIATO IN NOCE O FRASSINO SPAZZOLATO SP. CM. 3, VERNICIATO O LACCATO A PORO APERTO.
FIANCO	PANNELLO SCATOLATO CURVATO IMPIALLACCIATO ESTERNAMENTE IN NOCE NAZIONALE O FRASSINO SPAZZOLATO ED INTERNAMENTE IN PIOPPO DI SP. CM. 7.5, VERNICIATO O LACCATO A PORO APERTO.
SCHIENALE	PANNELLO DI MULTISTRATO SP. CM. 0.8 VERNICIATO O LACCATO A PORO APERTO.
GUIDE CASSETTO	AMMORTIZZATE REGOLABILI IN ALTEZZA.
APERTURE	PUSH PULL.

"DECOR" BEDSIDE TABLE, 7-DRAWER CHEST AND CHEST OF DRAWER

TOP	BLOCKBOARD PANEL VENEERED TANGANICA WALNUT OR BRUSHED ASHWOOD TH. CM. 1.5, PAINTED OR OPEN PORE LACQUERED.
BOTTOM PANEL	POPLAR MULTILAYER PANEL TH. CM.1.8.
WOODEN PLINTH	BLOCKBOARD PANEL VENEERED IN WALNUT OR BRUSHED ASHWOOD TH. CM. 3, PAINTED OR OPEN PORE LACQUERED.
SIDE PANEL	CURVED PANEL VENEERED ON THE OUTSIDE IN ITALIAN WALNUT OR BRUSHED ASHWOOD AND INSIDE IN POPLAR TH. CM. 7.5, PAINTED OR OPEN PORE LACQUERED.
BACK PANEL	POPLAR MULTILAYER PANEL TH. CM. 0.8 PAINTED OR OPEN PORE LACQUERED.
DRAWER GUIDES	HEIGHT ADJUSTABLE SOFT-CLOSE GUIDES
OPENINGS	PUSH PULL.

COMODINO 2 CASSETTI BEDSIDE TABLE WITH 2 DRAWERS

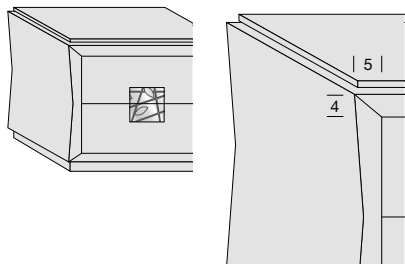

**FIANCO SAGOMATO
APERTURA PUSH-PULL**
SHAPED SIDE PANEL
PUSH-PULL OPENING

CORNICE COMODINO
FRAME FOR BEDSIDE TABLE

SETTIMINO 6 CASSETTI 6-DRAWER CHEST

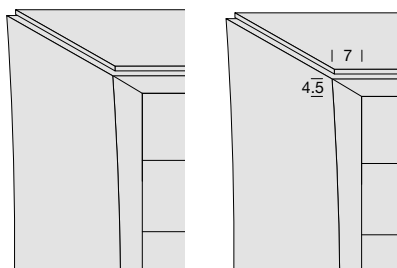

**FIANCO SAGOMATO
APERTURA PUSH-PULL**
SHAPED SIDE PANEL
PUSH-PULL OPENING

CORNICE SETTIMINO
FRAME FOR 7-DRAWER CHEST

COMÒ 4 CASSETTI CHEST OF DRAWERS WITH 4 DRAWERS

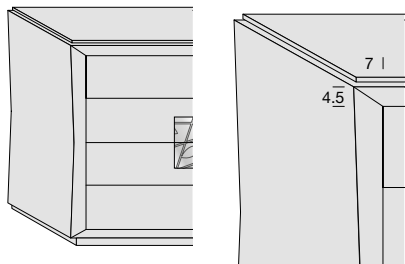

**FIANCO SAGOMATO
APERTURA PUSH-PULL**
SHAPED SIDE PANEL
PUSH-PULL OPENING

CORNICE SETTIMINO
FRAME FOR 7-DRAWER CHEST

COMODINO, SETTIMINO E COMÒ

FRONTALE CASSETTO	PANNELLO DI LISTELLARE IMPIALLACCIATO NOCE O FRASSINO SPAZZOLATO SP. CM.2.5, VERNICIATO O LACCATO A PORO APERTO. DECORO LEGNO TRAFORATO
STRUTTURA CASSETTO	PANNELLO DI MULTISTRATO BETTULLA SPESSORE CM.1,5 CON INCASTRI A CODA DI RONDINE, VERNICIATO IN FINITURA TINTA ACACIA.
APERTURA	PUSH-PULL CON GUIDE REGOLABILI IN ALTEZZA

BEDSIDE TABLE, 6-DRAWER CHEST AND CHEST OF DRAWERS

DRAWER FRONT	BLOCKBOARD PANEL VENEERED IN WALNUT OR BRUSHED ASHWOOD TH. CM.2.5, PAINTED OR OPEN PORE LACQUERED. PERFORATED WOODEN DECORATION.
DRAWER STRUCTURE	BIRCH MULTILAYER PANEL TH. CM.1,5 WITH DOVETAIL JOINTS, PAINTED IN ACACIA STAINED FINISH.
OPENING	PUSH-PULL WITH HEIGHT ADJUSTABLE GUIDES

DECOR

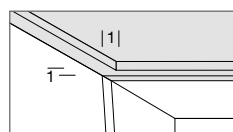

PARTICOLARE TOP RIENTRANTE
DETAIL OF RECESSED TOP

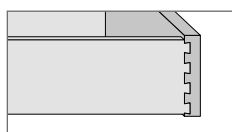

INCASTRI A CODA DI RONDINE
DOVETAIL JOINTS

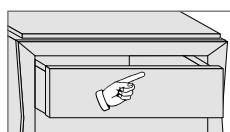

CHIUSURA CASSETTI PUSH-PULL
DRAWERS WITH PUSH-PULL CLOSURE

CARATTERISTICHE TECNICHE
TECHNICAL CHARACTERISTICS

COMODINO, SETTIMINO E COMÒ "MONDRIAN"

TOP	PANNELLO DI LISTELLARE IMPIALLACCIATO IN NOCE O FRASSINO SPAZZOLATO SP. CM. 4.3 VERNICIATO O LACCATO A PORO APERTO.
FONDO	PANNELLO MULTISTRATO PIOPO DI SP. CM. 1.8.
FIANCO	PANNELLO SCATOLATO CURVATO IMPIALLACCIATO ESTERNAMENTE IN NOCE NAZIONALE O FRASSINO SPAZZOLATO ED INTERNAMENTE IN PIOPO DI SPESSORE CM.9, VERNICIATO O LACCATO A PORO APERTO.
SCHIENALE	PANNELLO MULTISTRATO SP. CM. 0.8 VERNICIATO O LACCATO A PORO APERTO.
GUIDE CASSETTO	AMMORTIZZATE REGOLABILI IN ALTEZZA.

BEDSIDE TABLE, 6-DRAWER CHEST AND CHEST OF DRAWER "MONDRIAN"

TOP	BLOCKBOARD PANEL VENEERED IN WALNUT OR BRUSHED ASHWOOD TH. CM. 4.3 PAINTED OR OPEN PORE LACQUERED.
BOTTOM PANEL	POPLAR MULTILAYER PANEL TH. CM. 1.8.
SIDE PANEL	CURVED PANEL VENEERED ON THE OUTSIDE IN ITALIAN WALNUT OR BRUSHED ASHWOOD AND INSIDE IN POPLAR TH. CM.9, PAINTED OR OPEN PORE LACQUERED.
BACK PANEL	MULTILAYER PANEL TH. CM. 0.8 PAINTED OR OPEN PORE LACQUERED.
DRAWER GUIDES	HEIGHT ADJUSTABLE SOFT-CLOSE GUIDES

**COMODINO 2 CASSETTI
BEDSIDE TABLE WITH 2 DRAWERS**

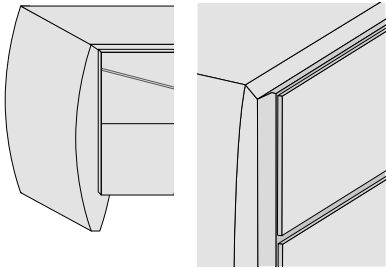

FIANCO BOMBATO
CURVED SIDE PANEL

APERTURA MANUALE NEL PRIMO CASS.
FIRST DRAWER WITH MANUAL OPENING

**SETTIMINO
6-DRAWER CHEST**

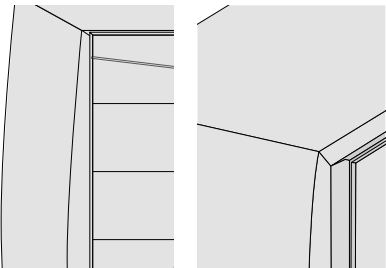

FIANCO BOMBATO
CURVED SIDE PANEL

APERTURA MANUALE NEL PRIMO CASS.
FIRST DRAWER WITH MANUAL OPENING

**COMÒ 3 CASSETTI
CHEST OF DRAWERS WITH 3 DRAWERS**

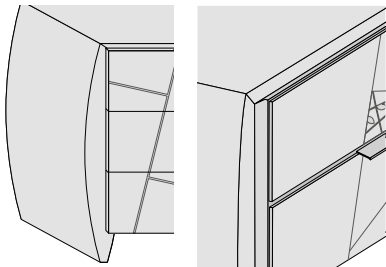

FIANCO BOMBATO
CURVED SIDE PANEL

APERTURA MANUALE NEL PRIMO CASS.
FIRST DRAWER WITH MANUAL OPENING

COMODINO, SETTIMINO E COMÒ

FRONTALE CASSETTO	PANNELLO DI LISTELLARE IMPIALLACCIATO IN NOCE O FRASSINO SPAZZOLATO SP. CM. 2.5 VERNICIATO O LACCATO A PORO APERTO.
STRUTTURA CASSETTO	PANNELLO DI MULTISTRATO BETULLA SP. CM. 1.5 CON INCASTRI A CODA DI RONDINE, VERNICIATO IN FINITURA TINTA ACACIA.
MANIGLIA	APERTURA MANUALE NEL PRIMO CASSETTO E MANIGLIA "MONDRIAN" IN TINTA CON IL MOBILE NEI SUCCESSIVI CASSETTI.

BEDSIDE TABLE, 6-DRAWER CHEST AND CHEST OF DRAWERS

DRAWER FRONT	BLOCKBOARD PANEL VENEERED IN WALNUT OR BRUSHED ASHWOOD TH. CM. 2.5 PAINTED OR OPEN PORE LACQUERED.
DRAWER STRUCTURE	BIRCH MULTILAYER PANEL TH. CM. 1.5 WITH DOVETAIL JOINTS, PAINTED IN ACACIA STAINED FINISH.
HANDLE	FIRST DRAWER WITH MANUAL OPENING AND "MONDRIAN" HANDLE IN THE SAME COLOUR AS THE UNIT AND IN THE FOLLOWING DRAWERS.

MONDRIAN

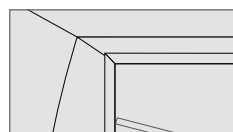

PARTICOLARE TOP A FOLDING
FOLDING TOP DETAIL

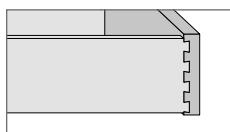

INCASTRI A CODA DI RONDINE
DOVETAIL JOINTS

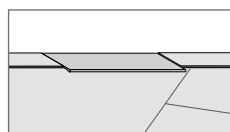

MANIGLIA MONDRIAN
MONDRIAN HANDLE

DECOR NOTTE - NIGHT

CARATTERISTICHE TECNICHE TECHNICAL CHARACTERISTICS

SPECCHIERE MIRRORS

DECOR

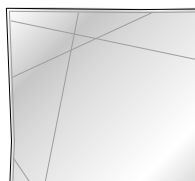

SPECCHIERA

SPECCHIO SP. 0.5 CM SAGOMATO BISELLATO FILO LUCIDO E INCISIONI DECORATIVE.
SUPPORTO PANNELLO DECORATIVO SP. CM. 1.9

MIRROR

MIRROR TH. 0.5 CM GLOSSY FLUSH SHAPED, CHAMFERED AND DECORATIVE ENGRAVING
SUPPORT DECORATIVE PANEL TH. CM. 1.9

ELIOS

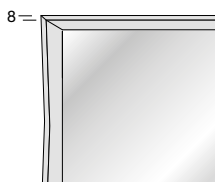

SPECCHIERA

TELAIO MASSELLO TOULUPIER O FRASSINO SPAZZOLATO SP. CM. 3 CM VERNICIATO O LACCATO A PORO APERTO.
SUPPORTO SP. CM. 0.4.

MIRROR

FRAME TOULUPIER SOLID WOOD OR SOLID ASHWOOD TH. CM. 3 CM PAINTED OR OPEN PORE LACQUERED.
SUPPORT TH. CM. 0.4.

SEDIE FUSTO

MASSELLO DI FAGGIO, VERNICIATO O LACCATO.

CHAIRS CARCASE

LACQUERED OR PAINTED BEECH SOLID WOOD.

DECOR

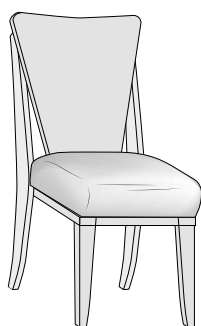

SEDIA

IMBOTTITURA SEDILE IN GOMMAPIUMA E RIVESTIMENTO COME DA CAMPIONARIO.
SCHIENALE PANNELLO DI MULTISTRATO IMPIALLACCIATO FRASSINO A PORO APERTO O NOCE TANGANIKAI

CHAIR

PADDING SEAT IN FOAM RUBBER AND COVERED IN OUR RANGE FINISHES.
BACK PANEL MULTILAYER PANEL VENEERED IN OPEN PORE ASHWOOD OR TANGANIKAI WALNUT

ELLE

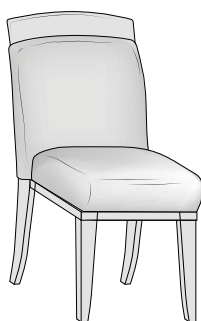

SEDIA

IMBOTTITURA SEDILE E SCHIENALE IN GOMMAPIUMA E RIVESTIMENTO COME DA CAMPIONARIO
SCHIENALE SUPERIORE MASSELLO IN FRASSINO SPAZZOLATO A PORO APERTO O FAGGIO

CHAIR

PADDING BACK PANEL AND SEAT IN FOAM RUBBER AND COVERED IN OUR RANGE FINISHES.
TOP BACK PANEL OPEN PORE BRUSHED SOLID ASHWOOD OR BEECH

CARATTERISTICHE TECNICHE TECHNICAL CHARACTERISTICS

CREDENZE E VETRINE

STRUTTURA INTERNA	PANNELLO DI MULTISTRATO PIOPPO SPESSORE CM. 1.8, VERNICIATO O LACCATO A PORO APERTO.
RIPIANI	VETRO FILO LUCIDO SP. CM. 0.8.
ZOCCOLO LEGNO	PANNELLO DI LISTELLARE IMPIALLACCIATO IN NOCE O FRASSINO SPAZZOLATO SP. CM. 3 VERNICIATO O LACCATO A PORO APERTO.
VERSIONI CREDENZE	2 ANTE E 2 ANTE E 3 CASSETTI.
VERSIONI VETRINE	1 ANTA VETRO; 2 ANTE VETRO; 1 ANTA VETRO CON E PANNELLO DECORO LEGNO; 2 ANTE VETRO CON PANNELLO DECORO LEGNO.

SIDEBOARDS AND DISPLAY UNITS

INTERNAL STRUCTURE	POPLAR MULTILAYER PANEL TH. CM. 1.8, PAINTED OR OPEN PORE LACQUERED.
SHELVES	FLUSH GLOSSY GLASS TH. CM. 0.8.
WOODEN PLINTH	BLOCKBOARD PANEL VENEERED IN WALNUT OR BRUSHED ASHWOOD TH. CM. 3 PAINTED OR OPEN PORE LACQUERED.
SIDEBOARD VERSIONS	2 DOORS AND 2 DOORS AND 3 DRAWERS.
DISPLAY UNIT VERSIONS	1 GLASS DOOR; 2 GLASS DOORS; 1 GLASS DOOR AND WOODEN DECORATION PANEL; 2 GLASS DOORS WITH WOODEN DECORATION PANEL.

DECOR

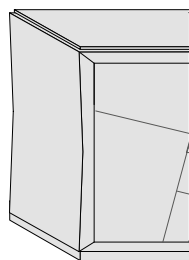

FIANCO SAGOMATO
SHAPED SIDE PANEL

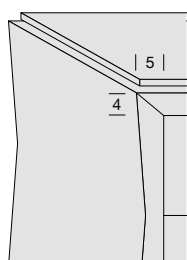

CORNICE CREDENZA
FRAME FOR SIDEBOARD

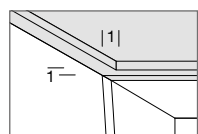

PARTICOLARE TOP RIENTRANTE
DETAIL OF RECESSED TOP

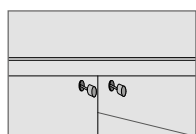

CHIUSURA ANTE CON CHIAVE
DOORS CLOSURE WITH KEY

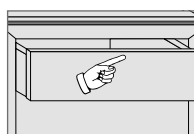

CHIUSURA CASSETTI PUSH-PULL
DRAWERS WITH PUSH-PULL CLOSURE

CREDENZA

TOP	PANNELLO DI LISTELLARE IMPIALLACCIATO NOCE O FRASSINO SPAZZOLATO SP. CM. 1.5, VERNICIATO O LACCATO A PORO APERTO.
FIANCO	PANNELLO SCATOLATO CURVATO IMPIALLACCIATO ESTERNAMENTE NOCE O FRASSINO SPAZZOLATO ED INTERNAMENTE IN NOCE TANGANICA SP. CM. 7.5, VERNICIATO O LACCATO A PORO APERTO.
SCHIENALE	PANNELLO DI MULTISTRATO PIOPPO SP. CM. 0.8 VERNICIATO O LACCATO.
ANTA	LISTELLARE IMPIALLACCIATO IN NOCE TANGANICA O FRASSINO SPAZZOLATO SP. CM. 2.5 E PANNELLO DECORATIVO IN MDF IMPIALLACCIATO IN NOCE O FRASSINO SP. CM. 0.4, VERNICIATO O LACCATO A PORO APERTO.
APERTURA	CHIAVE IN FINITURA NICHEL LUCIDO O PUSH-PULL E PUSH-PULL PER I CASSETTI.

SIDEBOARD

TOP	BLOCKBOARD PANEL VENEERED IN WALNUT OR BRUSHED ASHWOOD TH. CM. 1.5, PAINTED OR OPEN PORE LACQUERED.
SIDE PANEL	CURVED PANEL VENEERED ON THE OUTSIDE IN WALNUT OR BRUSHED ASHWOOD AND INSIDE IN TANGANICA WALNUT TH. CM. 7.5, PAINTED OR OPEN PORE LACQUERED.
BACK PANEL	POPLAR MULTILAYER PANEL TH. CM. 0.8 PAINTED OR LAQUERED.
DOOR	BLOCKBOARD VENEERED IN TANGANICA WALNUT OR BRUSHED ASHWOOD TH. CM. 2.5 AND MDF DECORATIVE PANEL VENEERED IN WALNUT OR ASHWOOD TH. CM. 0.4, PAINTED OR OPEN PORE LACQUERED.
OPENING	KEY IN GLOSSY NICKEL FINISH OR PUSH-PULL AND PUSH-PULL FOR DRAWERS.

MONDRIAN

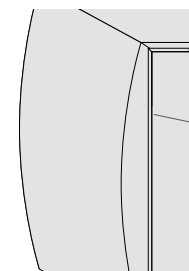

FIANCO BOMBATO
CURVED SIDE PANEL

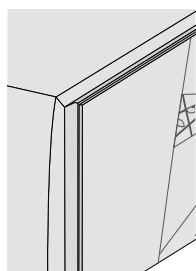

APERTURA MANUALE
MANUAL OPENING

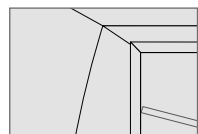

PARTICOLARE TOP A FOLDING
FOLDING TOP DETAIL

CREDENZA

TOP	PANNELLO DI LISTELLARE IMPIALLACCIATO IN NOCE O FRASSINO SPAZZOLATO SP. CM. 4.3, VERNICIATO O LACCATO A PORO APERTO.
FIANCO	PANNELLO SCATOLATO CURVATO IMPIALLACCIATO ESTERNAMENTE IN NOCE O FRASSINO SPAZZOLATO ED INTERNAMENTE IN NOCE TANGANICA DI SP. CM. .9, VERNICIATO O LACCATO A PORO APERTO.
SCHIENALE	PANNELLO DI MULTISTRATO PIOPPO SP. CM. 0.8, VERNICIATO O LACCATO.
ANTA	LISTELLARE IMPIALLACCIATO NOCE TANGANICA O FRASSINO SPAZZOLATO SP. CM. 2.5 E PANNELLO DECORATIVO DI MDF IMPIALLACCIATO IN NOCE O FRASSINO SP. CM. 0.4, VERNICIATO O LACCATO A PORO APERTO.
MANIGLIA	APERTURA MANUALE.

SIDEBOARD

TOP	BLOCKBOARD PANEL VENEERED IN WALNUT OR BRUSHED ASHWOOD TH. CM. 4.3, PAINTED OR OPEN PORE LACQUERED.
SIDE PANEL	CURVED PANEL VENEERED ON THE OUTSIDE IN WALNUT OR BRUSHED ASHWOOD AND INSIDE IN TANGANICA WALNUT TH. CM. .9, PAINTED OR OPEN PORE LACQUERED.
BACK PANEL	POPLAR MULTILAYER PANEL TH. CM. 0.8, PAINTED OR LAQUERED.
DOOR	BLOCKBOARD VENEERED TANGANICA WALNUT OR BRUSHED ASHWOOD TH. CM. 2.5 AND MDF DECORATIVE PANEL, VENEERED IN WALNUT OR ASHWOOD TH. CM. 0.4, PAINTED OR OPEN PORE LACQUERED.
HANDLE	MANUAL OPENING.

DECOR WOOD

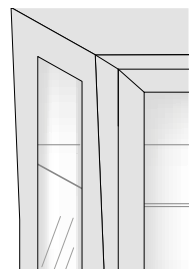

FIANCO SAGOMATO
SHAPED SIDE PANEL

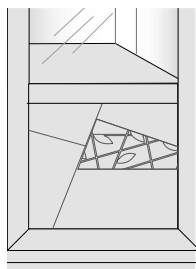

PANNELLO CON DECORO LEGNO
PANEL WITH WOODEN DECORATION

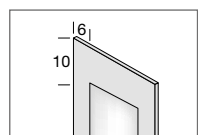

FIANCO CON VETRO
SIDE PANEL WITH GLASS

VETRINA

CAPPELLO	PANNELLO DI LISTELLARE IMPIALLACCIATO IN NOCE TANGANICA O FRASSINO SP. CM. 1.8, VERNICIATO O LACCATO.
TELAIO	FRONTALE VETRINA IN MASSELLO DI NOCE O FRASSINO SP. CM. 3.2, VERNICIATO O LACCATO A PORO APERTO.
FONDO	PANNELLO DI LISTELLARE IMPIALLACCIATO IN NOCE TANGANICA O FRASSINO SP. CM. 1.8
FIANCO	MASSELLO DI TOULIPIER O FRASSINO SAGOMATO SP. CM. 4, VERNICIATO O LACCATO A PORO APERTO. VETRO FLOAT SP. CM. 0.4.
SCHIENALE	PANNELLO DI MULTISTRATO IMPIALLACCIATO TANGANICA O FRASSINO SP. CM. 0.8, PROFILO SUPPORTO RIPIANI IN MASSELLO DI TOULIPIER SP. CM. 6, VERNICIATO O LACCATO.
ANTA	MASSELLO TOULIPIER O FRASSINO SP. CM. 2.7 E PANNELLO DECORATIVO IN MULTISTRATO IMPIALLACCIATO NOCE O FRASSINO SPAZZOLATO SP. CM. 0.5, VERNICIATO O LACCATO A PORO APERTO. VETRO FLOAT SP. CM. 0.4. PANNELLO PORTA MULTISTRATI NOCE O FRASSINO SPAZZOLATO CON DECORO PANNELLO MDF SP. CM. 0.4 IMPIALLACCIATO NOCE O FRASSINO VERNICIATO O VERNICIATO O LACCATO A PORO APERTO.
APERTURA	CHIAVE DI SERIE IN FINITURA NICHEL LUCIDO.

DISPLAY UNIT

TOP	BLOCKBOARD PANEL VENEERED IN TANGANICA WALNUT OR ASHWOOD TH. CM. 1.8, PAINTED OR LACQUERED.
FRAME	DISPLAY UNIT FRONT IN WALNUT SOLID WOOD OR SOLID ASHWOOD TH. CM. 3.2, PAINTED OR OPEN PORE LACQUERED.
BOTTOM PANEL	BLOCKBOARD PANEL VENEERED IN TANGANICA WALNUT OR ASHWOOD TH. CM. 1.8
SIDE PANEL	TOULIPIER SOLID WOOD OR SHAPED SOLID ASHWOOD TH. CM. 4, PAINTED OR OPEN PORE LACQUERED. FLOAT GLASS TH. CM. 0.4.
BACK PANEL	MULTILAYER VENEERED PANEL TANGANICA OR ASHWOOD TH. CM. 0.8, SHELF SUPPORT PROFILE IN TOULIPIER SOLID WOOD TH. CM. 6, PAINTED OR LACQUERED.
DOOR	TOULIPIER SOLID WOOD OR SOLID ASHWOOD TH. CM. 2.7 AND MULTILAYER DECORATIVE PANEL VENEERED IN WALNUT OR BRUSHED ASHWOOD TH. CM. 0.5, PAINTED OR OPEN PORE LACQUERED. FLOAT GLASS TH. CM. 0.4.
OPENING	MULTILAYER DOOR PANEL IN WALNUT OR BRUSHED ASHWOOD WITH MED DECORATIVE PANEL TH. CM. 0.4 VENEERED IN WALNUT OR ASHWOOD PAINTED OR PAINTED OR OPEN PORE LACQUERED.
OPENING	STANDARD KEY IN GLOSSY NICKEL FINISH.

DECOR GIORNO - DAY

CARATTERISTICHE TECNICHE TECHNICAL CHARACTERISTICS

TAVOLI E TAVOLINI

TABLES AND SMALL TABLES

DECOR

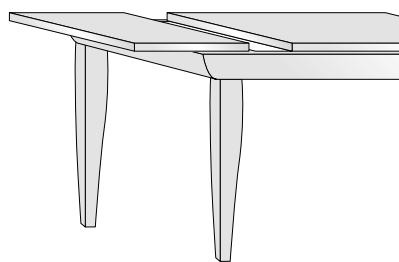

TAVOLO ALLUNGABILE:
IL PIANO SCORRE LATERALMENTE PER POTER INSERIRE L'ALLUNGA
EXTENDING TABLE
THE TOP SLIDES SIDEWAYS TO ACCOMMODATE THE EXTENSION.

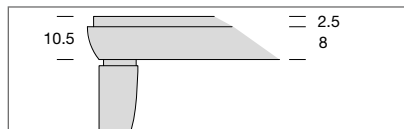

PROFILO TAVOLO
TABLE PROFILE

TAVOLO RETTANGOLARE E QUADRATO FISSO E ALLUNGABILE

PIANO	PANNELLO DI PARTICELLE DI LEGNO IMPIALLACCIATO IN NOCE O FRASSINO SPAZZOLATO, BORDATO IN MASSELLO DI TOULIPIER O FRASSINO SPAZZOLATO SP. CM. 2.6, VERNICIATO O LACCATO A PORO APERTO.
ALLUNGA	PANNELLO DI PARTICELLE DI LEGNO IMPIALLACCIATO IN NOCE O FRASSINO SPAZZOLATO, BORDATO IN MASSELLO DI TOULIPIER O FRASSINO SP. CM. 2.6, VERNICIATO O LACCATO A PORO APERTO.
STRUTTURA	MASSELLO DI TOULIPIER O FRASSINO SPAZZOLATO SP. CM. 3.4, VERNICIATO O LACCATO A PORO APERTO.
GAMBA	MASSELLO DI TOULIPIER O FRASSINO SPAZZOLATO SP. CM. 11, VERNICIATO O LACCATO A PORO APERTO.

SQUARE AND RECTANGULAR FIXED AND EXTENDABLE TABLE

TOP	WOOD PARTICLE BOARD PANEL VENEERED IN WALNUT OR BRUSHED ASHWOOD, EDGE IN TOULIPIER SOLID WOOD OR SOLID ASHWOOD TH. CM. 2.6, PAINTED OR OPEN PORE LACQUERED.
EXTENSION	WOOD PARTICLE BOARD PANEL VENEERED IN WALNUT OR BRUSHED ASHWOOD, EDGE IN TOULIPIER SOLID WOOD OR SOLID ASHWOOD TH. CM. 2.6, PAINTED OR OPEN PORE LACQUERED.
STRUCTURE	TOULIPIER SOLID WOOD OR BRUSHED SOLID ASHWOOD TH. CM. 3.4, PAINTED OR OPEN PORE LACQUERED.
LEG	TOULIPIER SOLID WOOD OR BRUSHED SOLID ASHWOOD TH. CM. 11, PAINTED OR OPEN PORE LACQUERED.

PIANO IN LEGNO FISSO FIXED WOODEN TOP

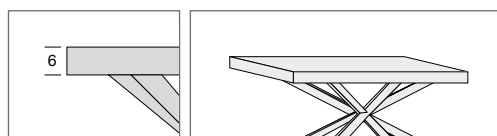

PROFILO PIANO LEGNO
WOODEN TOP PROFILE

PIANO RETTANGOLARE LEGNO FISSO
WOODEN RECTANGULAR FIXED TOP

PIANO IN LEGNO ALLUNGABILE EXTENSIBLE WOODEN TOP

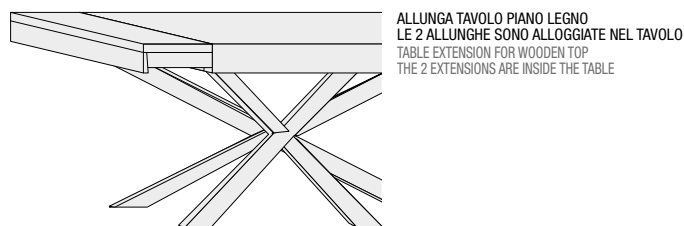

ALLUNGA TAVOLO PIANO LEGNO
LE 2 ALLUNGHE SONO ALLOGGiate NEL TAVOLO
TABLE EXTENSION FOR WOODEN TOP
THE 2 EXTENSIONS ARE INSIDE THE TABLE

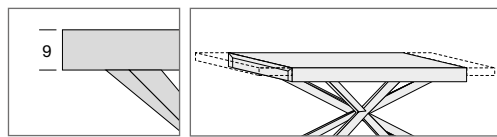

PROFILO PIANO LEGNO
WOODEN TOP PROFILE

PIANO RETTANGOLARE LEGNO CON 2 ALLUNGHE DA 42
WOODEN RECTANGULAR TOP WITH 2X42 CM WIDE
EXTENSIONS

PIANO IN CRISTALLO GLASS TOP

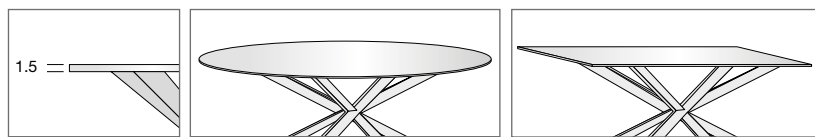

PROFILO PIANO CRISTALLO
GLASS TOP PROFILE

PIANO OVALE CRISTALLO
GLASS OVAL TOP

PIANO RETTANGOLARE CRISTALLO
GLASS RECTANGULAR TOP

TAVOLO LEGNO E CRISTALLO

PIANO E ALLUNGHE LEGNO	PANNELLO DI LISTELLARE IMPIALLACCIATO IN NOCE O FRASSINO SPAZZOLATO SP. CM. 2.5, VERNICIATO O LACCATO A PORO APERTO. 2 ALLUNGHE DA 42 CM.
PIANO CRISTALLO	VETRO TEMPERATO SP. CM. 1.5.
CASSETTI ALLUNGHE	MASSELLO DI TOULIPIER O FRASSINO SPAZZOLATO SP. CM. 1.8 VERNICIATO O LACCATO A PORO APERTO.
GAMBA IN LEGNO	MASSELLO DI TOULIPIER SP. CM. 8, VERNICIATO O LACCATO A PORO APERTO.

WOODEN AND GLASS TABLE

WOODEN EXTENSIONS AND TOP	BLOCKBOARD PANEL VENEERED IN WALNUT OR BRUSHED ASHWOOD TH. CM. 2.5, PAINTED OR OPEN PORE LACQUERED. 2 ALLUNGHE DA 42 CM.
GLASS TOP	TEMPERED GLASS TH. CM. 1.5.
EXTENSION DRAWERS	TOULIPIER SOLID WOOD OR BRUSHED SOLID ASHWOOD TH. CM. 1.8 PAINTED OR OPEN PORE LACQUERED.
WOODEN LEG	TOULIPIER SOLID WOOD TH. CM. 8, PAINTED OR OPEN PORE LACQUERED.

PANDORA

DECOR

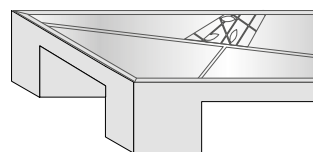

PIANO DECORATO CON TOP VETRO INCASSATO
NELLA STRUTTURA
DECORATED TOP WITH GLASS TOP BUILT IN THE
STRUCTURE

TAVOLINO QUADRATO E RETTANGOLARE

PIANO	PANNELLO DI LISTELLARE IMPIALLACCIATO IN NOCE O FRASSINO SPAZZOLATO SP. CM. 1.8, VERNICIATO O LACCATO A PORO APERTO.
DECORO	PANNELLO DI MDF IMPIALLACCIATO IN NOCE O FRASSINO SP. CM. 0.4, VERNICIATO O LACCATO A PORO APERTO.
STRUTTURA	MASSELLO DI TOULIPIER O FRASSINO SPAZZOLATO SP. CM. 2.6, VERNICIATO O LACCATO A PORO APERTO.
TOP	VETRO SP. CM. 0.6.

RECTANGULAR AND SQUARE TABLE

TOP	BLOCKBOARD PANEL VENEERED IN WALNUT OR BRUSHED ASHWOOD TH. CM. 1.8, PAINTED OR OPEN PORE LACQUERED.
DECORATION	MDF PANEL VENEERED IN WALNUT OR ASHWOOD TH. CM. 0.4, PAINTED OR OPEN PORE LACQUERED.
STRUCTURE	TOULIPIER SOLID WOOD OR BRUSHED SOLID ASHWOOD TH. CM. 2.6, PAINTED OR OPEN PORE LACQUERED.
TOP	GLASS TH. CM. 0.6.

LETTI BEDS

SENZA RETE E MATERASSO
WITHOUT BED BASE AND MATTRESS

LETTO CHLOE TESTIERA IMBOTTITA CHLOE BED UPHOLSTERED HEADBOARD

NEW

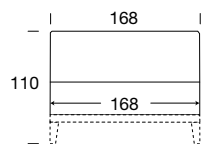

NOCE-FRASSINO / WALNUT-ASHWOOD

LETTO DA 160
160 CM WIDE BED

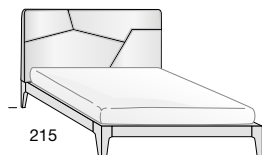

MISURE INTERNE 162X202 PER MATERASSO 160X200
INTERNAL DIMENSIONS 162X202 FOR MATTRESS 160X200

DCN5901K		
CAT. A	CAT. B	CAT. C
ECOPELLE/ECONABUK ECOLEATHER/ECONABUK	LINO/VELLUTO LINEN/VELVET	PELLE LEATHER
2.620	2.694	3.151

mc 0,70 – Kg 68

LETTO DA 160 CONTENITORE E RETE BASCULANTE
160 CM WIDE STORAGE BED AND TILTING BED BASE UNIT WITH

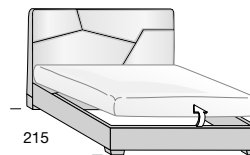

SPAZIO UTILE CONTENITORE H. CM 16 – MISURE INTERNE 162X204
STORAGE USEFUL SPACE H. CM 16 – INTERNAL DIMENSIONS 162X204

DCN5911K		
CAT. A	CAT. B	CAT. C
ECOPELLE/ECONABUK ECOLEATHER/ECONABUK	LINO/VELLUTO LINEN/VELVET	PELLE LEATHER
3.955	4.017	4.354

mc 0,70 – Kg 68

MAGGIORAZIONI E RIDUZIONI
SURCHARGES AND REDUCTIONS

PER LONGHERONI PIÙ LUNGHI
O PIÙ CORTI APPLICARE
MAGG. DEL
FOR LONGER OR SHORTER
SIDES PLEASE ADD THE
FOLLOWING EXTRA CHARGE

+ 10%

OPTIONAL
OPTIONAL



+ 222

SOLLEVAMENTO ORIZZONTALE
HORIZONTAL LIFTING MECHANISM

LETTO DECOR PANNELLO LEGNO DECORATO DECOR BED DECORATED WOODEN PANEL

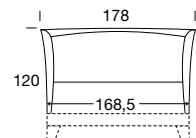

NOCE-FRASSINO / WALNUT-ASHWOOD

LETTO DA 160
160 CM WIDE BED

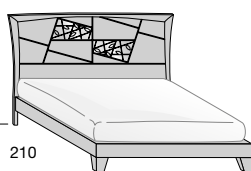

MISURE INTERNE 162X202 PER MATERASSO 160X200
INTERNAL DIMENSIONS 162X202 FOR MATTRESS 160X200

DCN5301K		
2.608		

mc 0,55 – Kg 64

LETTO DA 160 CONTENITORE E RETE BASCULANTE
160 CM WIDE STORAGE BED AND TILTING BED BASE UNIT WITH

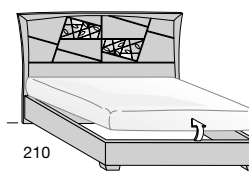

SPAZIO UTILE CONTENITORE H. CM 16 – MISURE INTERNE 162X204
STORAGE USEFUL SPACE H. CM 16 – INTERNAL DIMENSIONS 162X204

DCN5321K		
4.017		

mc 0,70 – Kg 70

LETTO MONDRIAN TESTIERA IMBOTTITA MONDRIAN BED UPHOLSTERED HEADBOARD

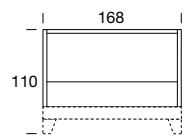

NOCE-FRASSINO / WALNUT-ASHWOOD

LETTO DA 160
160 CM WIDE BED

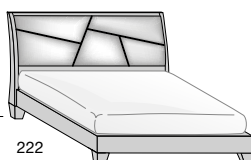

MISURE INTERNE 162X202 PER MATERASSO 160X200
INTERNAL DIMENSIONS 162X202 FOR MATTRESS 160X200

DCN5501K		
CAT. A	CAT. B	CAT. C
ECOPELLE/ECONABUK ECOLEATHER/ECONABUK	LINO/VELLUTO LINEN/VELVET	PELLE LEATHER
3.194	3.572	3.680

mc 0,55 – Kg 62

LETTO DA 160 CONTENITORE E RETE BASCULANTE
160 CM WIDE STORAGE BED AND TILTING BED BASE UNIT WITH

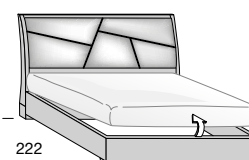

SPAZIO UTILE CONTENITORE H. CM 16 – MISURE INTERNE 162X204
STORAGE USEFUL SPACE H. CM 16 – INTERNAL DIMENSIONS 162X204

DCN5521K		
CAT. A	CAT. B	CAT. C
ECOPELLE/ECONABUK ECOLEATHER/ECONABUK	LINO/VELLUTO LINEN/VELVET	PELLE LEATHER
4.487	4.974	5.074

mc 0,70 – Kg 68

LETTO ODETTA TESTIERA LEGNO ODETTA BED WOODEN HEADBOARD

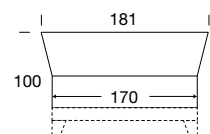

NOCE-FRASSINO / WALNUT-ASHWOOD

LETTO DA 160
160 CM WIDE BED

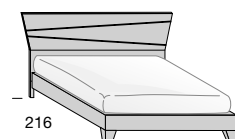

MISURE INTERNE 162X202 PER MATERASSO 160X200
INTERNAL DIMENSIONS 162X202 FOR MATTRESS 160X200

DCN5001K		
2.169		

mc 0,55 – Kg 60

LETTO DA 160 CONTENITORE E RETE BASCULANTE
160 CM WIDE STORAGE BED AND TILTING BED BASE UNIT WITH

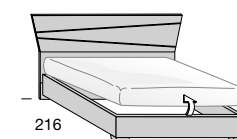

SPAZIO UTILE CONTENITORE H. CM 16 – MISURE INTERNE 162X204
STORAGE USEFUL SPACE H. CM 16 – INTERNAL DIMENSIONS 162X204

DCN5021K		
3.639		

mc 0,70 – Kg 66

RETE A DOGHE
SLATTED BED BASE

RETE 160x200 PER LETTI
DA 160
BED BASE 160x200 FOR
160 CM WIDE BEDS

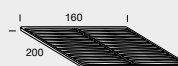

ACS5160K

433

ARMADI WARDROBES

PER SPECIFICHE MONTAGGIO VEDI PAG. 61
FOR ASSEMBLY SPECIFICATIONS SEE PAGE 61

DECOR

2 ANTE SCORREVOLI
2 SLIDING DOORS

ATTREZZATURA INTERNA: 2 RIPIANI,
4 TUBI APPENDIABILI

INTERIOR FITTINGS: 2 SHELVES,
4 CLOTHES HANGING RAILS

MAGGIORAZIONE PER SCOCCA ARMADIO IN
PANNELLO IN LEGNO
INCREASE FOR WARDROBE STRUCTURE IN WOOD
PANEL.

+ 532

NOCE-FRASSINO / WALNUT-ASHWOOD

ARMADIO 2 ANTE SCORREVOLI
WARDROBE WITH 2 WIDE SLIDING DOORS

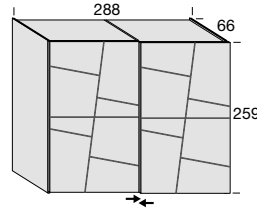

MAGG. ANTA SPORGENTE A SX
SURCH. FOR LH PROTRUDING DOOR + 5%

DCN8061K	OPTIONAL
	L. 140
5.228	+ 470
mc 1,30 – Kg 258	mc 0,44 – Kg 54

ARMADIO 2 ANTE SCORREVOLI
WARDROBE WITH 2 WIDE SLIDING DOORS

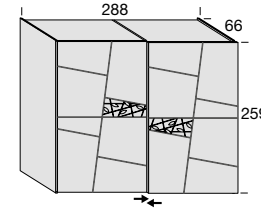

CON DECORO FOGLIA
WITH LEAF DECORATION

MAGG. ANTA SPORGENTE A SX
SURCH. FOR LH PROTRUDING DOOR + 5%

DCN8001K	OPTIONAL
	L. 140
5.468	+ 470
mc 1,30 – Kg 258	mc 0,44 – Kg 54

DECOR

3 ANTE SCORREVOLI
3 SLIDING DOORS

ATTREZZATURA INTERNA: 3 RIPIANI,
6 TUBI APPENDIABILI

INTERIOR FITTINGS: 3 SHELVES,
6 CLOTHES HANGING RAILS

MAGGIORAZIONE PER SCOCCA ARMADIO IN
PANNELLO DI LEGNO
INCREASE FOR WARDROBE STRUCTURE IN WOOD
PANEL.

+ 582

NOCE-FRASSINO / WALNUT-ASHWOOD

ARMADIO 3 ANTE SCORREVOLI
WARDROBE WITH 3 WIDE SLIDING DOORS

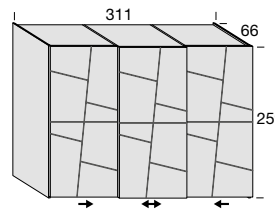

DCN8361K	OPTIONAL
	L. 100
7.026	+ 451
mc 1,40 – Kg 290	mc 0,44 – Kg 54

ARMADIO 3 ANTE SCORREVOLI
WARDROBE WITH 3 WIDE SLIDING DOORS

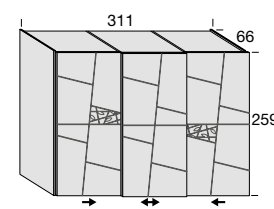

ANTE ESTERNE DECORO FOGLIA
EXTERNAL DOORS WITH LEAF DECORATION

DCN8301K	OPTIONAL
	L. 100
7.099	+ 451
mc 1,40 – Kg 290	mc 0,35 – Kg 42

DECOR

3 ANTE SCORREVOLI
3 SLIDING DOORS

ATTREZZATURA INTERNA: 3 RIPIANI,
6 TUBI APPENDIABILI

INTERIOR FITTINGS: 3 SHELVES,
6 CLOTHES HANGING RAILS

MAGGIORAZIONE PER SCOCCA ARMADIO IN
PANNELLO DI LEGNO
INCREASE FOR WARDROBE STRUCTURE IN WOOD
PANEL.

+ 606

NOCE-FRASSINO / WALNUT-ASHWOOD

ARMADIO 3 ANTE SCORREVOLI
WARDROBE WITH 3 WIDE SLIDING DOORS

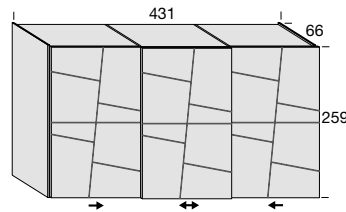

DCN8561K	OPTIONAL
	L. 140
7.637	+ 470
mc 1,75 – Kg 380	mc 0,44 – Kg 54

ARMADIO 3 ANTE SCORREVOLI
WARDROBE WITH 3 WIDE SLIDING DOORS

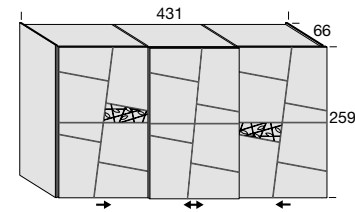

ANTE ESTERNE CON DECORO FOGLIA
EXTERNAL DOORS WITH LEAF DECORATION

DCN8501K	OPTIONAL
	L. 140
7.718	+ 470
mc 1,75 – Kg 380	mc 0,44 – Kg 54

ATTREZZATURA INTERNA DECORATIVO COLOR OLMO SBIANCATO

INTERIOR FITTINGS
BLEACHED ELM DECORATIVE
COLOR

PER ATTREZZATURA INTERNA FRASSINO
TINTO ACACIA VEDI PAG. 178
FOR INTERNAL EQUIPMENT IN STAINED
ACACIA SEE PAGE 178

DIVISORIO INTERNO SP. 2.5
INTERNAL PARTITIONS TH. 2.5

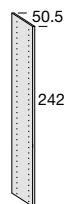

ACS1022C
415
mc 0,10 – Kg 24

DIVISORIO INTERNO SP. 2.5
INTERNAL PARTITIONS TH. 2.5

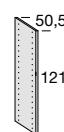

ACS1021C
222
mc 0,05 – Kg 10

KIT 2 LUCI LED L. 100
KIT FOR 2 LED LIGHTS W. 100



CON SENSORE E TRASFORMATORE (1 DX E 1 SX)
WITH SENSOR AND TRANSFORMER (1 RH AND 1 LH)

ACS1080K
637

CASSETTIERA "EASY" 3 CASSETTI
"EASY" DRAWER UNIT WITH 3 DRAWERS

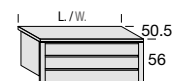

ACS3110K	ACS3100K
L.100	L.140
451	470
mc 0,35 – Kg 42	mc 0,44 – Kg 54

STRUTTURA INTERNA DECORATIVO COLOR OLMO SBIANCATO ED ESTERNO NOCE TANGANICA O FRASSINO
INTERNAL STRUCTURE IN BLEACHED ELM COLOR DECORATION AND EXTERNAL STRUCTURE IN TANGANICA WALNUT OR ASHWOOD

ARMADIO 2 ANTE SCORREVOLI WARDROBE WITH 2 WIDE SLIDING DOORS

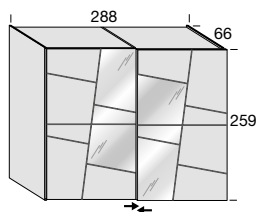

SPECCHIO ARGENTO
SILVER MIRROR

MAGG. ANTA SPORGENTE A SX
SURCH. FOR LH PROTRUDING DOOR + 5%

DCN8041K	OPTIONAL	
	L. 140	SPECCHI MIRRORS
5.679	+ 470	+ 229
mc 1,30 - Kg 273	mc 0,44 - Kg 54	

ARMADIO 2 ANTE SCORREVOLI WARDROBE WITH 2 WIDE SLIDING DOORS

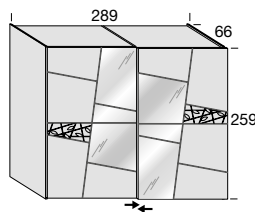

SPECCHIO ARGENTO E DECORO FOGLIA
SILVER MIRROR AND LEAF DECORATION

MAGG. ANTA SPORGENTE A SX
SURCH. FOR LH PROTRUDING DOOR + 5%

DCN8051K	OPTIONAL	
	L. 140	SPECCHI MIRRORS
5.734	+ 470	+ 229
mc 1,30 - Kg 273	mc 0,44 - Kg 54	

MAGGIORAZIONI E RIDUZIONI SURCHARGES AND REDUCTIONS

RIDUZIONI SINGOLE
SINGLE ADJUSTMENTS

LUNGHEZZA LENGTH	+ 30%
PROFONDITÀ DEPTH	
ALTEZZA HEIGHT	

RIDUZIONI COMBinate TRA LORO
COMBINED ADJUSTMENTS

RIDUZIONE DI 2 MISURE REDUCTION OF 2 DIMENSIONS	+ 40%
--	-------

ES. RIDUZIONE IN LUNGHEZZA +
PROFONDITÀ O PROFONDITÀ + ALTEZZA ECC.
EX. OF REDUCTION IN LENGTH +
DEPTH OR DEPTH + HEIGHT ETC.

ARMADIO 3 ANTE SCORREVOLI WARDROBE WITH 3 WIDE SLIDING DOORS

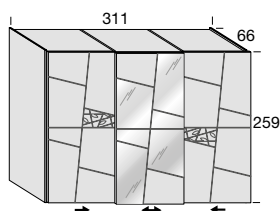

ANTA CENTRALE SPECCHIO ARGENTO E ANTE ESTERNE DECORO FOGLIA
CENTRAL DOOR WITH SILVER MIRROR AND EXTERNAL DOORS WITH LEAF DECORATION

DCN8341K	OPTIONAL	
	L. 100	SPECCHI MIRRORS
7.446	+ 451	+ 229
mc 1,40 - Kg 294	mc 1,40 - Kg 294	

ARMADIO 3 ANTE SCORREVOLI WARDROBE WITH 3 WIDE SLIDING DOORS

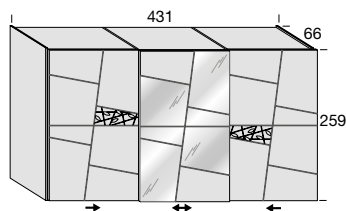

ANTA CENTRALE SPECCHIO ARGENTO E ANTE ESTERNE DECORO FOGLIA
CENTRAL DOOR WITH SILVER MIRROR AND EXTERNAL DOORS WITH LEAF DECORATION

DCN8541K	OPTIONAL	
	L. 140	SPECCHI MIRRORS
8.047	+ 470	+ 229
mc 1,75 - Kg 395	mc 0,44 - Kg 54	

RIPIANI SP. 3,6 CM SHELVES TH. 3,6 CM



ACS1014C	ACS1013C	ACS1012C	ACS1016C	ACS1011C
L. 45	L. 70	L. 90	L. 100	L. 140
136	162	186	229	241
mc 0,04 - Kg 4	mc 0,05 - Kg 8	mc 0,05 - Kg 11	mc 0,06 - Kg 13	mc 0,07 - Kg 15

TUBO APPENDIABITI CLOTHES HANGING RAILS



ACS1104C	ACS1103C	ACS1102C	ACS1106C	ACS1101C
L. 45	L. 70	L. 90	L. 100	L. 140
44	44	55	55	55

OPTIONAL OPTIONAL

CASSETTIERA "EASY" 3 CASSETTI
"EASY" DRAWER UNIT WITH 3 DRAWERS

SPECCHI MIRRORS
MAGGIORAZIONE SPECCHI TUTTI
BRONZO O TUTTI FUMÉ
SURCHARGE EVERY BRONZE OR
SMOKED GREY MIRRORS

POSSIBILITÀ DI FRONTALE DIVERSO
DALLA SCOCCA, SPECIFICARE LA
FINITURA SCELTA

IN CASE OF FRONT DIFERENT FROM
THE CARCASE CONSIDER THE
HIGHER PRICE OF THE CHOOSEN
FINISH

DECOR NOTTE - NIGHT

COMODINO, COMÒ, SETTIMINO E SPECCHIERE

BEDSIDE TABLE, CHEST OF DRAWERS, 6-DRAWER CHEST AND MIRRORS

COMODINO, COMÒ, SETTIMINO DECOR

DECOR BEDSIDE TABLE,
CHEST OF DRAWER AND
6-DRAWER CHEST

COMODINO 2 CASSETTI
BEDSIDE TABLE WITH 2 DRAWERS

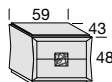

APERTURA PUSH-PULL
PUSH-PULL OPENING

DCN7001K

COMÒ 4 CASSETTI
4-DRAWER CHEST

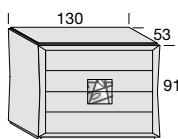

APERTURA PUSH-PULL
PUSH-PULL OPENING

DCN6001K

SETTIMINO 6 CASSETTI
6-DRAWER CHEST

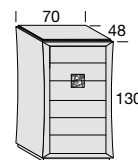

APERTURA PUSH-PULL
PUSH-PULL OPENING

DCN6041K

LE RIDUZIONI IN ALTEZZA
SONO DA VALUTARE SINGOLARMENTE
HEIGHT REDUCTION
HAVE TO BE EVALUATE SEPARATELY

NOCE-FRASSINO / WALNUT-ASHWOOD

1.130

mc 0,18 – Kg 25

2.452

mc 0,82 – Kg 82

2.452

mc 0,60 – Kg 71

COMODINO, COMÒ MONDRIAN

BEDSIDE TABLE,
CHEST OF DRAWER
MONDRIAN

COMODINO 2 CASSETTI
BEDSIDE TABLE WITH 2 DRAWERS

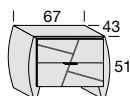

APERTURA CON MANIGLIE
OPENING WITH HANDLES

DCN7701K

COMÒ 3 CASSETTI
3-DRAWER CHEST

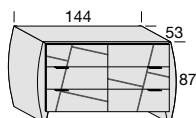

APERTURA CON MANIGLIE
OPENING WITH HANDLES

DCN6621K

COMÒ 3 CASSETTI
3-DRAWER CHEST

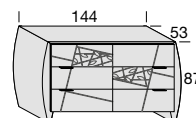

CON DECORO FOGLIA, APERTURA CON MANIGLIE
WITH LEAF DECORATION, OPENING WITH HANDLES

DCN6601K

NOCE-FRASSINO / WALNUT-ASHWOOD

1.305

mc 0,20 – Kg 27

2.831

mc 0,82 – Kg 90

2.856

mc 0,82 – Kg 90

SETTIMINO MONDRIAN

MONDRIAN
6-DRAWER CHEST

SETTIMINO 6 CASSETTI
6-DRAWER CHEST

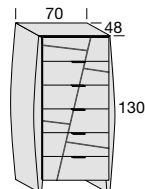

APERTURA CON MANIGLIE
OPENING WITH HANDLES

DCN6641K

NOCE-FRASSINO / WALNUT-ASHWOOD

2.856

mc 0,70 – Kg 81

SPECCHIERE MIRRORS

SPECCHIERA ELIOS
ELIOS MIRROR

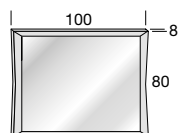

CORNICE IN LEGNO
WOODEN FRAME

DCN9010K

NOCE-FRASSINO / WALNUT-ASHWOOD

711

mc 0,08 – Kg 14

SPECCHIERA DECOR
DECOR MIRROR

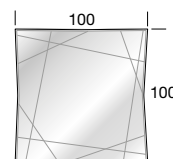

VETRO INCISO
RIDGED GLASS

DCN9001K

672

mc 0,11 – Kg 27

MAGGIORAZIONI E RIDUZIONI SURCHARGES AND REDUCTIONS

RIDUZIONI SINGOLE SINGLE ADJUSTMENTS

LUNGHEZZA LENGTH	+ 30%
PROFONDITÀ DEPTH	
NO RIDUZIONI IN ALTEZZA HEIGHT REDUCTIONS NOT POSSIBLE	

RIDUZIONI COMBinate TRA LORO COMBINED ADJUSTMENTS

LUNGHEZZA + PROFONDITÀ LENGTH + DEPTH	+ 40%
--	-------

PER ULTERIORI MODIFICHE
RICHIEDERE PREVENTIVO
FOR MODIFICATIONS
ASK FOR AN ESTIMATE.

VETRINE E CREDENZE DISPLAY UNITS AND SIDEBOARDS

VETRINA DECOR DECORO INCISO SU VETRO

DECOR DISPLAY UNIT EDGED DECORATION ON GLASS

LE RIDUZIONI IN ALTEZZA SONO DA VALUTARE SINGOLARMENTE
HEIGHT REDUCTION HAVE TO BE EVALUATE SEPARATELY

NOCE-FRASSINO / WALNUT-ASHWOOD

VETRINA 1 ANTA SX
DISPLAY UNIT WITH 1 DOOR LH

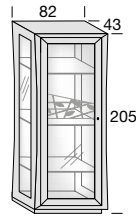

DCG3121K	OPTIONAL
	1 LED
2.398	+ 118
mc 0,94 - Kg 66	

VETRINA 1 ANTA DX
DISPLAY UNIT WITH 1 DOOR RH

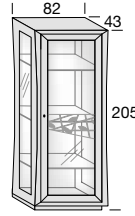

DCG3021K	OPTIONAL
	1 LED
2.398	+ 118
mc 0,94 - Kg 66	

VETRINA 2 ANTE
DISPLAY UNIT WITH 2 DOORS

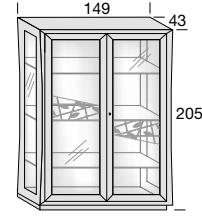

DCG3061K	OPTIONAL
	2 LED
3.336	+ 235
mc 1,55 - Kg 90	

VETRINA DECOR WOOD PANNELLO E DECORO LEGNO

DECOR WOOD DISPLAY UNIT PANEL AND WOODEN DECORATION

LE RIDUZIONI IN ALTEZZA SONO DA VALUTARE SINGOLARMENTE
HEIGHT REDUCTION HAVE TO BE EVALUATE SEPARATELY

NOCE-FRASSINO / WALNUT-ASHWOOD

VETRINA 1 ANTA SX
DISPLAY UNIT WITH 1 DOOR LH

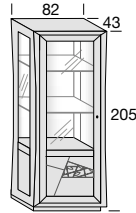

*

DCG3131K	OPTIONAL
	1 LED
2.781	+ 118
mc 0,95 - Kg 70	

VETRINA 1 ANTA DX
DISPLAY UNIT WITH 1 DOOR RH

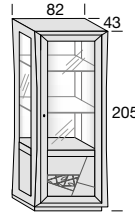

*

DCG3031K	OPTIONAL
	1 LED
2.781	+ 118
mc 0,95 - Kg 70	

VETRINA 2 ANTE
DISPLAY UNIT WITH 2 DOORS

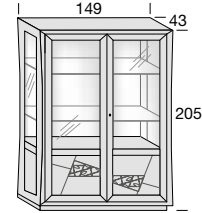

*

DCG3091K	OPTIONAL
	2 LED
3.801	+ 235
mc 1,55 - Kg 96	

CREDENZE DECOR DECOR SIDEBOARDS

1 RIPIANO LEGNO AL POSTI DI VETRO + 94
1 WOODEN SHELF IN PLACE OF GLASS

LE RIDUZIONI IN ALTEZZA SONO DA VALUTARE SINGOLARMENTE
HEIGHT REDUCTION HAVE TO BE EVALUATE SEPARATELY

NOCE-FRASSINO / WALNUT-ASHWOOD

CREDENZA 2 ANTE, 2 RIPIANI VETRO
SIDEBOARD WITH 2 DOORS, 2 GLASS SHELVES

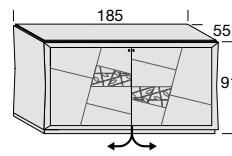

*

DCG2021K	OPTIONAL
	ACS2000K
	2 CASSETTI INTERNI 2 INTERNAL DRAWERS
3.121	+ 587
mc 1,20 - Kg 86	mc 0,20 - Kg 10

CREDENZA 3 ANTE, 3 RIPIANI VETRO
SIDEBOARD WITH 3 DOORS, 3 GLASS SHELVES

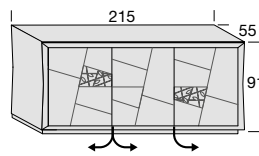

*

DCG2061K	OPTIONAL
	1 CASSETTO INTERNO 1 INTERNAL DRAWER
3.417	+ 309
mc 1,40 - Kg 96	

CREDENZA 2 ANTE E 3 CASSETTI CENTRALI,
2 RIPIANI VETRO
SIDEBOARD WITH 2 DOORS AND 3 CENTRAL,
2 GLASS SHELVES

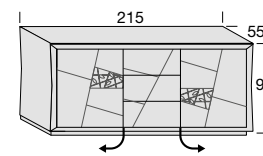

*

DCG2051K	
APERTURA PUSH-PULL PUSH-PULL OPENING	
4.109	
mc 1,40 - Kg 96	

CREDENZA MONDRIAN MONDRIAN SIDEBOARD

RIPIANI LEGNO AL POSTO DI VETRO + 186
WOODEN SHELVES INSTEAD OF GLASS SHELVES

LE RIDUZIONI IN ALTEZZA SONO DA VALUTARE SINGOLARMENTE
HEIGHT REDUCTION HAVE TO BE EVALUATE SEPARATELY

NOCE-FRASSINO / WALNUT-ASHWOOD

CREDENZA 2 ANTE,
2 RIPIANI VETRO
SIDEBOARD WITH 2 DOORS,
2 GLASS SHELVES

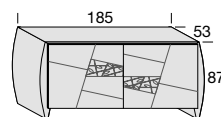

*

DCG2221K	
APERTURA CON MANIGLIE OPENING WITH HANDLES	
3.399	
mc 1,00 - Kg 90	

CASSETTIERA 2 CASSETTI
INTERNA ALLA CREDENZA
CON GUIDE AMMORTIZZATE
DRAWER UNIT WITH 2 DRAWERS
INSIDE THE SIDEBOARD WITH
SOFT-CLOSE GUIDES

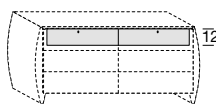

OPTIONAL
ACS2200K
624
mc 0,20 - Kg 10

CONSOLLE DECOR DECOR CONSOLE

CONSOLLE 1 CASSETTO
1 DRAWER CONSOLE

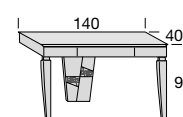

DCN7841K
2.331
mc ??? - Kg ???

MAGGIORAZIONI E RIDUZIONI SURCHARGES AND REDUCTIONS

RIDUZIONI SINGOLE SINGLE ADJUSTMENTS

LUNGHEZZA LENGTH	+ 30%
PROFONDITÀ DEPTH	

RIDUZIONI COMBinate TRA LORO COMBINED ADJUSTMENTS

LUNGHEZZA + PROFONDITÀ LENGTH + DEPTH	+ 40%
--	-------

PER ULTERIORI MODIFICHE
RICHIEDERE PREVENTIVO
FOR MODIFICATIONS
ASK FOR AN ESTIMATE.

OPTIONAL OPTIONAL

LED	
	1 LED
	2 LEDS

*
SPECIFICARE CON O
SENZA DECORO FOGLIA
(IL PREZZO È LO STESSO)
PLEASE SPECIFY WITH
OR WITHOUT LEAF
DECORATION
(THE PRICE IS THE SAME)

DECOR GIORNO - DAY

TAVOLI TABLES

TAVOLO PANDORA PANDORA TABLE

TAVOLO RETTANGOLARE FISSO
RECTANGULAR FIXED TABLE

NEW

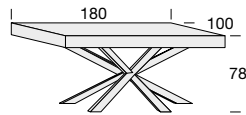

DCG4231K	OPTIONAL
	PIANO - TOP SAHARA NOIRE KALACATTA
3.245	+1.251

mc 1,23 - Kg 125

TAVOLO RETTANGOLARE FISSO
RECTANGULAR FIXED TABLE

NEW

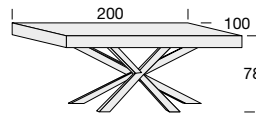

DCG4241K	OPTIONAL
	PIANO - TOP SAHARA NOIRE KALACATTA
3.398	+1.386

mc 1,30 - Kg 130

NON SONO POSSIBILI RIDUZIONI ALLE GAMBE
LEG REDUCTIONS NOT POSSIBLE

NOCE-FRASSINO / WALNUT-ASHWOOD

MAGGIORAZIONI E RIDUZIONI
SURCHARGES AND REDUCTIONS

PER MODIFICHE E
RIDUZIONI TAVOLI,
RICHIEDERE PREVENTIVO
FOR TABLE MODIFICATIONS
AND REDUCTIONS, ASK
FOR AN ESTIMATE

TAVOLO RETTANGOLARE ALLUNGABILE
RECTANGULAR EXTENDING TABLE

RIDUZIONE FINO MAX. 160X80 (2 ALLUNGHE DA 30)
REDUCTION UP TO MAX. 160X80 (2X30 CM WIDE EXTENSIONS)

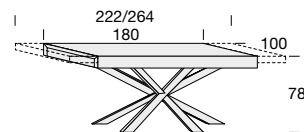

2 ALLUNGHE DA 42
2 42 CM WIDE EXTENSIONS

DCG4031K
4.099

mc 1,23 - Kg 125

TAVOLO CON PIANO RETTANGOLARE IN CRISTALLO
TABLE WITH RECTANGULAR GLASS TOP

RIDUZIONE FINO MAX. 160X80
REDUCTION UP TO MAX. 160X80

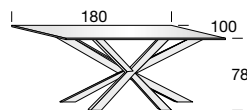

VETRO TRASPARENTE
TRANSPARENT GLASS

DCG4141K
3.675

mc 1,23 - Kg 62

TAVOLO CON PIANO OVALE IN CRISTALLO
TABLE WITH OVAL GLASS TOP

RIDUZIONE FINO MAX. 190X120
REDUCTION UP TO MAX. 190X120

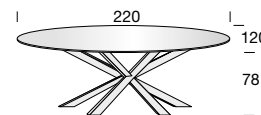

VETRO TRASPARENTE
TRANSPARENT GLASS

DCG4131K
4.365

mc 1,23 - Kg 70

NON SONO POSSIBILI RIDUZIONI ALLE GAMBE
LEG REDUCTIONS NOT POSSIBLE

NOCE-FRASSINO / WALNUT-ASHWOOD

TAVOLO DECOR DECOR TABLE

TAVOLO QUADRATO FISSO
SQUARE FIXED TABLE

NEW

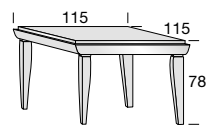

DCG4221K
2.218

mc 0,32 - Kg 42

TAVOLO RETTANGOLARE FISSO
RECTANGULAR FIXED TABLE

NEW

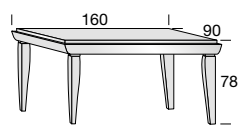

DCG4201K
2.301

mc 0,35 - Kg 47

TAVOLO RETTANGOLARE FISSO
RECTANGULAR FIXED TABLE

NEW

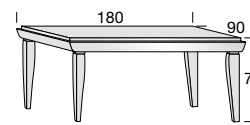

DCG4211K
2.537

mc 0,38 - Kg 50

NOCE-FRASSINO / WALNUT-ASHWOOD

TAVOLO QUADRATO ALLUNGABILE
SQUARE EXTENDING TABLE

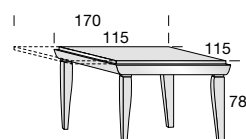

ALLUNGA DA 55
55 CM WIDE EXTENSION

DCG4021K
2.601

mc 0,32 - Kg 42

TAVOLO RETTANGOLARE ALLUNGABILE
RECTANGULAR EXTENDING TABLE

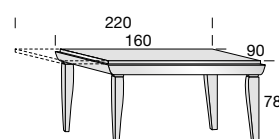

ALLUNGA DA 60
60 CM WIDE EXTENSION

DCG4001K
2.654

mc 0,35 - Kg 47

TAVOLO RETTANGOLARE ALLUNGABILE
RECTANGULAR EXTENDING TABLE

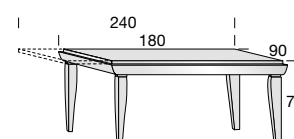

ALLUNGA DA 60
60 CM WIDE EXTENSION

DCG4011K
2.943

mc 0,38 - Kg 50

NOCE-FRASSINO / WALNUT-ASHWOOD

TAVOLINI, SEDIE, PORTA TV E MADIE
COFFEE TABLES, CHAIRS, TV UNIT AND CUPBOARDS

TAVOLINO DECOR
CON DECORO FOGLIA
DECOR SMALL TABLES
WITH LEAF DECORATION

NEW

NEW

VETRO SU TOP GLASS ON TOP	VETRO SU TOP GLASS ON TOP	VETRO SU TOP GLASS ON TOP	VETRO SU TOP GLASS ON TOP
DCG4550K	DCG4570K	DCG4560K	DCG4580K
1.263	1.386	1.410	1.546
mc 0,26 – Kg 40	mc 0,38 – Kg 45	mc 0,27 – Kg 42	mc 0,40 – Kg 47

NOCE-FRASSINO / WALNUT-ASHWOOD

SEDIE
CHAIRS

SEDIA DECOR
DECOR CHAIR

SEDIA ELLE
ELLE CHAIR

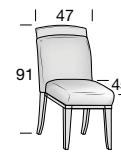
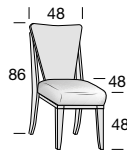

SEDILE IMBOTTITO
UPHOLSTERED SEAT

SEDILE E SCHIENALE IMBOTTITO
UPHOLSTERED BACK PANEL AND SEAT

CML1301K			CML1331K		
CAT. A	CAT. B	CAT. C	CAT. A	CAT. B	CAT. C
ECOPELLE/ECONABUK ECOLEATHER/ECONABUK	LINO/VELLUTO LINEN/VELVET	PELLE LEATHER	ECOPELLE/ECONABUK ECOLEATHER/ECONABUK	LINO/VELLUTO LINEN/VELVET	PELLE LEATHER
548	649	743	590	655	862
mc 0,30 – Kg 8			mc 0,30 – Kg 10		

NOCE-FRASSINO / WALNUT-ASHWOOD

PORTA TV E MADIE DECOR
DECOR TV UNIT AND
CUPBOARDS

BASE PORTA TV 2 ANTE, 1 CASSETTO E VANO
A GIORNO
TV BASE UNIT WITH 2 DOORS, 1 DRAWER AND
OPEN COMPART.

2 ANTE DECORATE, 3 CASSETTI, 2 RIPIANI
VETRO
2 DECORATED DOORS, 3 DRAWERS, 2 GLASS
SHELVES

2 ANTE VETRO, 2 ANTE DECORATE,
4 RIPIANI VETRO
2 GLASS DOORS, 2 DECORATED DOORS,
4 GLASS SHELVES

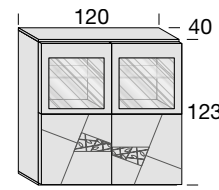
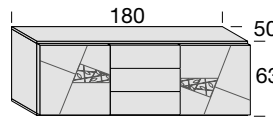
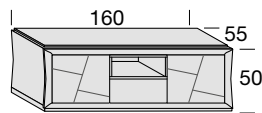

FIANCHI SAGOMATI
SHAPED SIDE PANELS

FIANCHI DRITTI
STRAIGHT SIDE PANELS

FIANCHI DRITTI
STRAIGHT SIDE PANELS

DCG7801K	DCC6205K	DCC6241K
2.386	2.987	2.610
mc 0,45 – Kg 55	mc 0,67 – Kg 100	mc 0,70 – Kg 52

NOCE-FRASSINO / WALNUT-ASHWOOD

ACCESSORI OPTIONAL
OPTIONAL ACCESSORIES

MULTIPRESA A SCOMPARSA CON SPORTELLINO
APRI/CHIUDI IN METALLO
CONCEALED MULTIPLE SOCKET WITH METAL
OPEN/CLOSE FLAP

KIT SPORTELLO
PASSACAVI + BORCHIA
KIT FOR CABLE
MANAGEMENT HOLE +
COVER

BARRA LED A BASSO
CONSUMO
ACCENSIONE TOUCH
IN ALLUMINIO L. 37.2
LOW CONSUMPTION
LED BAR TOUCH SWITCH
IN ALUMINIUM W. 37.2

ALIMENTATORE
POWER SUPPLY

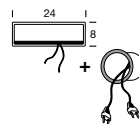

VERSIONE TV:
1 PRESA SCHUKO
2 PRESE USB RICARICA
1 PRESA SAT.

VERSIONE PC/MAC:
1 PRESA SCHUKO
2 PORTE USB DATI
1 PORTA HDMI

ZZZFE22030	ZZZFE22031	ZZZFE22005	ZZZFE22001	ZZZFE22002
595	595	133	163	66

COLLEGAMENTO
A CARICO DEL CLIENTE
CONNECTIONS
TO BE MADE BY THE CUSTOMER.

MAGGIORAZIONI E RIDUZIONI
SURCHARGES AND REDUCTIONS

RIDUZIONI SINGOLE
SINGLE ADJUSTMENTS

LUNGHEZZA LENGTH	+ 30%
PROFONDITÀ DEPTH	

RIDUZIONI COMBinate TRA LORO
COMBINED ADJUSTMENTS

LUNGHEZZA + PROFONDITÀ LENGTH + DEPTH	+ 40%
--	-------

PER ULTERIORI MODIFICHE
RICHIEDERE PREVENTIVO
FOR MODIFICATIONS
ASK FOR AN ESTIMATE.

*
SPECIFICARE CON O
SENZA DECORO FOGLIA
(IL PREZZO È LO STESSO)
PLEASE SPECIFY WITH
OR WITHOUT LEAF
DECORATION
(THE PRICE IS THE SAME)

COMPOSIZIONE 120 COMPOSITION 120

		NOCE FRASSINO
1	DCN5501K LETTO MONDRIAN DA 160 CON TESTIERA IMBOTTITA ECOPELLE (CAT. A) 160 CM WIDE MONDRIAN BED WITH ECOLEATHER UPHOLSTERED HEADBOARD (CAT. A)	3.194
1	DCN6601K COMO MONDRIAN 3 CASSETTI DECORO LEGNO MONDRIAN 3-DRAWER CHEST W/WOODEN DECORATION	2.856
2	DCN7701K COMODINO MONDRIAN 2 CASSETTI MONDRIAN BEDSIDE TABLE WITH 2 DRAWERS	2.610
1	DCN8001K ARMADIO DECOR 2 ANTE SCORREVOLI CON DECORO LEGNO DECOR WARDROBE WITH 2 SLIDING DOORS AND WOODEN DECORATION	5.468
PREZZO TOTALE COMPOSIZIONE TOTAL PRICE FOR COMPOSITION		14.128



COMPOSIZIONE 109 COMPOSITION 109

		NOCE FRASSINO
1	DCN5501K LETTO MONDRIAN DA 160 CON PANNELLO IMBOTTITO VELLUTO (CAT. B) 160 CM WIDE MONDRIAN BED WITH VELVET UPHOLSTERED PANEL (CAT. B)	3.572
1	DCN6001K COMO DECOR 4 CASSETTI CON DECORO LEGNO DECOR 4-DRAWER CHEST WITH WOODEN DECORATION	2.452
2	DCN7001K COMODINO DECOR 2 CASSETTI CON DECORO LEGNO DECOR BEDSIDE TABLE WITH 2 DRAWERS AND WOODEN DECORATION	2.260
1	DCN8341K ARMADIO DECOR 3 ANTE SCORREVOLI CON DECORO LEGNO E SPECCHIO ARGENTO DECOR WARDROBE WITH 3 SLIDING DOORS, WOODEN DECORATION AND SILVER MIRROR	7.446
PREZZO TOTALE COMPOSIZIONE TOTAL PRICE FOR COMPOSITION		15.730



COMPOSIZIONE 123 COMPOSITION 123

		NOCE FRASSINO
1	DCN5001K LETTO ODETTA DA 160 CON TESTIERA LEGNO 160 CM WIDE ODETTA BED WITH WOODEN HEADBOARD	2.169
1	DCN6001K COMO DECOR 4 CASSETTI CON DECORO LEGNO DECOR 4-DRAWER CHEST WITH WOODEN DECORATION	2.452
2	DCN7001K COMODINO DECOR 2 CASSETTI CON DECORO LEGNO DECOR BEDSIDE TABLE WITH 2 DRAWERS AND WOODEN DECORATION	2.260
PREZZO TOTALE COMPOSIZIONE TOTAL PRICE FOR COMPOSITION		6.881



COMPOSIZIONE 122/B COMPOSITION 122/B

NEW

		NOCE FRASSINO
1	DCN5301K LETTO DECOR DA 160 CON TESTIERA LEGNO 160 CM WIDE DECOR BED WITH WOODEN HEADBOARD	2.608
1	DCN6001K COMO DECOR 4 CASSETTI CON DECORO LEGNO DECOR 4-DRAWER CHEST WITH WOODEN DECORATION	2.452
2	DCN7001K COMODINO DECOR 2 CASSETTI CON DECORO LEGNO DECOR BEDSIDE TABLE WITH 2 DRAWERS AND WOODEN DECORATION	2.260
1	DCN8041K ARMADIO DECOR 2 ANTE SCORREVOLI E SPECCHIO ARGENTO DECOR WARDROBE WITH 2 SLIDING DOORS AND SILVER MIRROR	5.679
PREZZO TOTALE COMPOSIZIONE TOTAL PRICE FOR COMPOSITION		12.999



COMPOSIZIONI A CATALOGO

CATALOGUE COMPOSITIONS

COMPOSIZIONE 110

COMPOSITION 110

		NOCE FRASSINO
1	DCG2221K CREDENZA MONDRIAN 2 ANTE CON DECORO LEGNO MONDRIAN SIDEROBOARD WITH 2 DOORS AND WOODEN DECORATION	3.399
1	DCG4031K TAVOLO PANDORA CON PIANO IN LEGNO ALLUNGABILE MIS. 180X100 PANDORA TABLE WITH WOODEN EXTENDING TOP DIM. 180X100	4.099
4	CML1301K SEDIA DECOR RIVESTITA ECONABUK CAT. A DECOR CHAIR WITH ECONABUK COVER CAT. A	2.192
1	DCC1112K COMPONIBILE DECOR 112/A DECOR MODULAR UNIT 112/A	9.854
PREZZO TOTALE COMPOSIZIONE TOTAL PRICE FOR COMPOSITION		19.454



COMPOSIZIONE 111

COMPOSITION 111

		NOCE FRASSINO
1	DCG4131K TAVOLO PANDORA CON PIANO OVALE IN CRISTALLO MIS. 220X120 PANDORA TABLE WITH GLASS OVAL TOP DIM. 220X120	4.365
1	DCG2051K CREDENZA DECOR 2 ANTE E 3 CASSETTI CON DECORO LEGNO DECOR SIDEROBOARD WITH 2 DOORS AND 3 DRAWERS WITH WOODEN DECORATION	4.109
4	CML1331K SEDIA ELLE RIVESTITA IN ECONABUK CAT. A ELLE CHAIR WITH ECONABUK COVER CAT. A	2.360
PREZZO TOTALE COMPOSIZIONE TOTAL PRICE FOR COMPOSITION		10.834



DECOR SISTEMA COMPONENTIBILE

DECOR MODULAR SYSTEM

CARATTERISTICHE TECNICHE E PARTICOLARITÀ DI UTILIZZO TECHNICAL CHARACTERISTICS AND PARTICULAR USE	78
ACCESSORI OPTIONAL - ELEMENTI COMUNI OPTIONAL ACCESSORIES - COMMUN ELEMENTS	84
BASI A TERRA P. 40 FLOOR-STANDING BASE UNIT D. 40	86
BASI A TERRA P. 50 FLOOR-STANDING BASE UNIT D. 50	90
BASI SOSPESE P. 40 SUSPENDED BASE UNITS D. 40	94
BASI SOSPESE P. 50 SUSPENDED BASE UNITS D. 50	96
PENSILI ORIZZONTALI P. 40 HORIZONTAL WALL UNITS D. 40	98
PENSILI VERTICALI P. 40/41 VERTICAL WALL UNITS D. 40/41	102
MADIE E VETRINE P. 40/50 CUPBOARDS AND DISPLAY UNITS D. 40/50	104
COMPOSIZIONI A CATALOGO CATALOGUE COMPOSITIONS	106

DECOR SISTEMA COMPONIBILE - MODULAR SYSTEM

CARATTERISTICHE TECNICHE E PARTICOLARITÀ DI UTILIZZO

TECHNICAL CHARACTERISTICS AND PARTICULAR USE

ANTE DOORS

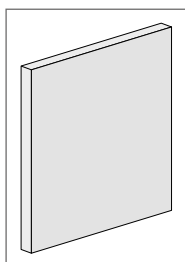

ANTA LEGNO
WOODEN DOOR

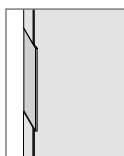

MANIGLIA MONDRIAN
MONDRIAN HANDLE

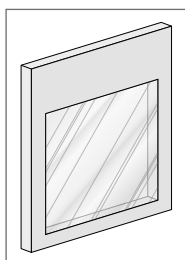

ANTA VETRO
GLASS DOOR



MANIGLIA MONDRIAN
MONDRIAN HANDLE

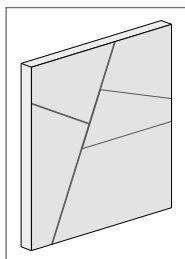

ANTA SENZA "DECORO FOGLIA"
DOOR WITHOUT "LEAF DECORATION"

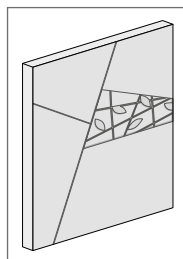

ANTA CON "DECORO FOGLIA"
DOOR WITH "LEAF DECORATION"

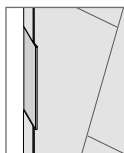

MANIGLIA MONDRIAN
MONDRIAN HANDLE

ANTA LEGNO PANNELLO DI LISTELLARE IMPIALLACCIATO NOCE O FRASSINO SPAZZOLATO SP. CM. 2.5 VERNICIATO O LACCATO PORO APERTO.

MANIGLIA PUSH-PULL O MANIGLIA MONDRIAN FINITURA ABBINATA ALL'ANTA.

CERNIERE AMMORTIZZATE DI SERIE

WOODEN DOOR BLOCKBOARD PANEL VENEERED IN WALNUT OR BRUSHED ASHWOOD TH. CM. 2.5 PAINTED OR OPEN PORE LACQUERED.

HANDLE PUSH-PULL OR MONDRIAN HANDLE. SAME FINISH AS THE DOOR.

STANDARD SOFT-CLOSE HINGES

ANTA VETRO PANNELLO DI LISTELLARE IMPIALLACCIATO NOCE O FRASSINO SPAZZOLATO SP. CM. 2.5 VERNICIATO O LACCATO PORO APERTO. VETRO FLOAT SP. CM. 0.4.

MANIGLIA PUSH-PULL O MANIGLIA MONDRIAN FINITURA ABBINATA ALL'ANTA.

CERNIERE AMMORTIZZATE DI SERIE

GLASS DOOR BLOCKBOARD PANEL VENEERED IN WALNUT OR BRUSHED ASHWOOD TH. CM. 2.5 PAINTED OR OPEN PORE LACQUERED. FLOAT GLASS TH. CM. 0.4.

HANDLE PUSH-PULL OR MONDRIAN HANDLE. SAME FINISH AS THE DOOR.

STANDARD SOFT-CLOSE HINGES

ANTA DECORATA MASSELLO DI TOULUPIER O FRASSINO SPAZZOLATO SP. CM. 2.5 E PANNELLO DECORATIVO IN MULTISTRATO IMPIALLACCIATO IN NOCE O FRASSINO SPAZZOLATO SP. CM. 0.5, VERNICIATO O LACCATO A PORO APERTO.

MANIGLIA PUSH-PULL O MANIGLIA MONDRIAN FINITURA ABBINATA ALL'ANTA.

CERNIERE AMMORTIZZATE DI SERIE

DECORATED DOOR TOULUPIER SOLID WOOD OR BRUSHED ASHWOOD TH. CM. 2.5 AND MULTILAYER DECORATIVE PANEL VENEERED IN WALNUT OR BRUSHED ASHWOOD TH. CM. 0.5, PAINTED OR OPEN PORE LACQUERED.

HANDLE PUSH-PULL OR MONDRIAN HANDLE. SAME FINISH AS THE DOOR.

STANDARD SOFT-CLOSE HINGES

CESTONI BASKETS

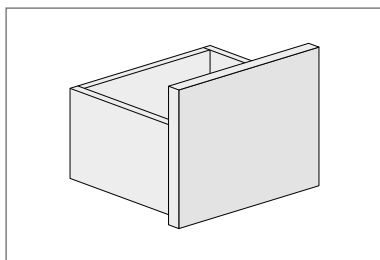

CESTONE LEGNO
WOODEN BASKET

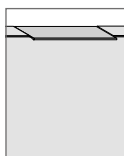

MANIGLIA MONDRIAN
MONDRIAN HANDLE

FRONTALE CESTONE PANNELLO DI LISTELLARE IMPIALLACCIATO NOCE O FRASSINO SPAZZOLATO SP. CM. 2.5 VERNICIATO O LACCATO A PORO APERTO.

STRUTTURA CESTONE PANNELLO DI MULTISTRATO BETULLA SPESSORE CM.1.5 CON INCASTRI A CODA DI RONDINE VERNICIATO TINTA ACACIA.

GUIDE CASSETTO REGOLABILI IN ALTEZZA E CON RICHIAMO AUTOMATICO AMMORTIZZATO

MANIGLIA CESTONE PUSH-PULL O MANIGLIA MONDRIAN IN FINITURA ABBIANATA AL FRONTALE CESTONE.

BASKET FRONT BLOCKBOARD PANEL VENEERED IN WALNUT OR BRUSHED ASHWOOD TH. CM. 2.5 OPEN PORE LACQUERED OR PAINTED.

BASKET STRUCTURE BIRCH MULTILAYER PANEL TH. CM.1.5 WITH DOVETAIL JOINTS ACACIA STAINED PAINTED.

DRAWER GUIDES ADJUSTABLE IN HEIGHT AND SOFT-CLOSE SELF-CLOSING MECHANISM

BASKET HANDLE PUSH-PULL OR MONDRIAN HANDLE IN THE SAME FINISH AS THE BASKET FRONT.

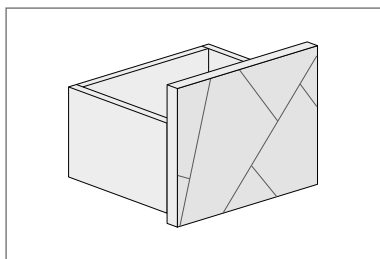

CESTONE DECORATO
DECORATED BASKET

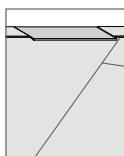

MANIGLIA MONDRIAN
MONDRIAN HANDLE

FRONTALE CESTONE DECORATO LISTELLARE IMPIALLACCIATO IN NOCE O FRASSINO SPAZZOLATO SP. CM. 2.5 E PANNELLO DECORATIVO DI MDF IMPIALLACCIATO IN NOCE O FRASSINO SPAZZOLATO SP. CM. 0.4 VERNICIATO O LACCATO A PORO APERTO.

STRUTTURA CESTONE DECORATO PANNELLO DI MULTISTRATO BETULLA SP. CM.1.5 CON INCASTRI A CODA DI RONDINE VERNICIATO TINTA ACACIA.

GUIDE CASSETTO REGOLABILI IN ALTEZZA E CON RICHIAMO AUTOMATICO AMMORTIZZATO

MANIGLIA CESTONE PUSH-PULL O MANIGLIA MONDRIAN IN FINITURA ABBIANATA AL FRONTALE CESTONE.

DECORATED BASKET FRONT BLOCKBOARD VENEERED IN WALNUT OR BRUSHED ASHWOOD TH. CM. 2.5 AND MDF DECORATIVE PANEL VENEERED IN WALNUT OR BRUSHED ASHWOOD TH. CM. 0.4 PAINTED OR OPEN PORE LACQUERED.

STRUCTURE FOR DECORATED BASKET BIRCH MULTILAYER PANEL TH. CM.1.5 WITH DOVETAIL JOINTS ACACIA STAINED PAINTED.

DRAWER GUIDES ADJUSTABLE IN HEIGHT AND SOFT-CLOSE SELF-CLOSING MECHANISM

BASKET HANDLE PUSH-PULL OR MONDRIAN HANDLE IN THE SAME FINISH AS THE BASKET FRONT.

ESEMPIO DI ELEMENTI A TERRA, IN APPOGGIO E A PARETE EXAMPLE OF FLOOR-STANDING, RAISED AND WALL ELEMENTS

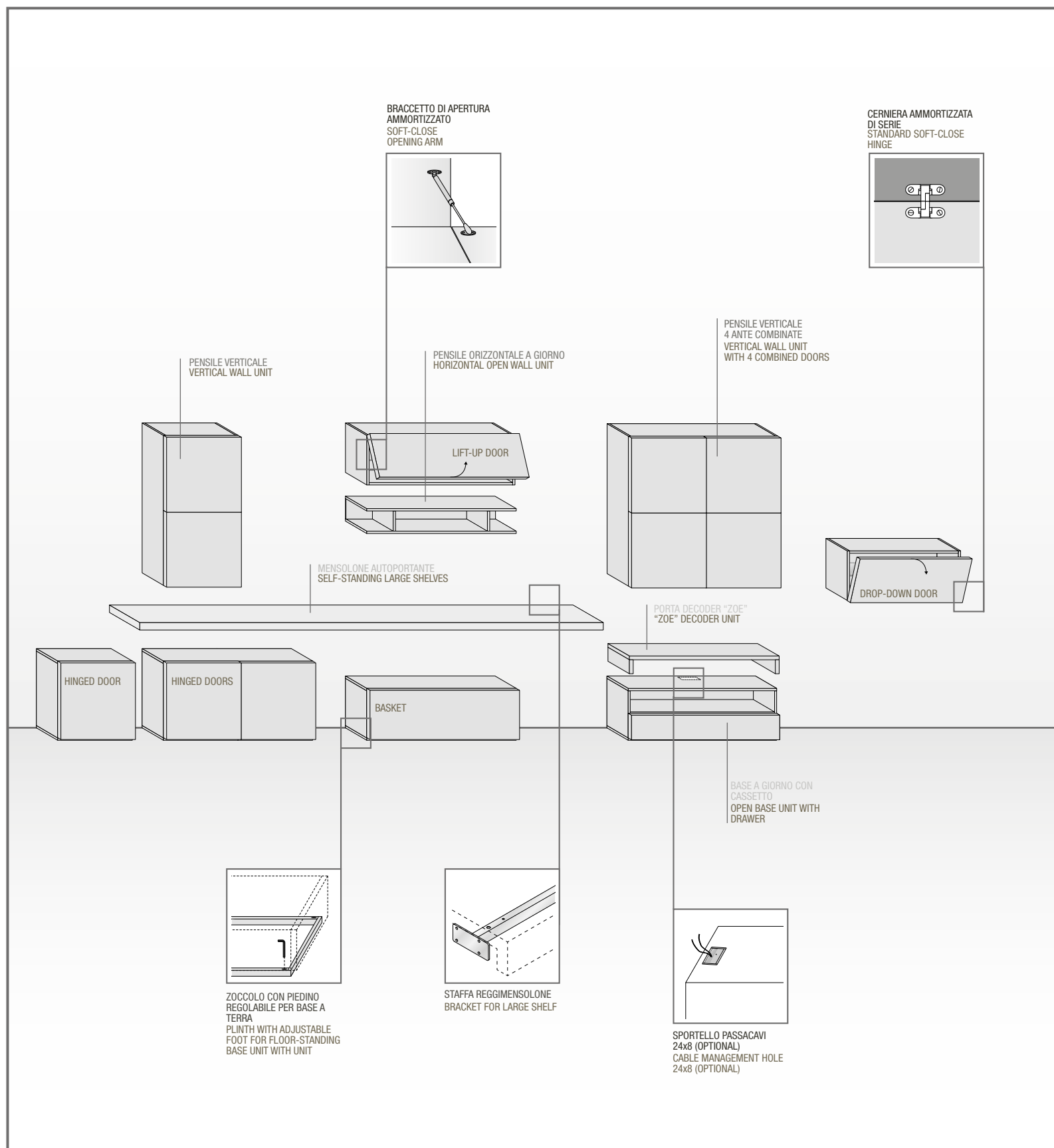

FRONTALI DECOR DECOR FRONTS

ANTE DOORS

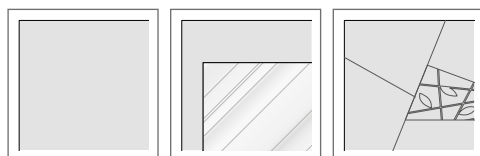

LEGNO
(BATTENTE/VASISTAS/
RIBALTA)
WOOD
(HINGED/LIFT-UP/DROP-
DOWN)

VETRO
(BATTENTE/VASISTAS/
RIBALTA)
GLASS
(HINGED/LIFT-UP/DROP-
DOWN)

DECORATO
(BATTENTE/VASISTAS/
RIBALTA)
DECORATED
(HINGED/LIFT-UP/DROP-
DOWN)

ANTA CON CORNICE PERIMETRALE DOOR WITH PERIMETRIC FRAME

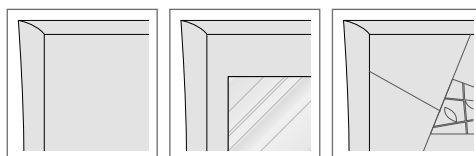

LEGNO
(BATTENTE)
WOOD
(HINGED)

VETRO
(BATTENTE)
GLASS
(HINGED)

DECORATO
(BATTENTE)
DECORATED
(HINGED)

CASSETTI DRAWERS

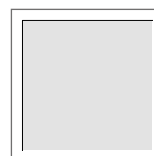

LEGNO
WOOD

CESTONI BASKETS

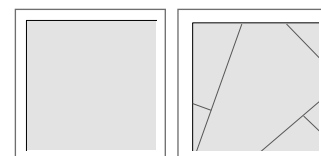

LEGNO
WOOD

DECORATO
DECORATED

DECOR SISTEMA COMPONIBILE - MODULAR SYSTEM

MODULARITÀ MODULARITY

BASI A TERRA H. 41.5 – P. 40/50

FLOOR-STANDING BASE UNIT H. 41.5 – D. 40/50

A GIORNO
OPEN

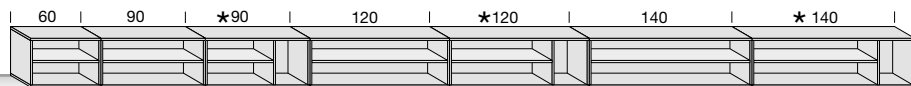

A GIORNO CON CASSETTO
OPEN WITH DRAWER

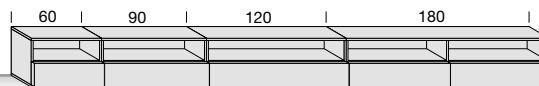

CON CASSETTI
WITH DRAWERS



CON CESTONE
WITH BASKET

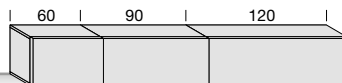

CON ANTA A RIBALTA
WITH DROP-DOWN DOOR

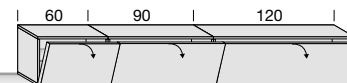

BASI A TERRA H. 41.5 – P. 40/50

FLOOR-STANDING BASE UNIT H. 41.5 – D. 40/50

CON ANTA
WITH DOOR

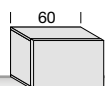

BASI A TERRA H. 61.5 – P. 40/50

FLOOR-STANDING BASE UNIT H. 61.5 – D. 40/50

CON ANTA
WITH DOOR

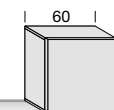

BASI SOSPESSE H. 40 – P. 40/50

SUSPENDED BASE UNITS H. 40 – D. 40/50

A GIORNO
OPEN

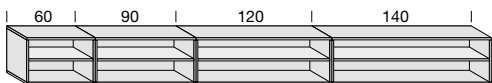

CON CESTONE
WITH BASKET

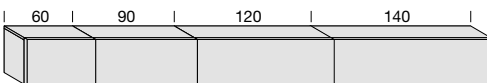

CON ANTA A RIBALTA
WITH DROP-DOWN DOOR

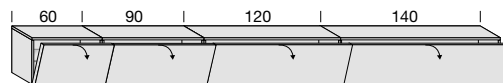

PENSILI ORIZZONTALI H. 20 – P. 40

HORIZONTAL WALL UNITS H. 20 – D. 40

A GIORNO
OPEN

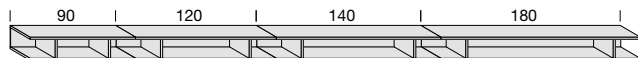

MODULARITÀ MODULARITY

■ ELEMENTI ANCHE CON CORNICE PERIMETRALE
ELEMENTS ALSO WITH PERIMETRIC FRAME

PENSILI ORIZZONTALI H. 40 – P. 40 HORIZONTAL WALL UNITS H. 40 – D. 40

A GIORNO
OPEN

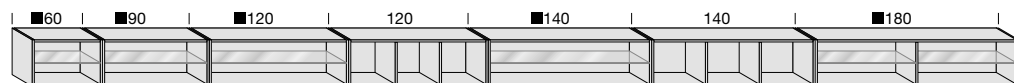

CON ANTA A RIBALTA/VASISTAS
WITH DROP-DOWN/LIFT-UP DOOR

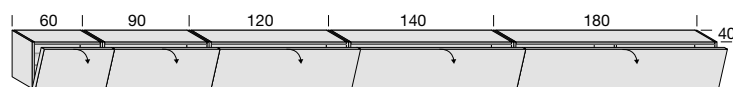

CON ANTA A RIBALTA
WITH DROP-DOWN DOOR

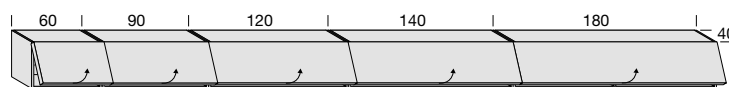

PENSILI ORIZZONTALI H. 60/64.4 – P. 40 HORIZONTAL WALL UNITS H. 60/64.4 – D. 40

A GIORNO
OPEN

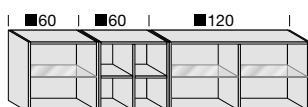

CON ANTA
WITH DOOR

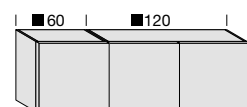

PENSILI VERTICALI H. 90/94 – P. 40/41 E H. 100 – P. 40 VERTICAL WALL UNITS H. 90/94 – D. 40/41 AND H. 100 – D. 40

A GIORNO
OPEN

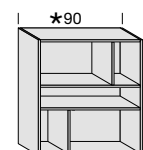

PENSILI VERTICALI H. 120/124.4 – P. 40/41 VERTICAL WALL UNITS H. 120/124.4 – D. 40/41

A GIORNO
OPEN

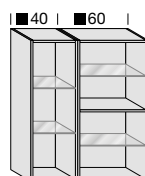

CON ANTA
WITH DOOR

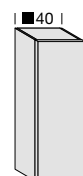

CON ANTE
WITH DOORS

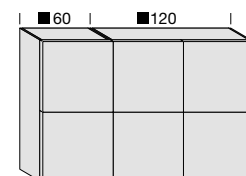

MADIE H. 63/130 – P. 40/50 CUPBOARDS H. 63 – D. 40/50

CON ANTA E CASSETTI
WITH DOOR AND DRAWERS

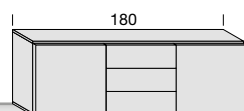

CON ANTE
WITH DOORS

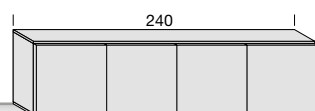

CON ANTE
WITH DOORS

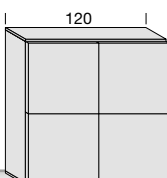

VETRINE H. 208 – P. 40 DISPLAY UNITS H. 208 – D. 40

CON ANTE
WITH DOORS

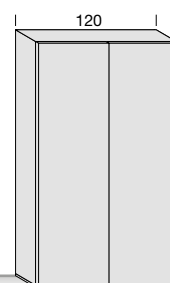

DECOR SISTEMA COMPONIBILE - MODULAR SYSTEM

CARATTERISTICHE TECNICHE E PARTICOLARITÀ DI UTILIZZO

TECHNICAL CHARACTERISTICS AND PARTICULAR USE

UTILIZZO PENSILI VASISTAS E RIBALTA

USE FOR WALL UNITS WITH LIFT-UP DOORS AND DROP-DOWN DOORS

È POSSIBILE SOVRAPPORRE DUE PENSILI VASISTAS O DUE PENSILI RIBALTA SOLO CAMBIANDO CERINERE

IT IS POSSIBLE TO STACK TWO WALL UNITS WITH LIFT-UP DOORS OR TWO WALL UNITS WITH DROP-DOWN DOORS ONLY CHANGING THE HINGES

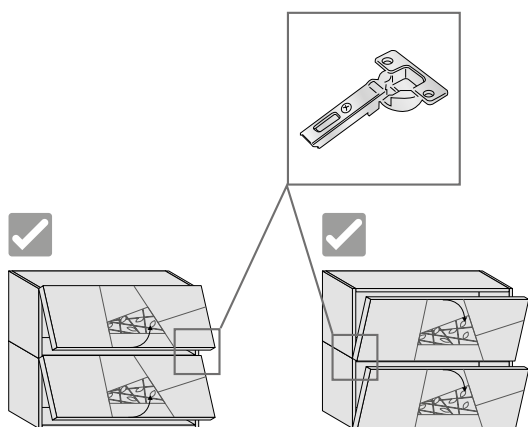

ALTEZZE MASSIME DI POSIZIONAMENTO ANTE VASISTAS/RIBALTA

MAXIMUM POSITION HEIGHTS FOR LIFT-UP/DROP-DOWN DOORS

ANTA VASISTAS LIFT-UP DOOR

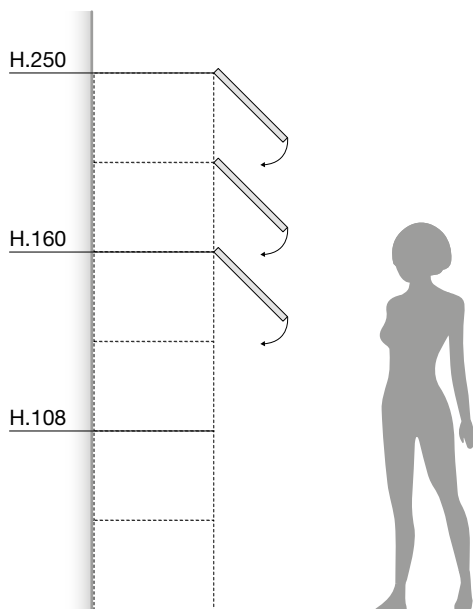

ANTA RIBALTA DROP-DOWN DOOR

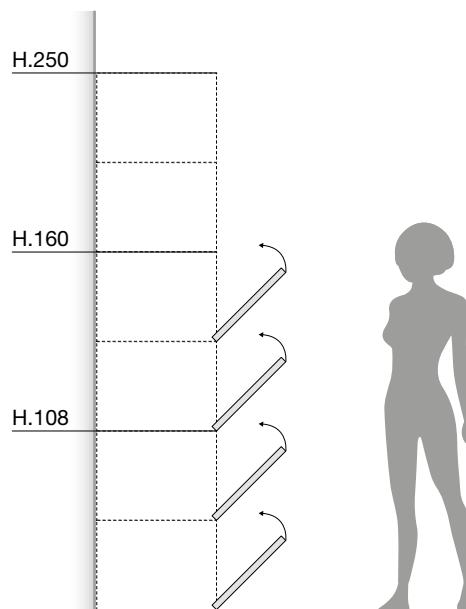

POSIZIONAMENTO ANTE A VASISTAS DA H. 160 A H. 250
POSITION OF LIFT-UP DOORS FROM H. 160 TO H. 250

POSIZIONAMENTO ANTE A RIBALTA DA H. 4.5 A H. 160
POSITION OF DROP-DOWN DOORS H. 4.5 A H. 160

CARATTERISTICHE TECNICHE E PARTICOLARITÀ DI UTILIZZO

TECHNICAL CHARACTERISTICS AND PARTICULAR USE

ALTEZZA E LARGHEZZA CESTONI

BASKETS HEIGHT AND WIDTH

FRONTALE CESTONE BASKET FRONT

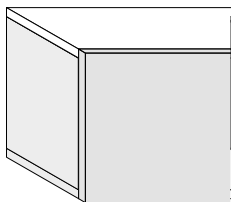

ALTEZZE CESTONI BASKET HEIGHTS

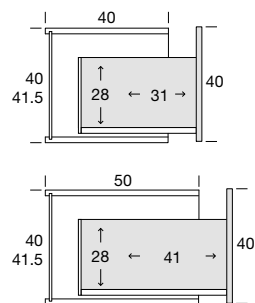

LARGHEZZE CESTONI BASKET WIDTHS

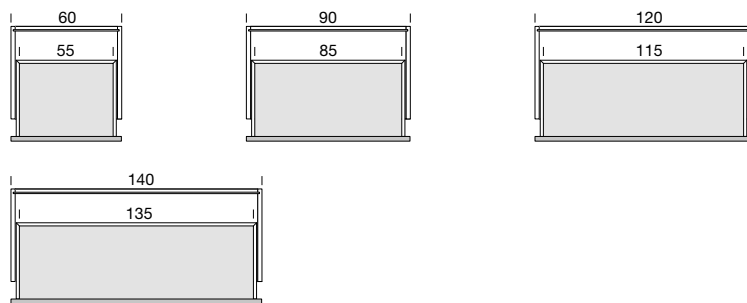

GESTIONE CORNICE PERIMETRALE

PERIMETRIC FRAME

INGOMBRI CORNICE PERIMETRALE

DIMENSIONS FOR PERIMETRIC FRAME

VISTA FRONTALE FRONT VIEW

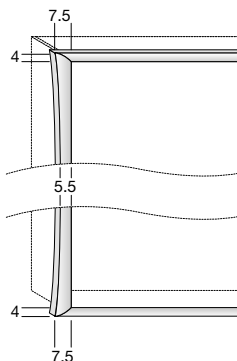

VISTA IN PIANTA LAYOUT VIEW

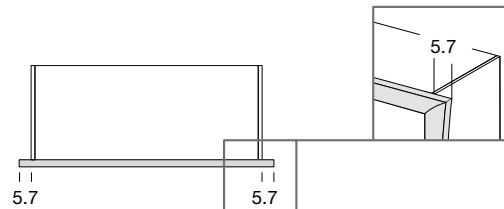

VISTA LATERALE SIDE VIEW

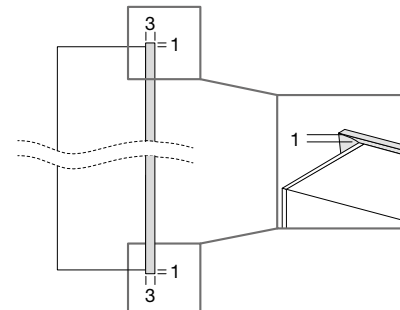

PENSILI SENZA CORNICE PERIMETRALE DECOR

WALL UNITS WITHOUT DECOR PERIMETRIC FRAME

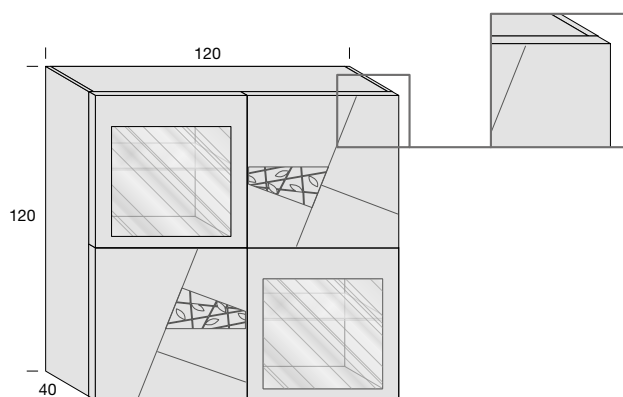

PENSILI CON CORNICE PERIMETRALE DECOR E CROCERA A VISTA

WALL UNITS WITH DECOR PERIMETRIC FRAME AND VISIBLE CROSSPIECE

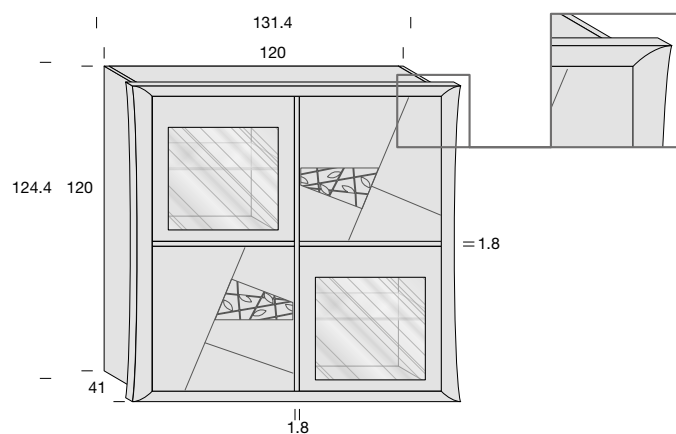

DECOR SISTEMA COMPONIBILE - MODULAR SYSTEM

ACCESSORI OPTIONAL - ELEMENTI COMUNI

OPTIONAL ACCESSORIES - COMMON ELEMENTS

BARRA LED A BASSO CONSUMO
ACCENSIONE TOUCH
IN ALLUMINIO L. 37.2
COLLEGAMENTO
A CARICO DEL CLIENTE

LOW CONSUMPTION LED BAR
TOUCH SWITCH
IN ALUMINIUM W. 37.2
CONNECTIONS
TO BE MADE BY THE CUSTOMER.



codice
code

ZZZFE22001

163

ALIMENTATORE
POWER SUPPLY



codice
code

ZZZFE22002

67

KIT SPORTELLINO PASSACAVI
+ BORCHIA
KIT FOR CABLE MANAGEMENT HOLE
+ COVER

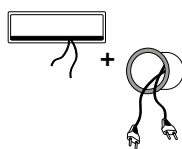

codice
code

ZZZFE22005

134

TELECOMANDO
REMOTE CONTROL



codice
code

ZZZFE22004

157

MULTIPRESA A SCOMPARSA CON
SPORTELLINO APRI/CHIUDI IN
METALLO

CONCEALED MULTIPLE SOCKET
WITH METAL OPEN/CLOSE FLAP

VERSIONE TV:
 1 PRESA SCHUKO
 2 PRESI USB RICARICA
 1 PRESA SAT.
 TV VERSION:
 1 SCHUKO SOCKET
 2 SOCKETS USB CHARGE
 1 SAT. SOCKET



codice
code

ZZZFE22030

596

VERSIONE PC/MAC:
 1 PRESA SCHUKO
 2 PORTE USB DATI
 1 PORTA HDMI
 PC/MAC VERSION:
 1 SCHUKO SOCKET
 2 USB PORT
 1 HDMI PORT



codice
code

ZZZFE22031

596

MENSOLE P. 28 – SP. 3
SHELVES D. 28 – TH. 3

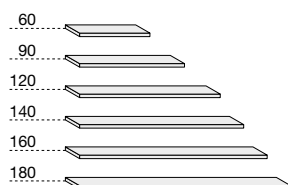

larghezza width	codice code	NOCE-FRASSINO WALNUT-ASHWOOD	
60	PFC3501K	188	mc 0,02 – Kg 2
90	PFC3511K	229	mc 0,03 – Kg 3
120	PFC3521K	271	mc 0,03 – Kg 6
140	PFC3541K	308	mc 0,04 – Kg 9
160	PFC3551K	362	mc 0,05 – Kg 9
180	PFC3531K	386	mc 0,05 – Kg 9

MENSOLONE P. 50 – SP. 6
POSIZIONABILI MAX H. 1,2 METRI.
PER AUTOPORTANTE
AGGIUNGERE STAFFE DA MURO
(+ 50,00 €)

LARGE SHELF D. 50 – TH. 6
1,2 METER MAX ADJUSTABLE.
FOR SELF-SUPPORTING
ADD WALL BRACKETS
(+ 50,00 €)

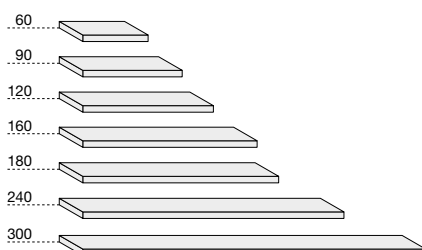

larghezza width	codice code	NOCE-FRASSINO WALNUT-ASHWOOD	
60	DCC3001K	223	mc 0,03 – Kg 3
90	DCC3011K	319	mc 0,03 – Kg 4
120	DCC3021K	415	mc 0,05 – Kg 7
160	DCC3061K	511	mc 0,06 – Kg 10
180	DCC3031K	553	mc 0,07 – Kg 10
240	DCC3041K	759	mc 0,09 – Kg 14
300	DCC3071K	890	mc 0,10 – Kg 16

PORTA DECODER ZOE
P. 40 – H. 14
ZOE DECODER UNIT
D. 40 – H. 14

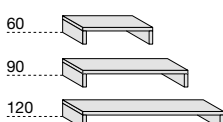

larghezza width	codice code	NOCE-FRASSINO WALNUT-ASHWOOD	
60	PFC3161K	259	mc 0,06 – Kg 7
90	PFC3111K	278	mc 0,08 – Kg 9
120	PFC3121K	332	mc 0,11 – Kg 11

ELEMENTI COMUNI COMMUN ELEMENTS

PORTA DECODER ZOE
P. 50 – H. 14
ZOE DECODER UNIT
D. 50 – H. 14

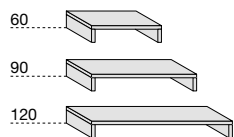

larghezza width	codice code	NOCE-FRASSINO WALNUT-ASHWOOD	
60	PFC3131K	266	mc 0,07 – Kg 7
90	PFC3141K	302	mc 0,10 – Kg 9
120	PFC3151K	350	mc 0,13 – Kg 11

**PIEDISTALLI PER
MENSOLONI P. 50 SP. 6**
**PEDESTAL FOR LARGE
SHELVES D. 50 TH. 6**

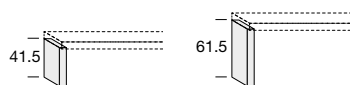

altezza height	codice code	NOCE-FRASSINO WALNUT-ASHWOOD	
41.5	DCC3511K	248	mc 0,02 – Kg 2
61.5	DCC3501K	271	mc 0,03 – Kg 3

TOP P. 40 PER BASI (OPZIONALE)
P. 40 – SP. 1.5

BASE UNITS TOP D. 40 (OPTIONAL)
D. 40 – TH. 1.5

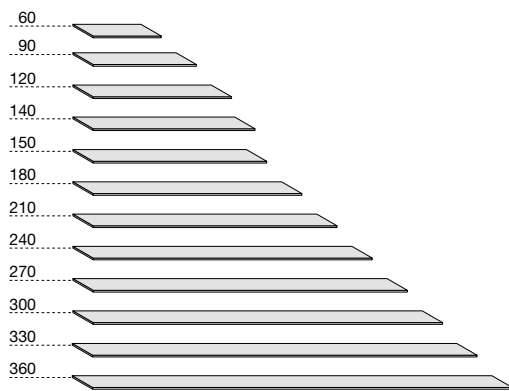

larghezza width	codice code	NOCE-FRASSINO WALNUT-ASHWOOD	
60	PFC5001C	134	mc 0,01 – Kg 3
90	PFC5011C	163	mc 0,02 – Kg 3,5
120	PFC5021C	182	mc 0,02 – Kg 4
140	PFC5221C	193	mc 0,03 – Kg 4,5
150	PFC5031C	206	mc 0,3 – Kg 6
180	PFC5041C	236	mc 0,04 – Kg 7
210	PFC5051C	266	mc 0,05 – Kg 8
240	PFC5061C	302	mc 0,05 – Kg 9
270	PFC5071C	319	mc 0,06 – Kg 9
300	PFC5081C	350	mc 0,06 – Kg 10
330	PFC5211C	391	mc 0,07 – Kg 10
360	PFC5091C	409	mc 0,07 – Kg 12

TOP P. 50 PER BASI (OPZIONALE)
P. 50 – SP. 1.5

BASE UNITS TOP D. 50 (OPTIONAL)
D. 50 – TH. 1.5

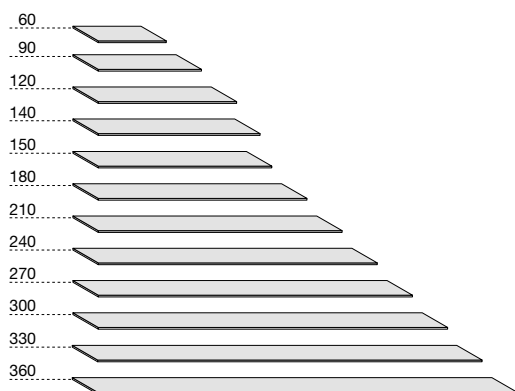

larghezza width	codice code	NOCE-FRASSINO WALNUT-ASHWOOD	
60	PFC5101C	151	mc 0,01 – Kg 3
90	PFC5111C	175	mc 0,02 – Kg 3,5
120	PFC5121C	206	mc 0,02 – Kg 4
140	PFC5231C	223	mc 0,03 – Kg 4,5
150	PFC5131C	241	mc 0,3 – Kg 6
180	PFC5141C	271	mc 0,04 – Kg 7
210	PFC5151C	302	mc 0,05 – Kg 8
240	PFC5161C	350	mc 0,05 – Kg 9
270	PFC5171C	391	mc 0,06 – Kg 9
300	PFC5181C	416	mc 0,06 – Kg 10
330	PFC5201C	464	mc 0,07 – Kg 10
360	PFC5191C	482	mc 0,07 – Kg 12

DECOR SISTEMA COMPONIBILE - MODULAR SYSTEM

BASI A TERRA P. 40

FLOOR-STANDING BASE UNIT D. 40

BASI AD ANGOLO H. 41.5 CORNER BASE UNITS H. 41.5

ANGOLO CIECO 43 x 43
BLIND CORNER BASE 43 X 43

NEW



DX / RH
SX / LH

DCC1961K

NOCE-FRASSINO / WALNUT-ASHWOOD

577

mc 0,09 – Kg 11

ANGOLO, 1 ANTA LISCIA
CORNER BASE, 1 DOOR

NEW

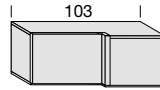

**DCC1971K
DCC1972K**

1.745

mc 0,22 – Kg 25

ANGOLO, 1 ANTA DECORATA
CORNER BASE, 1 DECORATED DOOR

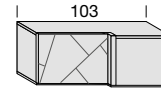

**DCC1981K
DCC1982K**

2.009

mc 0,22 – Kg 25

2 CASSETTI H. 31,5
2 DRAWERS H. 31,5

NEW

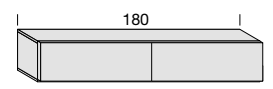

DCC1061K

1.525

mc 0,27 – Kg 53

BASI H. 41.5 BASE UNITS H. 41.5

A GIORNO, 1 RIPIANO LEGNO
OPEN, 1 WOODEN SHELF

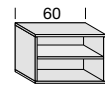

DCC1091K

NOCE-FRASSINO / WALNUT-ASHWOOD

710

mc 0,12 – Kg 12

A GIORNO, 1 CASSETTO
OPEN, 1 DRAWER

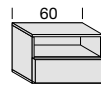

DCC1152K

1.034

mc 0,12 – Kg 17

2 CASSETTI
2 DRAWERS

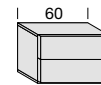

DCC1153K

1.318

mc 0,12 – Kg 18

1 CESTONE
1 BASKET

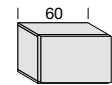

DCC1154K

909

mc 0,12 – Kg 17

1 RIBALTA DECORATA, 1 RIPIANO VETRO
1 DECORATED DROP-DOWN DOOR, 1
GLASS SHELF

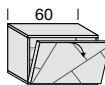

DCC3301K

NOCE-FRASSINO / WALNUT-ASHWOOD

1.011

mc 0,12 – Kg 16

A GIORNO, 1 RIPIANO LEGNO
OPEN, 1 WOODEN SHELF

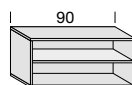

DCC1111K

823

mc 0,18 – Kg 18

A GIORNO, 1 RIPIANO LEGNO
E DIVISORIO
OPEN, 1 WOODEN SHELF
AND PARTITION

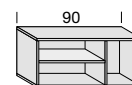

DCC1331K

879

mc 0,18 – Kg 19

A GIORNO, 1 CASSETTO
OPEN, 1 DRAWER

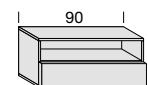

DCC1362K

1.136

mc 0,18 – Kg 26

1 RIBALTA DECORATA, 1 RIPIANO VETRO
1 DECORATED DROP-DOWN DOOR, 1
GLASS SHELF

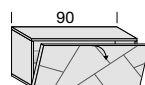

DCC3311K

NOCE-FRASSINO / WALNUT-ASHWOOD

1.245

mc 0,18 – Kg 24

A GIORNO, 1 RIPIANO LEGNO
OPEN, 1 WOODEN SHELF

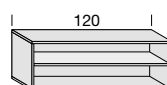

DCC1131K

986

mc 0,24 – Kg 25

A GIORNO, 1 RIPIANO LEGNO
E DIVISORIO
OPEN, 1 WOODEN SHELF
AND PARTITION

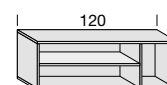

DCC1351K

1.052

mc 0,24 – Kg 26

A GIORNO, 1 CASSETTO
OPEN, 1 DRAWER

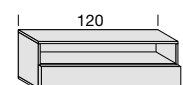

DCC1382K

1.240

mc 0,24 – Kg 34

OPTIONAL OPTIONAL

KIT SPORTELLINO PASSACAVI
+ BORCHIA
KIT FOR CABLE MANAGEMENT HOLE
+ COVER

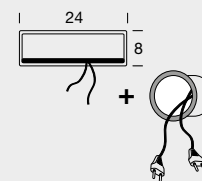

ZZZFE22005

133

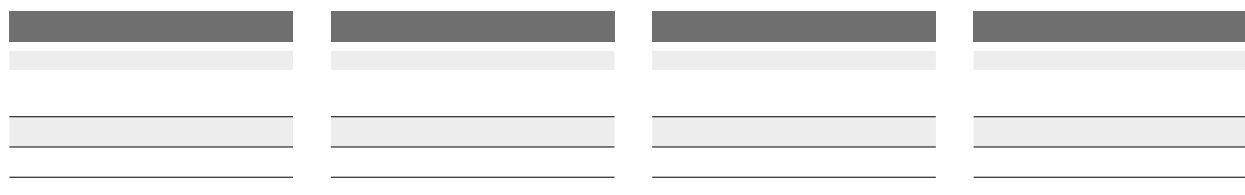

1 CESTONE DECORATO
1 DECORATED BASKET

1 ANTA LEGNO, 1 RIPIANO VETRO
1 WOODEN DOOR, 1 GLASS SHELF

1 ANTA DECORATA, 1 RIPIANO VETRO
1 DECORATED DOOR, 1 GLASS SHELF

1 RIBALTA, 1 RIPIANO VETRO
1 DROP-DOWN DOOR, 1 GLASS SHELF

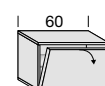
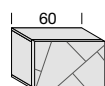
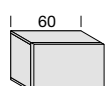
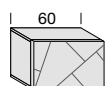

DCC1151K

DCC1921K
DCC1931K

DCC1922K
DCC1932K

DCC3302K

1.011

823

920

909

mc 0,12 - Kg 17

mc 0,12 - Kg 15

mc 0,12 - Kg 15

mc 0,12 - Kg 16

2 CASSETTI
2 DRAWERS

1 CESTONE
1 BASKET

1 CESTONE DECORATO
1 DECORATED BASKET

1 RIBALTA, 1 RIPIANO VETRO
1 DROP-DOWN DOOR, 1 GLASS SHELF

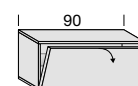
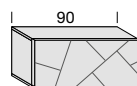
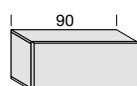
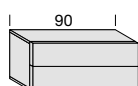

DCC1173K

DCC1174K

DCC1171K

DCC3312K

1.425

1.130

1.245

1.130

mc 0,18 - Kg 27

mc 0,18 - Kg 25

mc 0,18 - Kg 25

mc 0,18 - Kg 24

2 CASSETTI
2 DRAWERS

1 CESTONE
1 BASKET

1 CESTONE DECORATO
1 DECORATED BASKET

1 RIBALTA, 1 RIPIANO VETRO
1 DROP-DOWN DOOR, 1 GLASS SHELF

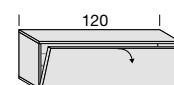
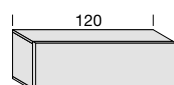
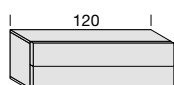

DCC1383K

DCC1384K

DCC1191K

DCC3322K

1.521

1.323

1.527

1.323

mc 0,24 - Kg 35

mc 0,24 - Kg 33

mc 0,24 - Kg 33

mc 0,24 - Kg 32

POSSIBILITÀ DI FRONTALE DIVERSO
DALLA SCOCCA, SPECIFICARE LA
FINITURA SCELTA

IN CASE OF FRONT DIFFERENT FROM
THE CARCASE CONSIDER THE
HIGHER PRICE OF THE CHOSEN
FINISH

DECOR SISTEMA COMPONIBILE - MODULAR SYSTEM

BASI A TERRA P. 40

FLOOR-STANDING BASE UNIT D. 40

BASI H. 41.5

BASE UNITS H. 41.5

1 RIBALTA DECORATA, 1 RIPIANO VETRO
1 DECORATED DROP-DOWN DOOR, 1
GLASS SHELF

A GIORNO, 1 RIPIANO LEGNO
OPEN, 1 WOODEN SHELF

A GIORNO, 1 RIPIANO LEGNO
E DIVISORIO
OPEN, 1 WOODEN SHELF
AND PARTITION

A GIORNO, 1 CASSETTO
OPEN, 1 DRAWER

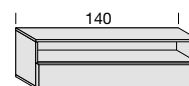
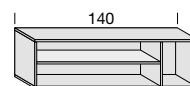
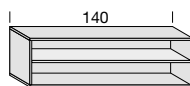
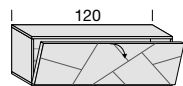

DCC3321K

DCC1134K

DCC1354K

DCC1204K

NOCE-FRASSINO / WALNUT-ASHWOOD

1.527

1.270

1.323

1.504

mc 0,24 – Kg 32

mc 0,28 – Kg 28

mc 0,28 – Kg 29

mc 0,28 – Kg 40

1 RIBALTA DECORATA, 1 RIPIANO VETRO
1 DECORATED DROP-DOWN DOOR, 1
GLASS SHELF

A GIORNO, 2 CASSETTI
OPEN, 2 DRAWERS

4 CASSETTI
4 DRAWERS

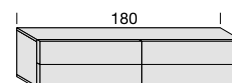
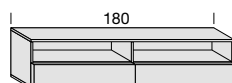

DCC3334K

DCC3192K

DCC3193K

NOCE-FRASSINO / WALNUT-ASHWOOD

1.798

1.816

2.153

mc 0,28 – Kg 38

mc 0,36 – Kg 52

mc 0,36 – Kg 54

BASI H. 61.5

BASE UNITS H. 61.5

1 ANTA LEGNO, 1 RIPIANO VETRO
1 WOODEN DOOR, 1 GLASS SHELF

1 ANTA DECORATA, 1 RIPIANO VETRO
1 DECORATED DOOR, 1 GLASS SHELF

1 ANTA DECORATA, 1 RIPIANO VETRO
1 DECORATED DOOR, 1 GLASS SHELF

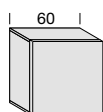

*

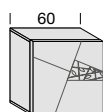

*

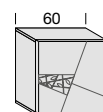

DX / RH
SX / LH

DCC3231K
DCC3232K

DCC3131K-SX

DCC3531K-DX

NOCE-FRASSINO / WALNUT-ASHWOOD

975

1.136

1.136

mc 0,18 – Kg 23

mc 0,18 – Kg 23

mc 0,18 – Kg 23

2 CASSETTI
2 DRAWERS

1 CESTONE
1 BASKET

1 CESTONE DECORATO
1 DECORATED BASKET

1 RIBALTA, 1 RIPIANO VETRO
1 DROP-DOWN DOOR, 1 GLASS SHELF

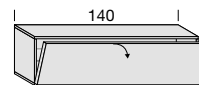
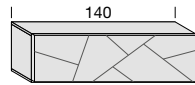
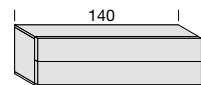

DCC1214K

DCC1224K

DCC1194K

DCC3324K

1.780

1.593

1.798

1.593

mc 0,28 - Kg 41

mc 0,28 - Kg 39

mc 0,28 - Kg 39

mc 0,28 - Kg 38

OPTIONAL
OPTIONAL

KIT SPORTELLINO PASSACAVI
+ BORCHIA
KIT FOR CABLE MANAGEMENT HOLE
+ COVER

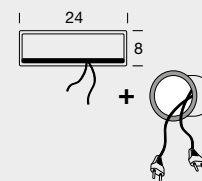

ZZZFE22005

133

*
SPECIFICARE CON O SENZA
DECORO FOGLIA
(IL PREZZO È LO STESSO)
PLEASE SPECIFY WITH OR WITHOUT
LEAF DECORATION
(THE PRICE IS THE SAME)

POSSIBILITÀ DI FRONTALE DIVERSO
DALLA SCOCCA, SPECIFICARE LA
FINITURA SCELTA

IN CASE OF FRONT DIFFERENT FROM
THE CARCASE CONSIDER THE
HIGHER PRICE OF THE CHOSEN
FINISH

DECOR SISTEMA COMPONIBILE - MODULAR SYSTEM

BASI A TERRA P. 50

FLOOR-STANDING BASE UNIT D. 50

BASI AD ANGOLO H. 41.5 CORNER BASE UNITS H. 41.5

ANGOLO CIECO 53 x 53
BLIND CORNER BASE 53 X 53

NEW



DX / RH
SX / LH

DCC1963K

NOCE-FRASSINO / WALNUT-ASHWOOD

625

mc 0,14 – Kg 12

ANGOLO, 1 ANTA LISCIA
CORNER BASE, 1 DOOR

NEW



**DCC1973K
DCC1974K**

1.793

mc 0,30 – Kg 26

ANGOLO, 1 ANTA DECORATA
CORNER BASE, 1 DECORATED DOOR

NEW

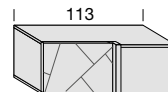

**DCC1983K
DCC1984K**

2.068

mc 0,30 – Kg 26

2 CASSETTI H. 31,5
2 DRAWERS H. 31,5

NEW

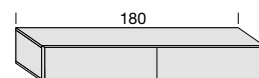

DCC1651K

1.585

mc 0,35 – Kg 53

BASI H. 41.5 BASE UNITS H. 41.5

A GIORNO, 1 RIPIANO LEGNO
OPEN, 1 WOODEN SHELF

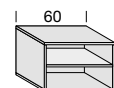

DX / RH
SX / LH

DCC1081K

NOCE-FRASSINO / WALNUT-ASHWOOD

735

mc 0,15 – Kg 15

A GIORNO, 1 CASSETTO
OPEN, 1 DRAWER

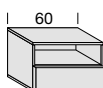

DCC1142K

1.059

mc 0,15 – Kg 22

2 CASSETTI
2 DRAWERS

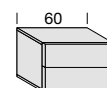

DCC1143K

1.353

mc 0,15 – Kg 23

1 CESTONE
1 BASKET

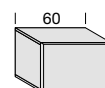

DCC1144K

932

mc 0,15 – Kg 22

1 RIBALTA DECORATA, 1 RIPIANO VETRO
1 DECORATED DROP-DOWN DOOR, 1
GLASS SHELF

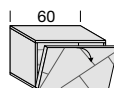

DCC3101K

NOCE-FRASSINO / WALNUT-ASHWOOD

1.041

mc 0,15 – Kg 20

A GIORNO, 1 RIPIANO LEGNO
OPEN, 1 WOODEN SHELF

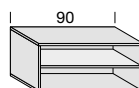

DCC1101K

848

mc 0,22 – Kg 23

A GIORNO, 1 RIPIANO LEGNO
E DIVISORIO
OPEN, 1 WOODEN SHELF
AND PARTITION

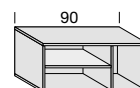

DCC1231K

903

mc 0,22 – Kg 24

A GIORNO, 1 CASSETTO
OPEN, 1 DRAWER

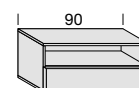

DCC1162K

1.167

mc 0,22 – Kg 33

1 RIBALTA DECORATA, 1 RIPIANO VETRO
1 DECORATED DROP-DOWN DOOR, 1
GLASS SHELF

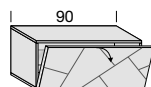

DCC3111K

NOCE-FRASSINO / WALNUT-ASHWOOD

1.288

mc 0,22 – Kg 30

A GIORNO, 1 RIPIANO LEGNO
OPEN, 1 WOODEN SHELF

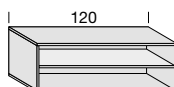

DCC1121K

1.023

mc 0,29 – Kg 32

A GIORNO, 1 RIPIANO LEGNO
E DIVISORIO
OPEN, 1 WOODEN SHELF
AND PARTITION

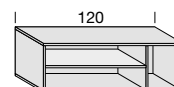

DCC1251K

1.089

mc 0,29 – Kg 33

A GIORNO, 1 CASSETTO
OPEN, 1 DRAWER

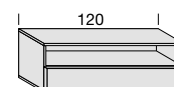

DCC1182K

1.275

mc 0,29 – Kg 42

OPTIONAL OPTIONAL

KIT SPORTELLINO PASSACAVI
+ BORCHIA
KIT FOR CABLE MANAGEMENT HOLE
+ COVER

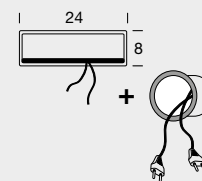

ZZZFE22005

133

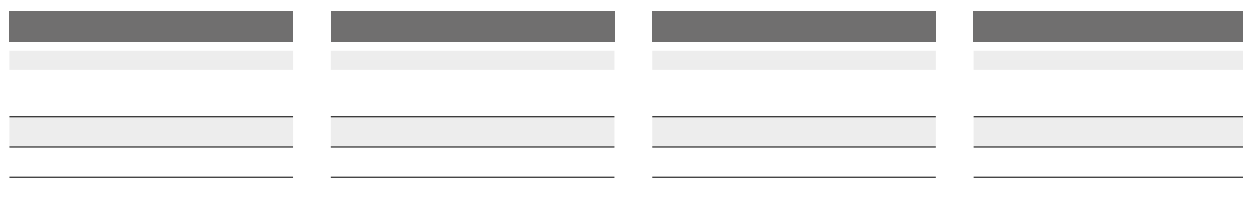

1 CESTONE DECORATO
1 DECORATED BASKET

1 ANTA LEGNO, 1 RIPIANO VETRO
1 WOODEN DOOR, 1 GLASS SHELF

1 ANTA DECORATA, 1 RIPIANO VETRO
1 DECORATED DOOR, 1 GLASS SHELF

1 RIBALTA, 1 RIPIANO VETRO
1 DROP-DOWN DOOR, 1 GLASS SHELF

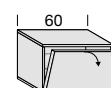
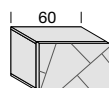
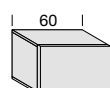
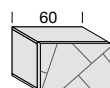

DCC1141K

DCC1941K
DCC1951K

DCC1942K
DCC1952K

DCC3102K

1.041

831

951

932

mc 0,15 - Kg 22

mc 0,15 - Kg 20

mc 0,15 - Kg 20

mc 0,15 - Kg 20

2 CASSETTI
2 DRAWERS

1 CESTONE
1 BASKET

1 CESTONE DECORATO
1 DECORATED BASKET

1 RIBALTA, 1 RIPIANO VETRO
1 DROP-DOWN DOOR, 1 GLASS SHELF

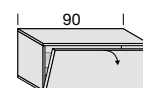
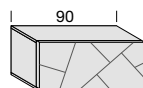
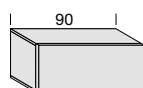
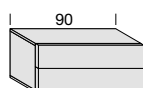

DCC1163K

DCC1164K

DCC1161K

DCC3112K

1.467

1.160

1.288

1.160

mc 0,22 - Kg 34

mc 0,22 - Kg 32

mc 0,22 - Kg 32

mc 0,22 - Kg 30

2 CASSETTI
2 DRAWERS

1 CESTONE
1 BASKET

1 CESTONE DECORATO
1 DECORATED BASKET

1 RIBALTA, 1 RIPIANO VETRO
1 DROP-DOWN DOOR, 1 GLASS SHELF

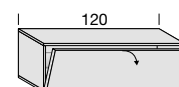
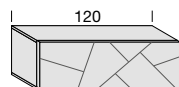
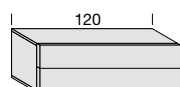

DCC1183K

DCC1184K

DCC1181K

DCC3122K

1.564

1.365

1.569

1.365

mc 0,29 - Kg 43

mc 0,29 - Kg 41

mc 0,29 - Kg 41

mc 0,29 - Kg 40

POSSIBILITÀ DI FRONTALE DIVERSO
DALLA SCOCCA, SPECIFICARE LA
FINITURA SCELTA

IN CASE OF FRONT DIFFERENT FROM
THE CARCASE CONSIDER THE
HIGHER PRICE OF THE CHOSEN
FINISH

DECOR SISTEMA COMPONIBILE - MODULAR SYSTEM

BASI A TERRA P. 50

FLOOR-STANDING BASE UNIT D. 50

BASI H. 41.5

BASE UNITS H. 41.5

1 RIBALTA DECORATA, 1 RIPIANO VETRO
1 DECORATED DROP-DOWN DOOR, 1
GLASS SHELF

A GIORNO, 1 RIPIANO LEGNO
OPEN, 1 WOODEN SHELF

A GIORNO, 1 RIPIANO LEGNO
E DIVISORIO
OPEN, 1 WOODEN SHELF
AND PARTITION

A GIORNO, 1 CASSETTO
OPEN, 1 DRAWER

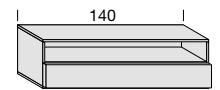
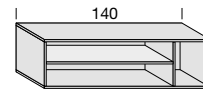
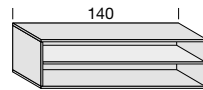
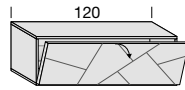

DCC3121K

DCC1124K

DCC1254K

DCC1234K

NOCE-FRASSINO / WALNUT-ASHWOOD

1.569

1.341

1.377

1.557

mc 0,29 – Kg 40

mc 0,35 – Kg 35

mc 0,35 – Kg 36

mc 0,35 – Kg 50

1 RIBALTA DECORATA, 1 RIPIANO VETRO
1 DECORATED DROP-DOWN DOOR, 1
GLASS SHELF

A GIORNO, 2 CASSETTI
OPEN, 2 DRAWERS

4 CASSETTI
4 DRAWERS

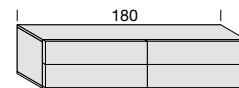
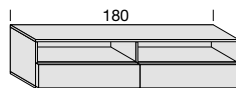
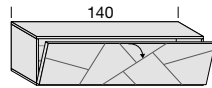

DCC3134K

DCC1192K

DCC1193K

NOCE-FRASSINO / WALNUT-ASHWOOD

1.852

1.858

2.212

mc 0,35 – Kg 48

mc 0,44 – Kg 65

mc 0,44 – Kg 68

BASI H. 61.5

BASE UNITS H. 61.5

1 ANTA LEGNO, 1 RIPIANO VETRO
1 WOODEN DOOR, 1 GLASS SHELF

1 ANTA DECORATA, 1 RIPIANO VETRO
1 DECORATED DOOR, 1 GLASS SHELF

1 ANTA DECORATA, 1 RIPIANO VETRO
1 DECORATED DOOR, 1 GLASS SHELF

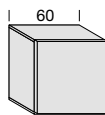

*

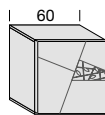

*

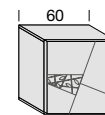

DX / RH
SX / LH

DCC3331K
DCC3332K

DCC3341K-SX

DCC3741K-DX

NOCE-FRASSINO / WALNUT-ASHWOOD

1.004

1.167

1.167

mc 0,22 – Kg 29

mc 0,22 – Kg 29

mc 0,22 – Kg 29

2 CASSETTI
2 DRAWERS

1 CESTONE
1 BASKET

1 CESTONE DECORATO
1 DECORATED BASKET

1 RIBALTA, 1 RIPIANO VETRO
1 DROP-DOWN DOOR, 1 GLASS SHELF

OPTIONAL
OPTIONAL

**KIT SPORTELLINO PASSACAVI
+ BORCHIA**
KIT FOR CABLE MANAGEMENT HOLE
+ COVER

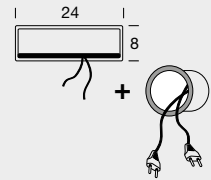

ZZZFE22005

133

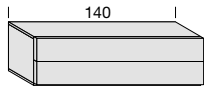

DCC1244K

1.833

mc 0,35 – Kg 52



DCC1284K

1.648

mc 0,35 – Kg 49

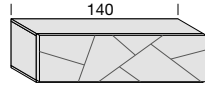

DCC1484K

1.852

mc 0,35 – Kg 49

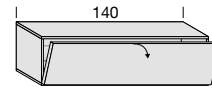

DCC3124K

1.659

mc 0,35 – Kg 48

SPECIFICARE CON O SENZA
DECORO FOGLIA
(IL PREZZO È LO STESSO)
PLEASE SPECIFY WITH OR WITHOUT
LEAF DECORATION
(THE PRICE IS THE SAME)

POSSIBILITÀ DI FRONTALE DIVERSO
DALLA SCOCCA, SPECIFICARE LA
FINITURA SCELTA

IN CASE OF FRONT DIFFERENT FROM
THE CARCASE CONSIDER THE
HIGHER PRICE OF THE CHOSEN
FINISH

DECOR SISTEMA COMPONIBILE - MODULAR SYSTEM

BASI SOSPESSE P. 40

SUSPENDED BASE UNITS D. 40

BASI AD ANGOLO H. 40 CORNER BASE UNITS H. 40

ANGOLO CIECO 43 x 43
BLIND CORNER BASE 43 X 43

NEW



DX / RH
SX / LH

DCC1965K

ANGOLO, 1 ANTA LISCIA
CORNER BASE, 1 DOOR

NEW

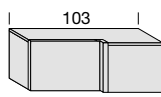

**DCC1975K
DCC1976K**

ANGOLO, 1 ANTA DECORATA
CORNER BASE, 1 DECORATED DOOR

NEW

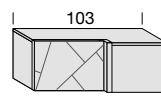

**DCC1985K
DCC1986K**

NOCE-FRASSINO / WALNUT-ASHWOOD

577

mc 0,09 – Kg 11

1.745

mc 0,22 – Kg 25

2.009

mc 0,22 – Kg 25

BASI H. 40 BASE UNITS H. 40

A GIORNO, 1 RIPIANO LEGNO
OPEN, 1 WOODEN SHELF

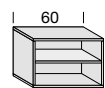

DCC1341K

1 CESTONE
1 BASKET

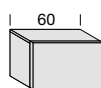

DCC1404K

1 CESTONE DECORATO
1 DECORATED BASKET

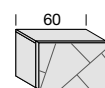

DCC1401K

1 RIBALTA LEGNO, 1 RIPIANO VETRO
1 WOODEN DROP-DOWN DOOR, 1 GLASS SHELF

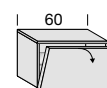

DCC1402K

NOCE-FRASSINO / WALNUT-ASHWOOD

710

mc 0,12 – Kg 12

909

mc 0,12 – Kg 17

1.011

mc 0,12 – Kg 17

909

mc 0,12 – Kg 16

1 RIBALTA LEGNO, 1 RIPIANO VETRO
1 WOODEN DROP-DOWN DOOR, 1 GLASS SHELF

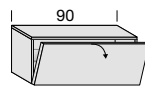

DCC1422K

1 RIBALTA DECORATA, 1 RIPIANO VETRO
1 DECORATED DROP-DOWN DOOR, 1 GLASS SHELF

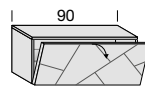

DCC1423K

A GIORNO, 1 RIPIANO LEGNO
OPEN, 1 WOODEN SHELF



DCC1381K

1 CESTONE
1 BASKET

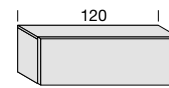

DCC1444K

NOCE-FRASSINO / WALNUT-ASHWOOD

1.130

mc 0,18 – Kg 24

1.245

mc 0,18 – Kg 24

986

mc 0,24 – Kg 25

1.323

mc 0,24 – Kg 33

1 CESTONE
1 BASKET

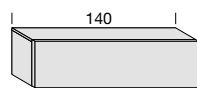

DCC1464K

1 CESTONE DECORATO
1 DECORATED BASKET

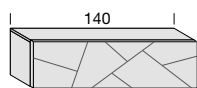

DCC1474K

1 RIBALTA LEGNO, 1 RIPIANO VETRO
1 WOODEN DROP-DOWN DOOR, 1 GLASS SHELF

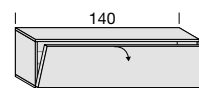

DCC1504K

1 RIBALTA DECORATA, 1 RIPIANO VETRO
1 DECORATED DROP-DOWN DOOR, 1 GLASS SHELF

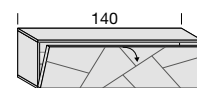

DCC1514K

NOCE-FRASSINO / WALNUT-ASHWOOD

1.593

mc 0,28 – Kg 39

1.798

mc 0,28 – Kg 39

1.593

mc 0,28 – Kg 38

1.798

mc 0,28 – Kg 38

**OPTIONAL
OPTIONAL**

**KIT SPORTELLINO PASSACAVI
+ BORCHIA**
KIT FOR CABLE MANAGEMENT HOLE
+ COVER

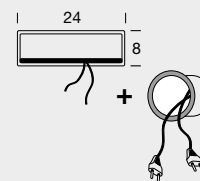

ZZZFE22005

133

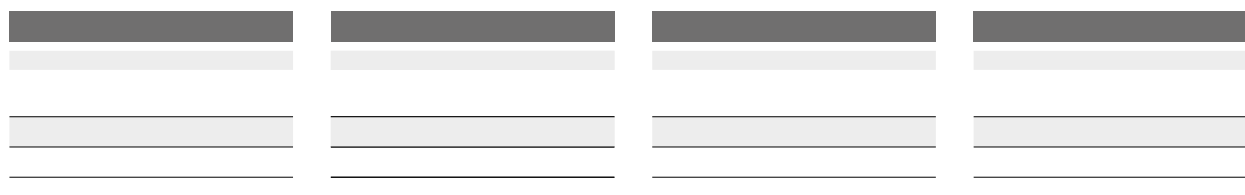

1 RIBALTA DECORATA, 1 RIPIANO VETRO
1 DECORATED DROP-DOWN DOOR, 1
GLASS SHELF

A GIORNO, 1 RIPIANO LEGNO
OPEN, 1 WOODEN SHELF

1 CESTONE
1 BASKET

1 CESTONE DECORATO
1 DECORATED BASKET

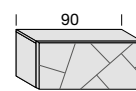
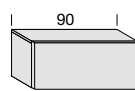
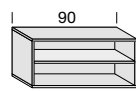
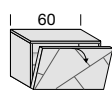

DCC1403K

DCC1361K

DCC1424K

DCC1421K

1.011

823

1.130

1.245

mc 0,12 – Kg 16

mc 0,18 – Kg 18

mc 0,18 – Kg 25

mc 0,18 – Kg 25

1 CESTONE DECORATO
1 DECORATED BASKET

1 RIBALTA LEGNO, 1 RIPIANO VETRO
1 WOODEN DROP-DOWN DOOR, 1 GLASS
SHELF

1 RIBALTA DECORATA, 1 RIPIANO VETRO
1 DECORATED DROP-DOWN DOOR, 1
GLASS SHELF

A GIORNO, 1 RIPIANO LEGNO
OPEN, 1 WOODEN SHELF

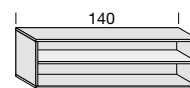
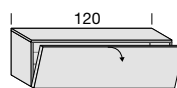
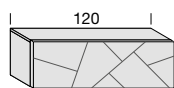

DCC1441K

DCC1442K

DCC1443K

DCC1364K

1.527

1.323

1.527

1.270

mc 0,24 – Kg 33

mc 0,24 – Kg 32

mc 0,24 – Kg 32

mc 0,28 – Kg 28

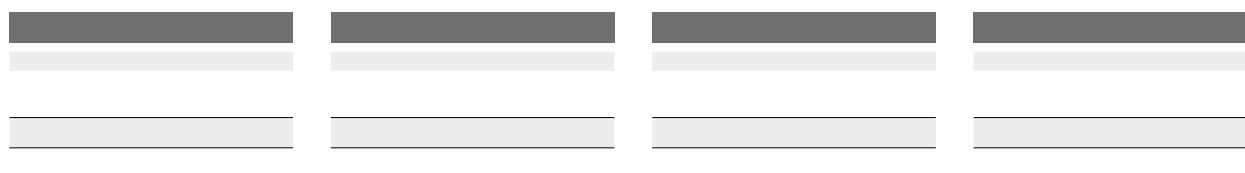

**POSSIBILITÀ DI FRONTALE DIVERSO
DALLA SCOCCA, SPECIFICARE LA
FINITURA SCELTA**

IN CASE OF FRONT DIFFERENT FROM
THE CARCASE CONSIDER THE
HIGHER PRICE OF THE CHOSEN
FINISH

DECOR SISTEMA COMPONIBILE - MODULAR SYSTEM

BASI SOSPESSE P. 50

SUSPENDED BASE UNITS D. 50

BASI AD ANGOLO H. 40 CORNER BASE UNITS H. 40

ANGOLO CIECO 53 x 53
BLIND CORNER BASE 53 X 53

NEW

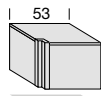

DX / RH
SX / LH

DCC1967K

ANGOLO, 1 ANTA LISCIA
CORNER BASE, 1 DOOR

NEW

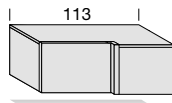

**DCC1977K
DCC1978K**

ANGOLO, 1 ANTA DECORATA
CORNER BASE, 1 DECORATED DOOR

NEW

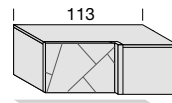

**DCC1987K
DCC1988K**

NOCE-FRASSINO / WALNUT-ASHWOOD

625

mc 0,14 – Kg 12

1.793

mc 0,30 – Kg 26

2.068

mc 0,30 – Kg 26

BASI H. 40 BASE UNITS H. 40

A GIORNO, 1 RIPIANO LEGNO
OPEN, 1 WOODEN SHELF

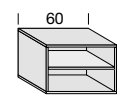

DCC1471K

1 CESTONE
1 BASKET

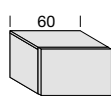

DCC1414K

1 CESTONE DECORATO
1 DECORATED BASKET

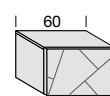

DCC1411K

1 RIBALTA LEGNO, 1 RIPIANO VETRO
1 WOODEN DROP-DOWN DOOR, 1 GLASS SHELF

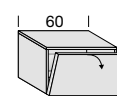

DCC1412K

NOCE-FRASSINO / WALNUT-ASHWOOD

735

mc 0,15 – Kg 15

932

mc 0,15 – Kg 22

1.041

mc 0,15 – Kg 22

932

mc 0,15 – Kg 20

1 RIBALTA LEGNO, 1 RIPIANO VETRO
1 WOODEN DROP-DOWN DOOR, 1 GLASS SHELF

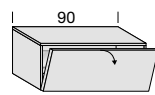

DCC1432K

1 RIBALTA DECORATA, 1 RIPIANO VETRO
1 DECORATED DROP-DOWN DOOR, 1 GLASS SHELF

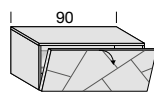

DCC1433K

A GIORNO, 1 RIPIANO LEGNO
OPEN, 1 WOODEN SHELF

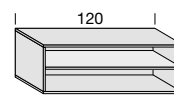

DCC1391K

1 CESTONE
1 BASKET

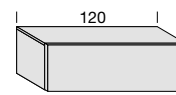

DCC1454K

NOCE-FRASSINO / WALNUT-ASHWOOD

1.160

mc 0,22 – Kg 30

1.359

mc 0,22 – Kg 30

1.023

mc 0,29 – Kg 32

1.365

mc 0,29 – Kg 41

1 CESTONE
1 BASKET

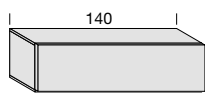

DCC1524K

1 CESTONE DECORATO
1 DECORATED BASKET

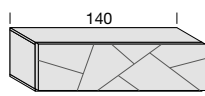

DCC1534K

1 RIBALTA LEGNO, 1 RIPIANO VETRO
1 WOODEN DROP-DOWN DOOR, 1 GLASS SHELF

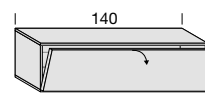

DCC1544K

1 RIBALTA DECORATA, 1 RIPIANO VETRO
1 DECORATED DROP-DOWN DOOR, 1 GLASS SHELF

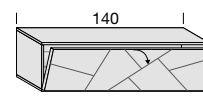

DCC1554K

NOCE-FRASSINO / WALNUT-ASHWOOD

1.648

mc 0,35 – Kg 49

1.852

mc 0,35 – Kg 49

1.659

mc 0,35 – Kg 48

1.852

mc 0,35 – Kg 48

OPTIONAL
OPTIONAL

**KIT SPORTELO PASSACAVI
+ BORCHIA**
KIT FOR CABLE MANAGEMENT HOLE
+ COVER

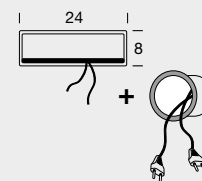

ZZZFE22005

133

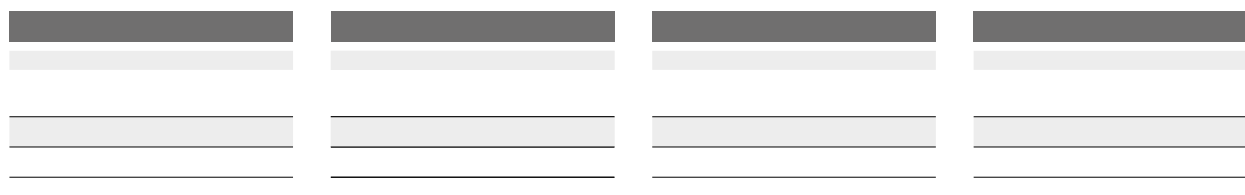

1 RIBALTA DECORATA, 1 RIPIANO VETRO
1 DECORATED DROP-DOWN DOOR, 1
GLASS SHELF

A GIORNO, 1 RIPIANO LEGNO
OPEN, 1 WOODEN SHELF

1 CESTONE
1 BASKET

1 CESTONE DECORATO
1 DECORATED BASKET

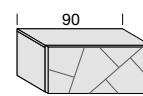
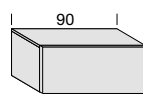
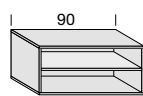
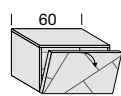

DCC1413K

DCC1371K

DCC1434K

DCC1431K

1.041

848

1.160

1.288

mc 0,15 – Kg 20

mc 0,22 – Kg 23

mc 0,22 – Kg 32

mc 0,22 – Kg 32

1 CESTONE DECORATO
1 DECORATED BASKET

1 RIBALTA LEGNO, 1 RIPIANO VETRO
1 WOODEN DROP-DOWN DOOR, 1 GLASS
SHELF

1 RIBALTA DECORATA, 1 RIPIANO VETRO
1 DECORATED DROP-DOWN DOOR, 1
GLASS SHELF

A GIORNO, 1 RIPIANO LEGNO
OPEN, 1 WOODEN SHELF

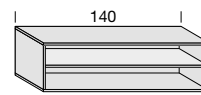
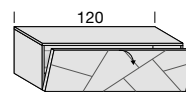
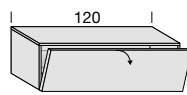
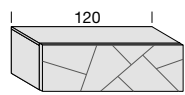

DCC1451K

DCC1452K

DCC1453K

DCC1394K

1.569

1.365

1.569

1.341

mc 0,29 – Kg 41

mc 0,29 – Kg 40

mc 0,29 – Kg 40

mc 0,35 – Kg 35

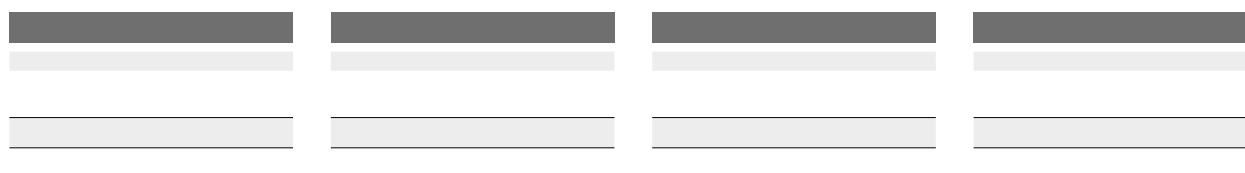

**POSSIBILITÀ DI FRONTALE DIVERSO
DALLA SCOCCA, SPECIFICARE LA
FINITURA SCELTA**

IN CASE OF FRONT DIFFERENT FROM
THE CARCASE CONSIDER THE
HIGHER PRICE OF THE CHOSEN
FINISH

DECOR SISTEMA COMPONIBILE - MODULAR SYSTEM

PENSILI ORIZZONTALI P. 40

HORIZONTAL WALL UNITS D. 40

PENSILI H. 20 WALL UNITS H. 20

A GIORNO CON 3 VANI
OPEN WITH 3 COMPARTMENTS

A GIORNO CON 3 VANI
OPEN WITH 3 COMPARTMENTS

A GIORNO CON 3 VANI
OPEN WITH 3 COMPARTMENTS

A GIORNO CON 3 VANI
OPEN WITH 3 COMPARTMENTS

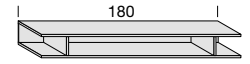
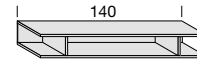
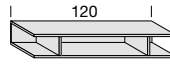
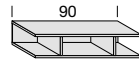

DCC2931K

DCC2941K

DCC2944K

DCC2951K

NOCE-FRASSINO / WALNUT-ASHWOOD

632

735

806

938

mc 0,08 – Kg 12

mc 0,12 – Kg 15

mc 0,14 – Kg 17

mc 0,17 – Kg 21

PENSILI H. 40 N.B.: POSIZIONAMENTO MAX PENSILE A RIBALTA H. 160

WALL UNITS H. 40
N.B.: MAX POSITION OF WALL UNIT
WITH DROP-DOWN DOOR H. 160

A GIORNO, 1 RIPIANO VETRO
OPEN, 1 GLASS SHELF

1 VASISTAS LEGNO
1 WOODEN LIFT-UP DOOR

1 VASISTAS VETRO
1 GLASS LIFT-UP DOOR

1 VASISTAS DECORATA
1 DECORATED LIFT-UP DOOR

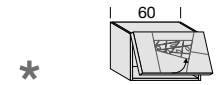
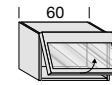
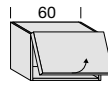
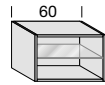

DCC2021K

DCC2102K

DCC2141K

DCC2101K

NOCE-FRASSINO / WALNUT-ASHWOOD

783

806

806

1.034

mc 0,10 – Kg 12

mc 0,10 – Kg 16

mc 0,10 – Kg 16

mc 0,10 – Kg 16

1 VASISTAS LEGNO
1 WOODEN LIFT-UP DOOR

1 VASISTAS VETRO
1 GLASS LIFT-UP DOOR

1 VASISTAS DECORATA
1 DECORATED LIFT-UP DOOR

1 RIBALTA LEGNO
1 WOODEN DROP-DOWN DOOR

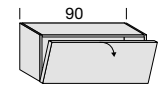
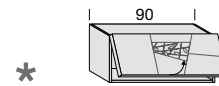
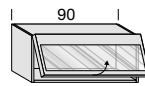
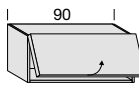

DCC2112K

DCC2151K

DCC2111K

DCC2212K

NOCE-FRASSINO / WALNUT-ASHWOOD

1.029

1.029

1.377

1.029

mc 0,17 – Kg 21

mc 0,17 – Kg 21

mc 0,17 – Kg 21

mc 0,17 – Kg 21

1 VASISTAS LEGNO
1 WOODEN LIFT-UP DOOR

1 VASISTAS VETRO
1 GLASS LIFT-UP DOOR

1 VASISTAS DECORATA
1 DECORATED LIFT-UP DOOR

1 RIBALTA LEGNO
1 WOODEN DROP-DOWN DOOR

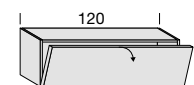
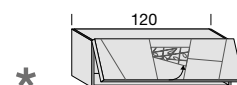
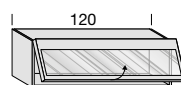
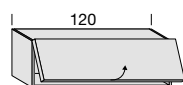

DCC2122K

DCC2161K

DCG2121K

DCC2222K

NOCE-FRASSINO / WALNUT-ASHWOOD

1.203

1.203

1.564

1.203

mc 0,20 – Kg 26

mc 0,20 – Kg 26

mc 0,20 – Kg 26

mc 0,20 – Kg 26

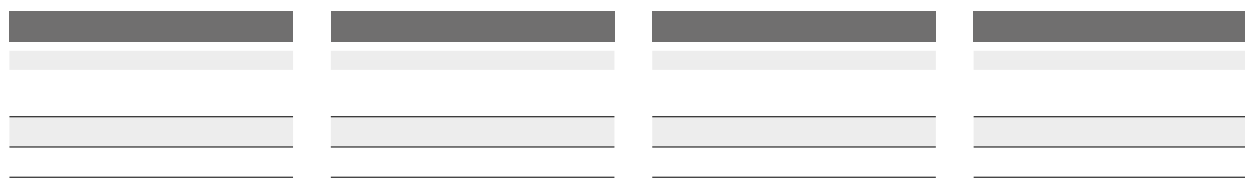

1 RIBALTA LEGNO
1 WOODEN DROP-DOWN DOOR

1 RIBALTA VETRO
1 GLASS DROP-DOWN DOOR

1 RIBALTA DECORATA
1 DECORATED DROP-DOWN DOOR

A GIORNO, 1 RIPIANO VETRO
OPEN, 1 GLASS SHELF

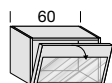
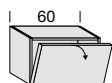

*

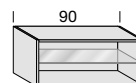
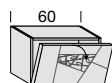

DCC2152K

DCC2241K

DCC2201K

DCC2351K

806

806

1.034

890

mc 0,10 – Kg 16

mc 0,10 – Kg 16

mc 0,10 – Kg 16

mc 0,17 – Kg 15

1 RIBALTA VETRO
1 GLASS DROP-DOWN DOOR

1 RIBALTA DECORATA
1 DECORATED DROP-DOWN DOOR

A GIORNO, 1 RIPIANO VETRO
OPEN, 1 GLASS SHELF

A GIORNO CON 3 VANI
OPEN WITH 3 COMPARTMENTS

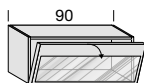

*

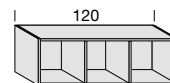
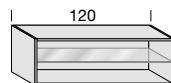
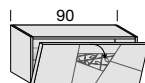

DCC2251K

DCC2211K

DCC2361K

DCC2381K

1.029

1.377

1.041

1.041

mc 0,17 – Kg 21

mc 0,17 – Kg 21

mc 0,20 – Kg 19

mc 0,20 – Kg 19

1 RIBALTA VETRO
1 GLASS DROP-DOWN DOOR

1 RIBALTA DECORATA
1 DECORATED DROP-DOWN DOOR

A GIORNO, 1 RIPIANO VETRO
OPEN, 1 GLASS SHELF

A GIORNO CON 3 VANI
OPEN WITH 3 COMPARTMENTS

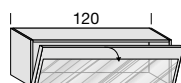

*

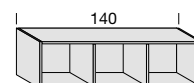
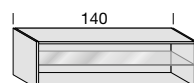
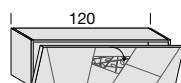

DCC2261K

DCC2221K

DCC2364K

DCC2384K

1.203

1.564

1.209

1.209

mc 0,20 – Kg 26

mc 0,20 – Kg 26

mc 0,27 – Kg 21

mc 0,27 – Kg 21

**OPTIONAL
OPTIONAL**

**BARRA LED A BASSO CONSUMO
ACCENSIONE TOUCH
IN ALLUMINIO L. 37.2**
LOW CONSUMPTION LED BAR
TOUCH SWITCH
IN ALUMINIUM W. 37.2



ZZZFE22001

163

**ALIMENTATORE
POWER SUPPLY**



ZZZFE22002

67

**COLLEGAMENTO
A CARICO DEL CLIENTE**
CONNECTIONS
TO BE MADE BY THE CUSTOMER.

**SPECIFICARE CON O SENZA
DECORO FOGLIA
(IL PREZZO È LO STESSO)**
PLEASE SPECIFY WITH OR WITHOUT
LEAF DECORATION
(THE PRICE IS THE SAME)

**POSSIBILITÀ DI FRONTALE DIVERSO
DALLA SCOCCA, SPECIFICARE LA
FINITURA SCELTA**

IN CASE OF FRONT DIFFERENT FROM
THE CARCASE CONSIDER THE
HIGHER PRICE OF THE CHOSEN
FINISH

DECOR SISTEMA COMPONIBILE - MODULAR SYSTEM

PENSILI ORIZZONTALI P. 40

HORIZONTAL WALL UNITS D. 40

PENSILI H. 40 WALL UNITS H. 40

1 VASISTAS LEGNO
1 WOODEN LIFT-UP DOOR

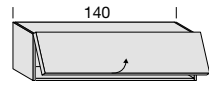

DCC2124K

NOCE-FRASSINO / WALNUT-ASHWOOD

1.395

mc 0,27 – Kg 29

1 VASISTAS VETRO
1 GLASS LIFT-UP DOOR

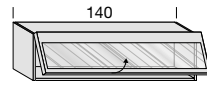

DCC2164K

1.395

mc 0,27 – Kg 29

1 VASISTAS DECORATA
1 DECORATED LIFT-UP DOOR

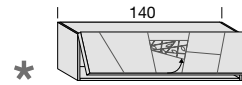

DCC2114K

1.665

mc 0,27 – Kg 29

1 RIBALTA LEGNO
1 WOODEN DROP-DOWN DOOR

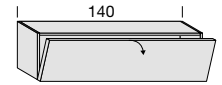

DCC2224K

1.395

mc 0,27 – Kg 29

1 VASISTAS VETRO
1 GLASS LIFT-UP DOOR

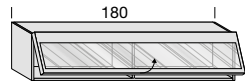

DCC2171K

NOCE-FRASSINO / WALNUT-ASHWOOD

1.521

mc 0,34 – Kg 36

1 VASISTAS DECORATA
1 DECORATED LIFT-UP DOOR

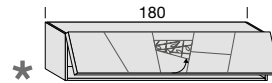

DCC2131K

1.961

mc 0,34 – Kg 36

1 RIBALTA LEGNO
1 WOODEN DROP-DOWN DOOR

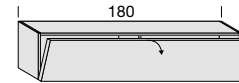

DCC2232K

1.521

mc 0,34 – Kg 36

1 RIBALTA VETRO
1 GLASS DROP-DOWN DOOR

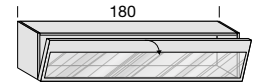

DCC2271K

1.521

mc 0,34 – Kg 36

PENSILI H. 60 WALL UNITS H. 60

A GIORNO, 1 RIPIANO VETRO
OPEN, 1 GLASS SHELF

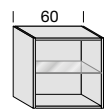

DX / RH
SX / LH

DCC2601K

NOCE-FRASSINO / WALNUT-ASHWOOD

703

mc 0,17 – Kg 14

A GIORNO CON CROCERA
OPEN WITH CROSSPIECE

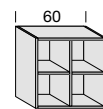

DCC2611K

818

mc 0,17 – Kg 14

1 ANTA LEGNO, 1 RIPIANO VETRO
1 WOODEN DOOR, 1 GLASS SHELF

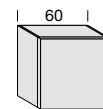

DCC2741K
DCC2742K

903

mc 0,17 – Kg 19

1 ANTA VETRO, 1 RIPIANO VETRO
1 GLASS DOOR, 1 GLASS SHELF

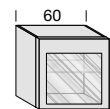

DCC2641K
DCC2642K

903

mc 0,17 – Kg 19

2 ANTE DECORATE, 2 RIPIANI VETRO
2 DECORATED DOORS, 2 GLASS SHELVES

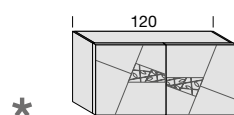

DCC2981K

NOCE-FRASSINO / WALNUT-ASHWOOD

1.803

mc 0,34 – Kg 32

1 RIBALTA VETRO
1 GLASS DROP-DOWN DOOR

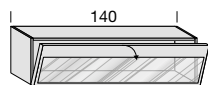

DCC2264K

1.395

mc 0,27 – Kg 29

1 RIBALTA DECORATA
1 DECORATED DROP-DOWN DOOR

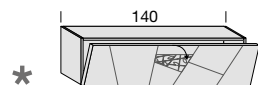

DCC2214K

1.665

mc 0,27 – Kg 29

A GIORNO, 1 RIPIANO VETRO
OPEN, 1 GLASS SHELF

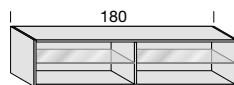

DCC2921K

1.270

mc 0,34 – Kg 25

1 VASISTAS LEGNO
1 WOODEN LIFT-UP DOOR

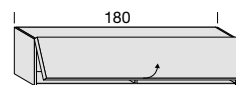

DCC2132K

1.521

mc 0,34 – Kg 36

1 RIBALTA DECORATA
1 DECORATED DROP-DOWN DOOR

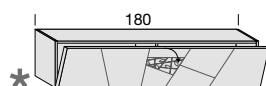

DCC2231K

1.961

mc 0,34 – Kg 36

1 ANTA DECORATA, 1 RIPIANO VETRO
1 DECORATED DOOR, 1 GLASS SHELF

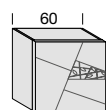

DCC2621K
DCC2622K

1.191

mc 0,17 – Kg 19

A GIORNO, 2 RIPIANI VETRO
OPEN, 2 GLASS SHELVES

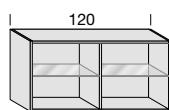

DCC2281K

1.136

mc 0,34 – Kg 21

2 ANTE LEGNO, 1 RIPIANO VETRO
2 WOODEN DOORS, 1 GLASS SHELF

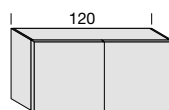

DCC2181K

1.395

mc 0,34 – Kg 32

2 ANTE VETRO, 1 RIPIANO VETRO
2 GLASS DOORS, 1 GLASS SHELF

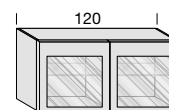

DCC2081K

1.395

mc 0,34 – Kg 32

PENSILI H. 100
WALL UNITS H. 100

A GIORNO CON CROCIERA
OPEN WITH CROSSPIECE

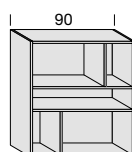

DCC2911K

1.155

mc 0,42 – Kg 38

NOCE-FRASSINO / WALNUT-ASHWOOD

OPTIONAL
OPTIONAL

BARRA LED A BASSO CONSUMO
ACCENSIONE TOUCH
IN ALLUMINIO L. 37.2
LOW CONSUMPTION LED BAR
TOUCH SWITCH
IN ALUMINIUM W. 37.2



ZZZFE22001

163

ALIMENTATORE
POWER SUPPLY



ZZZFE22002

67

COLLEGAMENTO
A CARICO DEL CLIENTE
CONNECTIONS
TO BE MADE BY THE CUSTOMER.

SPECIFICARE CON O SENZA
DECORO FOGLIA
(IL PREZZO È LO STESSO)
PLEASE SPECIFY WITH OR WITHOUT
LEAF DECORATION
(THE PRICE IS THE SAME)

POSSIBILITÀ DI FRONTALE DIVERSO
DALLA SCOCCA, SPECIFICARE LA
FINITURA SCELTA

IN CASE OF FRONT DIFFERENT FROM
THE CARCASE CONSIDER THE
HIGHER PRICE OF THE CHOSEN
FINISH

DECOR SISTEMA COMPONIBILE - MODULAR SYSTEM

PENSILI VERTICALI P. 40/41

VERTICAL WALL UNITS D. 40/41

PENSILI H. 120 WALL UNITS H. 120

A GIORNO, 2 RIPIANI VETRO
OPEN, 2 GLASS SHELVES

1 ANTA LEGNO, 2 RIPIANI VETRO
1 WOODEN DOOR, 2 GLASS SHELVES

1 ANTA VETRO, 2 RIPIANI VETRO
1 GLASS DOOR, 2 GLASS SHELVES

1 ANTA DECORATA, 2 RIPIANI VETRO
1 DECORATED DOOR, 2 GLASS SHELVES

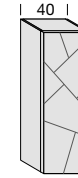
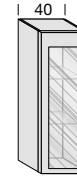
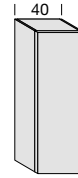
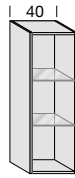

DX / RH
SX / LH

DCC2311K

**DCC2321K
DCC2322K**

**DCC2341K
DCC2342K**

**DCC2371K
DCC2372K**

NOCE-FRASSINO / WALNUT-ASHWOOD

1.041

1.155

1.155

1.473

mc 0,23 – Kg 17

mc 0,23 – Kg 24

mc 0,23 – Kg 24

mc 0,23 – Kg 24

1 ANTA VETRO, 1 ANTA LEGNO,
2 RIPIANI VETRO
1 GLASS DOOR, 1 WOODEN DOOR,
2 GLASS SHELVES

1 ANTA VETRO, 1 ANTA DECORATA,
2 RIPIANI VETRO
1 GLASS DOOR, 1 DECORATED DOOR,
2 GLASS SHELVES

4 ANTE LEGNO,
4 RIPIANI VETRO
4 WOODEN DOORS,
4 GLASS SHELVES

4 ANTE VETRO,
4 RIPIANI VETRO
4 GLASS DOORS,
4 GLASS SHELVES

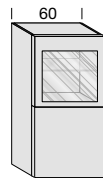

*

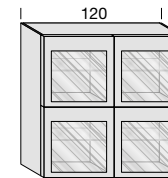
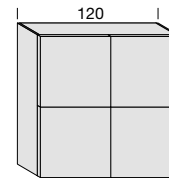

DX / RH
SX / LH

**DCC2471K
DCC2472K**

**DCC2561K
DCC2562K**

DCC2811K

DCC2821K

NOCE-FRASSINO / WALNUT-ASHWOOD

1.395

1.479

2.122

2.122

mc 0,34 – Kg 30

mc 0,34 – Kg 30

mc 0,68 – Kg 50

mc 0,68 – Kg 50

PENSILI H. 124.4 CON CORNICE PERIMETRALE WALL UNITS H. 124.4 WITH PERIMETRIC FRAME

A GIORNO, 2 RIPIANI VETRO
OPEN, 2 GLASS SHELVES

2 ANTE LEGNO,
2 RIPIANI VETRO
2 WOODEN DOORS,
2 GLASS SHELVES

2 ANTE VETRO,
2 RIPIANI VETRO
2 GLASS DOORS,
2 GLASS SHELVES

2 ANTE DECORATE,
2 RIPIANI VETRO
2 DECORATED DOORS,
2 GLASS SHELVES

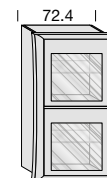
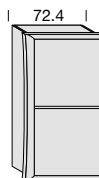
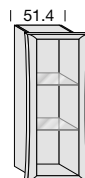

*

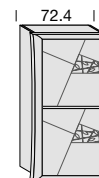

DX / RH
SX / LH

DCC2481K

**DCC2501K
DCC2502K**

**DCC2521K
DCC2522K**

**DCC2591K
DCC2592K**

NOCE-FRASSINO / WALNUT-ASHWOOD

1.089

1.486

1.486

1.665

mc 0,32 – Kg 20

mc 0,44 – Kg 36

mc 0,44 – Kg 36

mc 0,44 – Kg 36

4 ANTE DECORATE,
4 RIPIANI VETRO
4 DECORATED DOORS,
4 GLASS SHELVES

2 ANTE DECORATE, 2 ANTE LEGNO,
4 RIPIANI VETRO
2 DECORATED DOORS, 2 WOODEN DOORS,
4 GLASS SHELVES

2 ANTE VETRO, 2 ANTE LEGNO,
4 RIPIANI VETRO
2 GLASS DOORS, 2 WOODEN DOORS,
4 GLASS SHELVES

2 ANTE VETRO, 2 ANTE DECORATE,
4 RIPIANI VETRO
2 GLASS DOORS, 2 DECORATED DOORS,
4 GLASS SHELVES

*

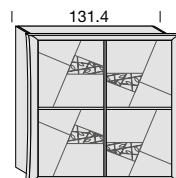

*

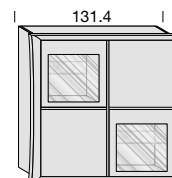
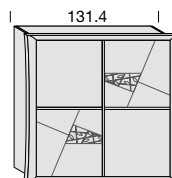

*

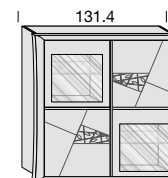

DCC2791K

DCC2711K

DCC2871K

DCC2891K

NOCE-FRASSINO / WALNUT-ASHWOOD

2.664

2.514

2.279

2.514

mc 0,80 – Kg 58

mc 0,80 – Kg 58

mc 0,80 – Kg 58

mc 0,80 – Kg 58

A GIORNO, 2 RIPIANI VETRO,
1 RIPIANO LEGNO
OPEN, 2 GLASS SHELVES,
1 WOODEN SHELF



DCC2401K

1.130

mc 0,34 – Kg 19

2 ANTE LEGNO,
2 RIPIANI VETRO
2 WOODEN DOORS,
2 GLASS SHELVES

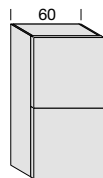

**DCC2411K
DCC2412K**

1.395

mc 0,34 – Kg 30

2 ANTE VETRO,
2 RIPIANI VETRO
2 GLASS DOORS,
2 GLASS SHELVES

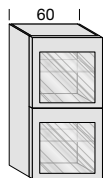

**DCC2431K
DCC2432K**

1.395

mc 0,34 – Kg 30

2 ANTE DECORATE,
2 RIPIANI VETRO
2 DECORATED DOORS,
2 GLASS SHELVES



*

**DCC2581K
DCC2582K**

1.545

mc 0,34 – Kg 30

4 ANTE DECORATE,
4 RIPIANI VETRO
4 DECORATED DOORS,
4 GLASS SHELVES

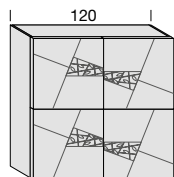

*

DCC2781K

2.525

mc 0,68 – Kg 50

2 ANTE DECORATE, 2 ANTE LEGNO,
4 RIPIANI VETRO
2 DECORATED DOORS, 2 WOODEN DOORS,
4 GLASS SHELVES

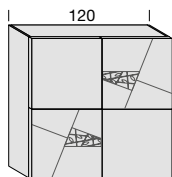

*

DCC2751K

2.393

mc 0,68 – Kg 50

2 ANTE VETRO, 2 ANTE LEGNO,
4 RIPIANI VETRO
2 GLASS DOORS, 2 WOODEN DOORS,
4 GLASS SHELVES

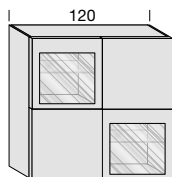

DCC2861K

2.122

mc 0,68 – Kg 50

2 ANTE VETRO, 2 ANTE DECORATE,
4 RIPIANI VETRO
2 GLASS DOORS, 2 DECORATED DOORS,
4 GLASS SHELVES

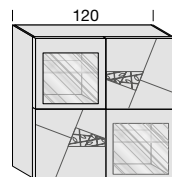

*

DCC2881K

2.393

mc 0,68 – Kg 50

1 ANTA VETRO, 1 ANTA LEGNO,
2 RIPIANI VETRO
1 GLASS DOOR, 1 WOODEN DOOR,
2 GLASS SHELVES

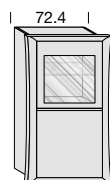

**DCC2541K
DCC2542K**

1.486

mc 0,44 – Kg 36

1 ANTA VETRO, 1 ANTA DECORATA,
2 RIPIANI VETRO
1 GLASS DOOR, 1 DECORATED DOOR,
2 GLASS SHELVES

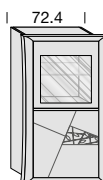

*

**DCC2571K
DCC2572K**

1.587

mc 0,44 – Kg 36

4 ANTE LEGNO,
4 RIPIANI VETRO
4 WOODEN DOORS,
4 GLASS SHELVES

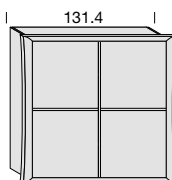

DCC2841K

2.279

mc 0,80 – Kg 58

4 ANTE VETRO,
4 RIPIANI VETRO
4 GLASS DOORS,
4 GLASS SHELVES

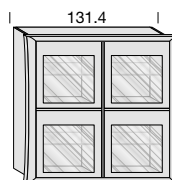

DCC2851K

2.279

mc 0,80 – Kg 58

OPTIONAL OPTIONAL

BARRA LED A BASSO CONSUMO
ACCENSIONE TOUCH
IN ALLUMINIO L. 37.2
LOW CONSUMPTION LED BAR
TOUCH SWITCH
IN ALUMINIUM W. 37.2



ZZZFE22001

163

ALIMENTATORE
POWER SUPPLY



ZZZFE22002

67

COLLEGAMENTO
A CARICO DEL CLIENTE
CONNECTIONS
TO BE MADE BY THE CUSTOMER.

*
SPECIFICARE CON O SENZA
DECORO FOGLIA
(IL PREZZO È LO STESSO)
PLEASE SPECIFY WITH OR WITHOUT
LEAF DECORATION
(THE PRICE IS THE SAME)

POSSIBILITÀ DI FRONTALE DIVERSO
DALLA SCOCCA, SPECIFICARE LA
FINITURA SCELTA

IN CASE OF FRONT DIFFERENT FROM
THE CARCASE CONSIDER THE
HIGHER PRICE OF THE CHOSEN
FINISH

DECOR SISTEMA COMPONIBILE - MODULAR SYSTEM

MADIE E VETRINE P. 40/50

CUPBOARDS AND DISPLAY UNITS D. 40/50

MADIA H. 63 P. 40
CUPBOARD H. 63 D. 40

2 ANTE LEGNO, 3 CASSETTI, 2 RIPIANI VETRO
2 WOODEN DOORS, 3 DRAWERS, 2 GLASS SHELVES

2 ANTE DECORATE, 3 CASSETTI, 2 RIPIANI VETRO
2 DECORATED DOORS, 3 DRAWERS, 2 GLASS SHELVES

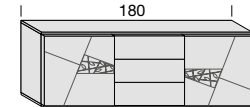
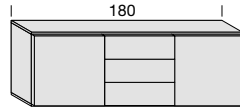

*

DCC6101K

DCC6201K

NOCE-FRASSINO / WALNUT-ASHWOOD

2.410

2.778

mc 0,54 – Kg 80

mc 0,54 – Kg 80

MADIA H. 63 P. 50
CUPBOARD H. 63 D. 50

2 ANTE LEGNO, 3 CASSETTI, 2 RIPIANI VETRO
2 WOODEN DOORS, 3 DRAWERS, 2 GLASS SHELVES

2 ANTE DECORATE, 3 CASSETTI, 2 RIPIANI VETRO
2 DECORATED DOORS, 3 DRAWERS, 2 GLASS SHELVES

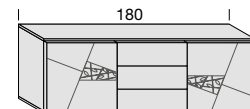
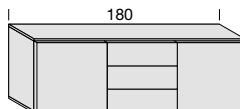

*

DCC6105K

DCC6205K

NOCE-FRASSINO / WALNUT-ASHWOOD

2.627

2.988

mc 0,67 – Kg 100

mc 0,67 – Kg 100

MADIA H. 123 P. 40
CUPBOARD H. 123 D. 40

4 ANTE LEGNO,
4 RIPIANI VETRO
4 WOODEN DOORS,
4 GLASS SHELVES

4 ANTE VETRO,
4 RIPIANI VETRO
4 GLASS DOORS,
4 GLASS SHELVES

2 ANTE VETRO, 2 ANTE LEGNO,
4 RIPIANI VETRO
2 GLASS DOORS, 2 WOODEN DOORS,
4 GLASS SHELVES

4 ANTE DECORATE,
4 RIPIANI VETRO
4 DECORATED DOORS,
4 GLASS SHELVES

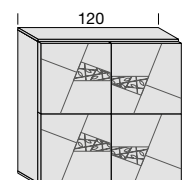
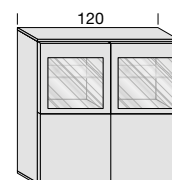
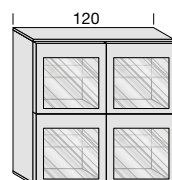
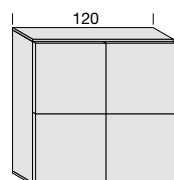

*

DCC6121K

DCC6131K

DCC6141K

DCC6221K

NOCE-FRASSINO / WALNUT-ASHWOOD

2.279

2.279

2.279

2.946

mc 0,70 – Kg 52

mc 0,70 – Kg 52

mc 0,70 – Kg 52

mc 0,70 – Kg 52

4 ANTE LEGNO, 2 RIPIANI VETRO
4 WOODEN DOORS, 2 GLASS SHELVES

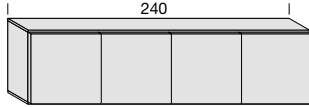

4 ANTE DECORATE, 2 RIPIANI VETRO
4 DECORATED DOORS, 2 GLASS SHELVES

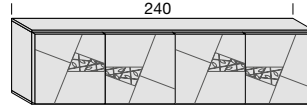

*

DCC6111K

2.669

mc 0,72 – Kg 112

DCC6311K

3.463

mc 0,72 – Kg 112

4 ANTE LEGNO, 2 RIPIANI VETRO
4 WOODEN DOORS, 2 GLASS SHELVES

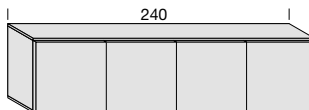

4 ANTE DECORATE, 2 RIPIANI VETRO
4 DECORATED DOORS, 2 GLASS SHELVES



*

DCC6115K

2.946

mc 0,90 – Kg 140

DCC6315K

3.745

mc 0,90 – Kg 140

2 ANTE VETRO, 2 ANTE DECORATE,
4 RIPIANI VETRO
2 GLASS DOORS, 2 DECORATED DOORS,
4 GLASS SHELVES

VETRINA H. 208 P. 40
DISPLAY UNIT H. 208 D. 40
2 ANTE VETRO
2 GLASS DOORS

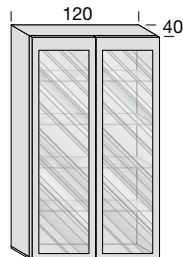

4 RIPIANI VETRO
4 GLASS SHELVES

DCC6241K

2.610

mc 0,70 – Kg 52

DCC6011K

2.892

mc 1,18 – Kg 96

CAPPOTTIERA H. 208 P. 50
COAT WARDROBE H. 208 D. 50
2 ANTE LEGNO
2 WOODEN DOORS

NEW

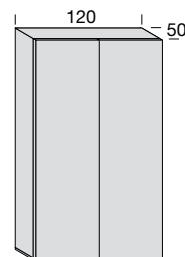

1 RIPIANO LEGNO, 1 TUBO APPENDIABITI
1 WOODEN SHELF, 1 CLOTHES HANGER TUBE

DCC6001K

2.892

mc 1,18 – Kg 96

OPTIONAL
OPTIONAL

BARRA LED A BASSO CONSUMO
ACCENSIONE TOUCH
IN ALLUMINIO L. 37.2
LOW CONSUMPTION LED BAR
TOUCH SWITCH
IN ALUMINIUM W. 37.2



ZZZFE22001

163

ALIMENTATORE
POWER SUPPLY



ZZZFE22002

67

COLLEGAMENTO
A CARICO DEL CLIENTE
CONNECTIONS
TO BE MADE BY THE CUSTOMER.

*
SPECIFICARE CON O SENZA
DECORO FOGLIA
(IL PREZZO È LO STESSO)
PLEASE SPECIFY WITH OR WITHOUT
LEAF DECORATION
(THE PRICE IS THE SAME)

POSSIBILITÀ DI FRONTALE DIVERSO
DALLA SCOCCA, SPECIFICARE LA
FINITURA SCELTA

IN CASE OF FRONT DIFFERENT FROM
THE CARCASE CONSIDER THE
HIGHER PRICE OF THE CHOSEN
FINISH

DECOR SISTEMA COMPONIBILE - MODULAR SYSTEM

COMPOSIZIONI A CATALOGO CATALOGUE COMPOSITIONS

POSSIBILITÀ DI FRONTALE DIVERSO DALLA SCOCCA, SPECIFICARE LA FINITURA SCELTA
IN CASE OF FRONT DIFFERENT FROM THE CARCASE CONSIDER THE HIGHER PRICE OF THE CHOSEN FINISH

COMPOSIZIONE 122 COMPOSITION 122

PAG. 38 CATALOGO "PROPOSTE ARREDATIVE"
PAGE 38 "FURNISHING SOLUTIONS" CATALOGUE

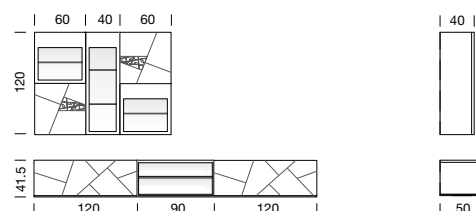
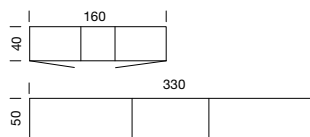

			NOCE FRASSINO
2	DCC1181K	BASE A TERRA CON CESTONE DECORATO L 120 P 50 FLOOR-STANDING BASE UNIT WITH DECORATED BASKET W 120 D 50	3.138
1	DCC1101K	BASE A TERRA A GIORNO CON RIPIANO LEGNO L 90 P 50 OPEN FLOOR-STANDING BASE UNIT WITH WOODEN SHELF W 90 D 50	848
1	DCC2562K	PENSILE ANTA VETRO E ANTA DECORATA CON DECORO FOGLIA L 60 H 120 WALL UNIT WITH GLASS DOOR AND DECORATED DOOR WITH LEAF DECORATION W 60 H 120	1.479
1	DCC2561K	PENSILE ANTA VETRO E ANTA DECORATA CON DECORO FOGLIA L 60 H 120 WALL UNIT WITH GLASS DOOR AND DECORATED DOOR WITH LEAF DECORATION W 60 H 120	1.479
1	DCC2342K	PENSILE VERTICALE ANTA VETRO L 40 H 120 VERTICAL WALL UNIT WITH GLASS DOOR W 40 H 120	1.155
DCC0122K PREZZO TOTALE COMPOSIZIONE TOTAL PRICE FOR COMPOSITION			8.099



L. W. 330
P. D. 40/50

COMPOSIZIONE 176 COMPOSITION 176

PAG. 39 CATALOGO "PROPOSTE ARREDATIVE"
PAGE 39 "FURNISHING SOLUTIONS" CATALOGUE

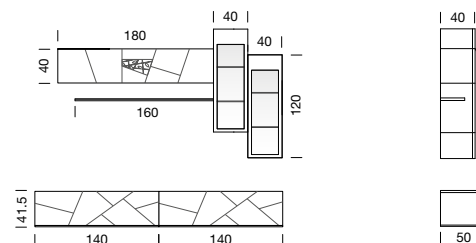
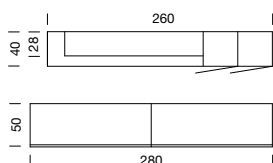

			NOCE FRASSINO
2	DCC1484K	BASE A TERRA CON CESTONE DECORATO L 140 P 50 FLOOR-STANDING BASE UNIT WITH DECORATED BASKET W 140 D 50	3.704
1	DCC2131K	PENSILE VASISTAS ANTA DECORATA CON DECORO FOGLIA L 180 WALL UNIT WITH LIFT-UP DOOR WITH LEAF DECORATION W 180	1.961
1	PFC3551K	MENSOLA L 160 SHELF W 160	362
2	DCC2341K	PENSILE ANTA VETRO L 40 H 120 WALL UNIT WITH GLASS DOOR W 40 H 120	2.310
DCC0176K PREZZO TOTALE COMPOSIZIONE TOTAL PRICE FOR COMPOSITION			8.337

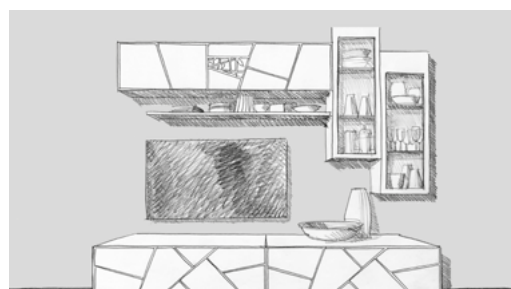

L. W. 280
P. D. 40/50

COMPOSIZIONE 126 COMPOSITION 126

PAG. 40 CATALOGO "PROPOSTE ARREDATIVE"
PAGE 40 "FURNISHING SOLUTIONS" CATALOGUE

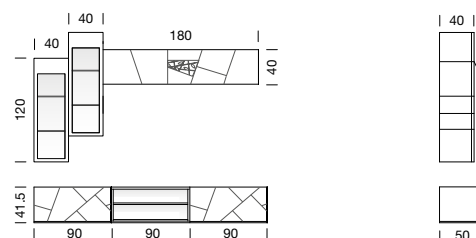
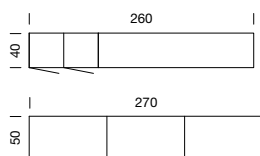

			NOCE FRASSINO
2	DCC1161K	BASE A TERRA CON CESTONE DECORATO L 90 P 50 FLOOR-STANDING BASE UNIT WITH DECORATED BASKET W 90 D 50	2.576
1	DCC1101K	BASE A TERRA A GIORNO CON RIPIANO LEGNO L 90 P 50 OPEN FLOOR-STANDING BASE UNIT WITH WOODEN SHELF W 90 D 50	848
2	DCC2342K	PENSILE ANTA VETRO L 40 H 120 WALL UNIT WITH GLASS DOOR W 40 H 120	2.310
1	DCC2131K	PENSILE VASISTAS ANTA DECORATA CON DECORO FOGLIA L 180 WALL UNIT WITH LIFT-UP DOOR WITH LEAF DECORATION W 180	1.961
DCC0126K PREZZO TOTALE COMPOSIZIONE TOTAL PRICE FOR COMPOSITION			7.695

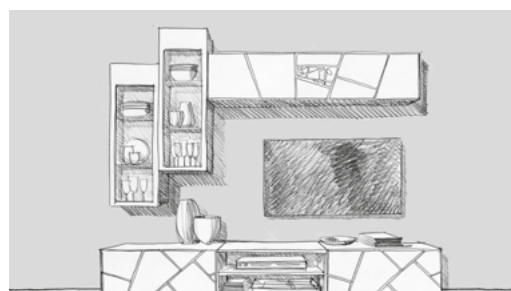

L. W. 270
P. D. 40/50

COMPOSIZIONI A CATALOGO CATALOGUE COMPOSITIONS

POSSIBILITÀ DI FRONTALE DIVERSO DALLA SCOCCA, SPECIFICARE LA FINITURA SCELTA
IN CASE OF FRONT DIFFERENT FROM THE CARCASE, CONSIDER THE HIGHER PRICE OF THE CHOOSEN FINISH

COMPOSIZIONE 128

COMPOSITION 128

PAG. 41 CATALOGO "PROPOSTE ARREDATIVE"
PAGE 41 "FURNISHING SOLUTIONS" CATALOGUE

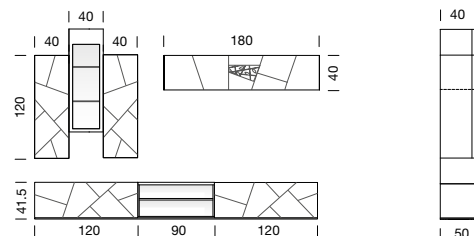
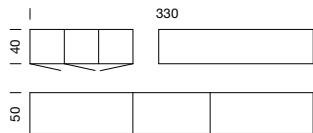

			NOCE FRASSINO
2	DCC1181K	BASE A TERRA CON CESTONE DECORATO L 120 P 50 FLOOR-STANDING BASE UNIT WITH DECORATED BASKET W 120 D 50	3.138
1	DCC1101K	BASE A TERRA A GIORNO CON RIPIANO LEGNO L 90 P 50 OPEN FLOOR-STANDING BASE UNIT WITH WOODEN SHELF W 90 D 50	848
1	DCC2372K	PENSILE ANTA DECORATA L 40 H 120 WALL UNIT WITH DECORATED DOOR W 40 H 120	1.473
1	DCC2371K	PENSILE ANTA DECORATA L 40 H 120 WALL UNIT WITH DECORATED DOOR W 40 H 120	1.473
1	DCC2342K	PENSILE ANTA VETRO L 40 H 120 WALL UNIT WITH GLASS DOOR W 40 H 120	1.155
1	DCC2131K	PENSILE VASISTAS ANTA DECORATA CON DECORO FOGLIA L 180 WALL UNIT WITH LIFT-UP DOOR WITH LEAF DECORATION W 180	1.961
DCC0128K PREZZO TOTALE COMPOSIZIONE TOTAL PRICE FOR COMPOSITION			10.048

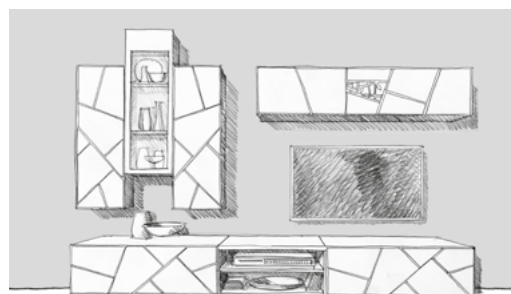

L. W. 330
P. D. 40/50

COMPOSIZIONE 132

COMPOSITION 132

PAG. 42 CATALOGO "PROPOSTE ARREDATIVE"
PAGE 42 "FURNISHING SOLUTIONS" CATALOGUE

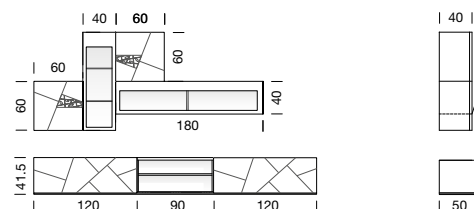
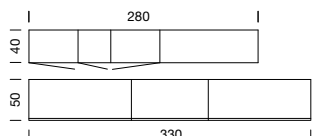

			NOCE FRASSINO
2	DCC1181K	BASE A TERRA CON CESTONE DECORATO L 120 P 50 FLOOR-STANDING BASE UNIT WITH DECORATED BASKET W 120 D 50	3.138
1	DCC1101K	BASE A TERRA A GIORNO CON RIPIANO LEGNO L 90 P 50 OPEN FLOOR-STANDING BASE UNIT WITH WOODEN SHELF W 90 D 50	848
1	DCC2622K	PENSILE ANTA DECORATA CON DECORO FOGLIA L 60 H 60 WALL UNIT WITH DOOR WITH LEAF DECORATION W 60 H 60	1.191
1	DCC2621K	PENSILE ANTA DECORATA CON DECORO FOGLIA L 60 H 60 WALL UNIT WITH DOOR WITH LEAF DECORATION W 60 H 60	1.191
1	DCC2342K	PENSILE ANTA VETRO L 40 H 120 WALL UNIT WITH GLASS DOOR W 40 H 120	1.155
1	DCC2271K	PENSILE RIBALTA ANTA VETRO L 180 WALL UNIT WITH GLASS DROP-DOWN DOOR W 180	1.521
DCC0132K PREZZO TOTALE COMPOSIZIONE TOTAL PRICE FOR COMPOSITION			9.044



L. W. 330
P. D. 40/50

COMPOSIZIONE 134

COMPOSITION 134

PAG. 43 CATALOGO "PROPOSTE ARREDATIVE"
PAGE 43 "FURNISHING SOLUTIONS" CATALOGUE

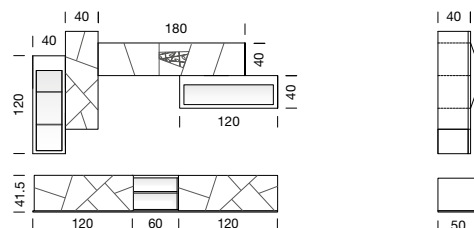
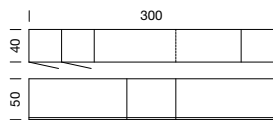

			NOCE FRASSINO
2	DCC1181K	BASE A TERRA CON CESTONE DECORATO L 120 P 50 FLOOR-STANDING BASE UNIT WITH DECORATED BASKET W 120 D 50	3.138
1	DCC1081K	BASE A TERRA A GIORNO CON RIPIANO LEGNO L 60 P 50 OPEN FLOOR-STANDING BASE UNIT WITH WOODEN SHELF W 60 D 50	735
1	DCC2342K	PENSILE ANTA VETRO L 40 H 120 WALL UNIT WITH GLASS DOOR W 40 H 120	1.155
1	DCC2372K	PENSILE ANTA DECORATA L 40 H 120 WALL UNIT WITH DECORATED DOOR W 40 H 120	1.473
1	DCC2131K	PENSILE VASISTAS ANTA DECORATA CON DECORO FOGLIA L 180 WALL UNIT WITH LIFT-UP DOOR WITH LEAF DECORATION W 180	1.961
1	DCC2261K	PENSILE RIBALTA ANTA VETRO L 120 WALL UNIT WITH GLASS DROP-DOWN DOOR W 120	1.203
DCC0134K PREZZO TOTALE COMPOSIZIONE TOTAL PRICE FOR COMPOSITION			9.665

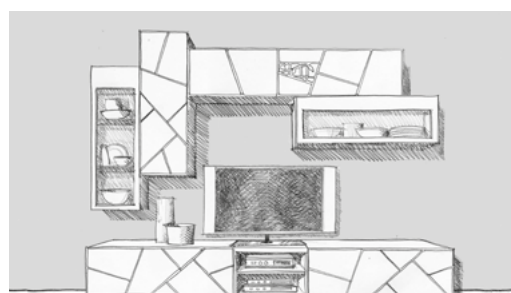

L. W. 300
P. D. 40/50

DECOR SISTEMA COMPONIBILE - MODULAR SYSTEM

COMPOSIZIONI A CATALOGO CATALOGUE COMPOSITIONS

POSSIBILITÀ DI FRONTALE DIVERSO DALLA SCOCCA, SPECIFICARE LA FINITURA SCELTA
IN CASE OF FRONT DIFFERENT FROM THE CARCASE CONSIDER THE HIGHER PRICE OF THE CHOSEN FINISH

COMPOSIZIONE 136

COMPOSITION 136

PAG. 44 CATALOGO "PROPOSTE ARREDATIVE"
PAGE 44 "FURNISHING SOLUTIONS" CATALOGUE

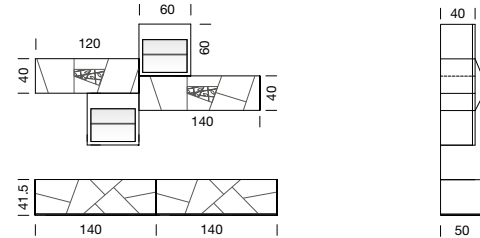
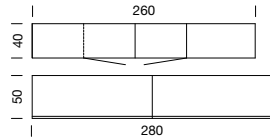

		NOCE FRASSINO
2	DCC1484K BASE A TERRA CON CESTONE DECORATO L 140 P 50 FLOOR-STANDING BASE UNIT WITH DECORATED BASKET W 140 D 50	3.704
1	DCC2642K PENSILE ANTA VETRO L 60 H 60 (SX) WALL UNIT WITH GLASS DOOR LH W 60 H 60 (LH)	903
1	DCC2641K PENSILE ANTA VETRO L 60 H 60 (DX) WALL UNIT WITH GLASS DOOR RH W 60 H 60 (RH)	903
1	DCC2121K PENSILE VASISTAS ANTA DECORATA CON DECORO FOGLIA L 120 WALL UNIT WITH LIFT-UP DOOR WITH LEAF DECORATION W 120	1.564
1	DCC2214K PENSILE RIBALTA ANTA DECORATA CON DECORO FOGLIA L 140 WALL UNIT WITH DROP-DOWN DOOR WITH LEAF DECORATION W 140	1.665
DCC0136K PREZZO TOTALE COMPOSIZIONE TOTAL PRICE FOR COMPOSITION		8.739

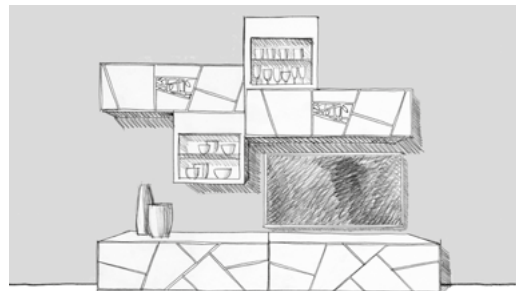

L. W. 280
P. D. 40/50

COMPOSIZIONE 138

COMPOSITION 138

PAG. 45 CATALOGO "PROPOSTE ARREDATIVE"
PAGE 45 "FURNISHING SOLUTIONS" CATALOGUE

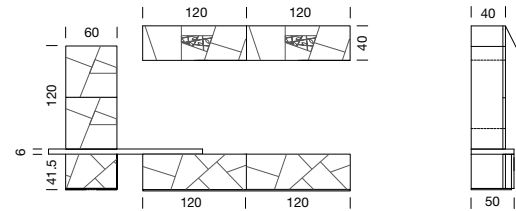
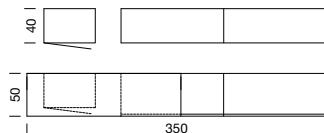

		NOCE FRASSINO
2	DCC1181K BASE A TERRA CON CESTONE DECORATO L 120 P 50 FLOOR-STANDING BASE UNIT WITH DECORATED BASKET W 120 D 50	3.138
1	DCC1932K BASE A TERRA ANTA DECORATA L 60 H 41,5 P 40 FLOOR-STANDING BASE UNIT WITH DECORATED DOOR W 60 H 41.5 D 40	920
1	DCC3031K MENSOLONE L 180 P 50 LARGE SHELF W 180 D 50	553
1	DCC2582K PENSILE 2 ANTE DECORATE L 60 H 120 VERTICAL WALL UNIT WITH 2 DECORATED DOORS W 60 H 120	1.545
2	DCC2121K PENSILE VASISTAS ANTA DECORATA CON DECORO FOGLIA L 120 WALL UNIT WITH LIFT-UP DOOR WITH LEAF DECORATION W 120	3.128
DCC0138K PREZZO TOTALE COMPOSIZIONE TOTAL PRICE FOR COMPOSITION		9.284

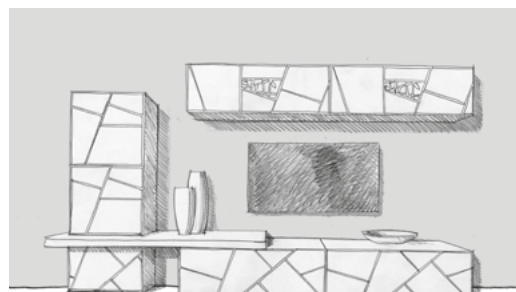

L. W. 350
P. D. 40/50

COMPOSIZIONE 140

COMPOSITION 140

PAG. 47 CATALOGO "PROPOSTE ARREDATIVE"
PAGE 47 "FURNISHING SOLUTIONS" CATALOGUE

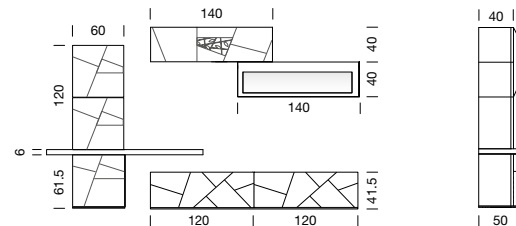
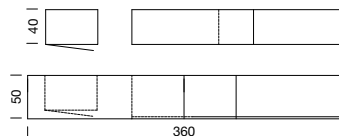

		NOCE FRASSINO
2	DCC1181K BASE A TERRA CON CESTONE DECORATO L 120 P 50 FLOOR-STANDING BASE UNIT WITH DECORATED BASKET W 120 D 50	3.138
1	DCC3131K BASE A TERRA ANTA DECORATA L 60 H 61,5 P 40 FLOOR-STANDING BASE UNIT WITH DECORATED DOOR LH W 60 H 61.5 D 40	1.136
1	DCC3031K MENSOLONE L 180 P 50 LARGE SHELF W 180 D 50	553
1	DCC2582K PENSILE 2 ANTE DECORATE L 60 H 120 WALL UNIT WITH 2 DECORATED DOORS W 60 H 120	1.545
1	DCC2114K PENSILE VASISTAS ANTA DECORATA CON DECORO FOGLIA L 140 WALL UNIT WITH LIFT-UP DOOR WITH LEAF DECORATION W 140	1.665
1	DCC2264K PENSILE RIBALTA ANTA VETRO L 140 WALL UNIT WITH GLASS DROP-DOWN DOOR W 140	1.395
DCC0140K PREZZO TOTALE COMPOSIZIONE TOTAL PRICE FOR COMPOSITION		9.432



L. W. 360
P. D. 40/50

COMPOSIZIONI A CATALOGO CATALOGUE COMPOSITIONS

POSSIBILITÀ DI FRONTALE DIVERSO DALLA SCOCCA, SPECIFICARE LA FINITURA SCELTA
IN CASE OF FRONT DIFFERENT FROM THE CARCASE CONSIDER THE HIGHER PRICE OF THE CHOOSEN FINISH

COMPOSIZIONE 146

COMPOSITION 146

PAG. 50 CATALOGO "PROPOSTE ARREDATIVE"
PAGE 50 "FURNISHING SOLUTIONS" CATALOGUE

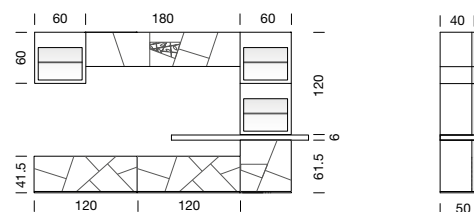
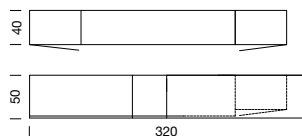

			NOCE FRASSINO
2	DCC1181K	BASE A TERRA CON CESTONE DECORATO L 120 P 50 FLOOR-STANDING BASE UNIT WITH DECORATED BASKET W 120 D 50	3.138
1	DCC3531K	BASE A TERRA ANTA DECORATA L 60 H 61,5 P 40 FLOOR-STANDING BASE UNIT WITH DECORATED DOOR W 60 H 61,5 D 40	1.136
1	DCC3061K	MENSOLONE L 160 P 50 LARGE SHELF W 160 D 50	511
1	DCC2431K	PENSILE 2 ANTE VETRO L 60 H 120 WALL UNIT WITH 2 GLASS DOORS W 60 H 120	1.395
1	DCC2131K	PENSILE VASISTAS ANTA DECORATA CON DECORO FOGLIA L 180 WALL UNIT WITH LIFT-UP DOOR WITH LEAF DECORATION W 180	1.961
1	DCC2642K	PENSILE ANTA VETRO L 60 H 60 WALL UNIT WITH GLASS DOOR W 60 H 60	903
DCC0146K PREZZO TOTALE COMPOSIZIONE TOTAL PRICE FOR COMPOSITION			9.044

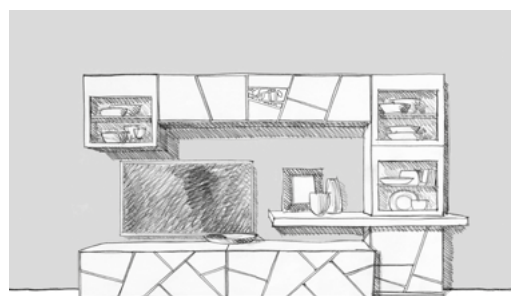

L. W. 320
P. D. 40/50

COMPOSIZIONE 148

COMPOSITION 148

PAG. 51 CATALOGO "PROPOSTE ARREDATIVE"
PAGE 51 "FURNISHING SOLUTIONS" CATALOGUE

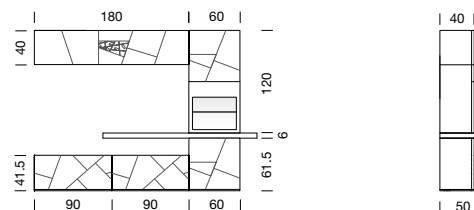
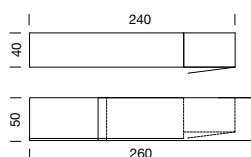

			NOCE FRASSINO
2	DCC1161K	BASE A TERRA CON CESTONE DECORATO L 90 P 50 FLOOR-STANDING BASE UNIT WITH DECORATED DOOR W 90 D 50	2.576
1	DCC3531K	BASE A TERRA ANTA DECORATA L 60 H 61,5 P 40 FLOOR-STANDING BASE UNIT WITH DECORATED DOOR RH W 60 H 61,5 D 40	1.136
1	DCC3031K	MENSOLONE L 180 P 50 LARGE SHELF W 180 D 50	553
1	DCC2561K	PENSILE ANTA DECORATA E ANTA VETRO L 60 H 120 WALL UNIT WITH DECORATED DOOR AND GLASS DOOR W 60 H 120	1.479
1	DCC2131K	PENSILE VASISTAS ANTA DECORATA CON DECORO FOGLIA L 180 WALL UNIT WITH LIFT-UP DOOR WITH LEAF DECORATION W 180	1.961
DCC0148K PREZZO TOTALE COMPOSIZIONE TOTAL PRICE FOR COMPOSITION			7.705

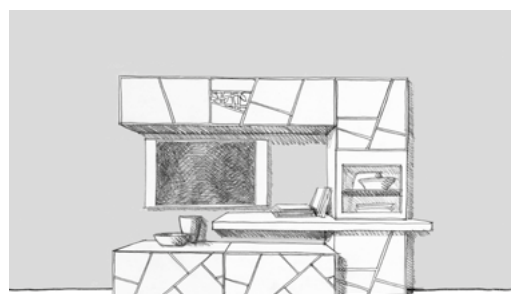

L. W. 260
P. D. 40/50

COMPOSIZIONE 150

COMPOSITION 150

PAG. 52 CATALOGO "PROPOSTE ARREDATIVE"
PAGE 52 "FURNISHING SOLUTIONS" CATALOGUE

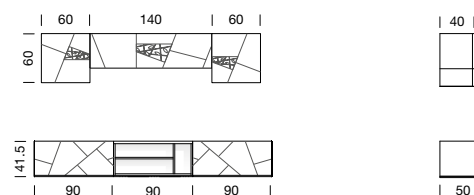
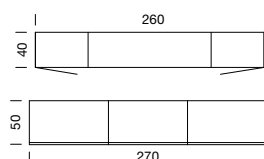

			NOCE FRASSINO
2	DCC1161K	BASE A TERRA CON CESTONE DECORATO L 90 P 50 FLOOR-STANDING BASE UNIT WITH DECORATED BASKET W 90 D 50	2.576
1	DCC1231K	BASE A TERRA A GIORNO CON RIPIANO LEGNO E DIVISORIO L 90 P 50 OPEN FLOOR-STANDING BASE UNIT WITH WOODEN SHELF AND PARTITION W 90 D 50	903
1	DCC2622K	PENSILE ANTA DECORATA CON DECORO FOGLIA L 60 H 60 (SX) WALL UNIT WITH DOOR LH WITH LEAF DECORATION W 60 H 60 (LH)	1.191
1	DCC2621K	PENSILE ANTA DECORATA CON DECORO FOGLIA L 60 H 60 (DX) WALL UNIT WITH DOOR LH WITH LEAF DECORATION W 60 H 60 (RH)	1.191
1	DCC2114K	PENSILE VASISTAS ANTA DECORATA CON DECORO FOGLIA L 140 WALL UNIT WITH LIFT-UP DOOR WITH LEAF DECORATION W 140	1.665
DCC0150K PREZZO TOTALE COMPOSIZIONE TOTAL PRICE FOR COMPOSITION			7.526

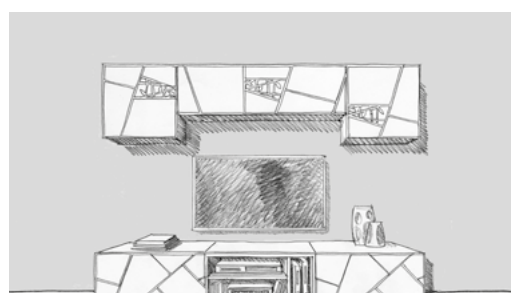

L. W. 270
P. D. 40/50

DECOR SISTEMA COMPONIBILE - MODULAR SYSTEM

COMPOSIZIONI A CATALOGO CATALOGUE COMPOSITIONS

POSSIBILITÀ DI FRONTALE DIVERSO DALLA SCOCCA, SPECIFICARE LA FINITURA SCELTA
IN CASE OF FRONT DIFFERENT FROM THE CARCASE CONSIDER THE HIGHER PRICE OF THE CHOSEN FINISH

COMPOSIZIONE 152

COMPOSITION 152

PAG. 53 CATALOGO "PROPOSTE ARREDATIVE"
PAGE 53 "FURNISHING SOLUTIONS" CATALOGUE

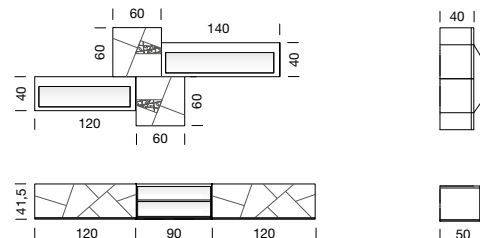
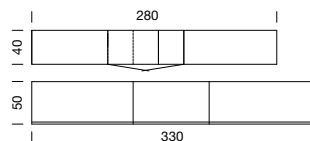

			NOCE FRASSINO
2	DCC1181K	BASE A TERRA CON CESTONE DECORATO L 120 P 50 FLOOR-STANDING BASE UNIT WITH DECORATED BASKET W 120 D 50	3.138
1	DCC1101K	BASE A TERRA A GIORNO CON RIPIANO LEGNO L 90 P 50 OPEN FLOOR-STANDING OPEN BASE UNIT WITH WOODEN SHELF W 90 D 50	848
1	DCC2261K	PENSILE RIBALTA ANTA VETRO L 120 WALL UNIT WITH GLASS DROP-DOWN DOOR W 120	1.203
1	DCC2622K	PENSILE ANTA DECORATA CON DECORO FOGLIA L 60 H 60 (SX) WALL UNIT WITH DOOR WITH LEAF DECORATION W 60 H 60 (LH)	1.191
1	DCC2621K	PENSILE ANTA DECORATA CON DECORO FOGLIA L 60 H 60 (DX) WALL UNIT WITH DOOR WITH LEAF DECORATION W 60 H 60 (RH)	1.191
1	DCC2164K	PENSILE VASISTAS ANTA VETRO L 140 WALL UNIT WITH GLASS LIFT-UP DOOR W 140	1.395
DCC0152K PREZZO TOTALE COMPOSIZIONE TOTAL PRICE FOR COMPOSITION			8.966



L. W. 330
P. D. 40/50

COMPOSIZIONE 156

COMPOSITION 156

PAG. 55 CATALOGO "PROPOSTE ARREDATIVE"
PAGE 55 "FURNISHING SOLUTIONS" CATALOGUE

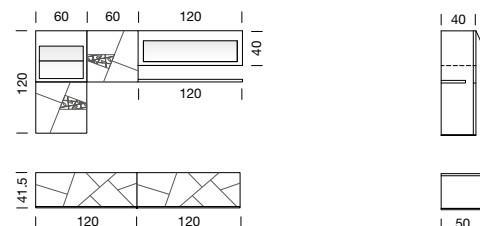
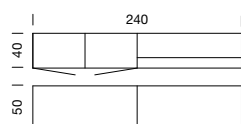

			NOCE FRASSINO
2	DCC1181K	BASE A TERRA CON CESTONE DECORATO L 120 P 50 FLOOR-STANDING BASE UNIT WITH DECORATED BASKET W 120 D 50	3.138
1	DCC2562K	PENSILE ANTA VETRO E ANTA DECORATA CON DECORO FOGLIA L 60 H 120 WALL UNIT WITH GLASS DOOR AND DECORATED DOOR WITH LEAF DECORATION W 60 H 120	1.479
1	DCC2621K	PENSILE ANTA DECORATA CON DECORO FOGLIA L 60 H 60 WALL UNIT WITH DOOR WITH LEAF DECORATION W 60 H 60	1.191
1	DCC2161K	PENSILE VASISTAS ANTA VETRO L 120 WALL UNIT WITH GLASS LIFT-UP DOOR W 120	1.203
1	PFC3521K	MENSOLA L 120 SHELF W 120	271
DCC0156K PREZZO TOTALE COMPOSIZIONE TOTAL PRICE FOR COMPOSITION			7.282



L. W. 240
P. D. 40/50

COMPOSIZIONE 158

COMPOSITION 158

PAG. 56 CATALOGO "PROPOSTE ARREDATIVE"
PAGE 56 "FURNISHING SOLUTIONS" CATALOGUE

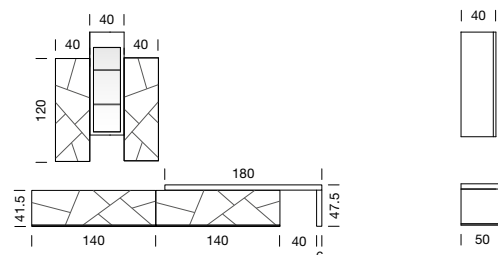
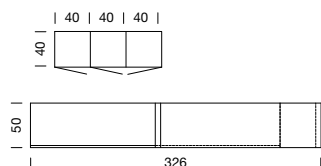

			NOCE FRASSINO
2	DCC1484K	BASE A TERRA CON CESTONE DECORATO L 140 P 50 FLOOR-STANDING BASE UNIT WITH DECORATED BASKET W 140 D 50	3.704
1	DCC3031K	MENSOLONE L 180 P 50 LARGE SHELF W 180 D 50	553
1	DCC3511K	PIEDISTALLO PER MENSOLONE H 41.5 P 50 PEDESTAL FOR LARGE SHELF H 41.5 D 50	248
2	DCC2372K	PENSILE ANTA DECORATA L 40 H 120 (SX) WALL UNIT WITH DECORATED DOOR W 40 H 120 (LH)	1.473
2	DCC2371K	PENSILE ANTA DECORATA L 40 H 120 (DX) WALL UNIT WITH DECORATED DOOR W 40 H 120 (RH)	1.473
1	DCC2342K	PENSILE ANTA VETRO L 40 H 120 WALL UNIT WITH GLASS DOOR LH W 40 H 120	1.155
DCC0158K PREZZO TOTALE COMPOSIZIONE TOTAL PRICE FOR COMPOSITION			8.606

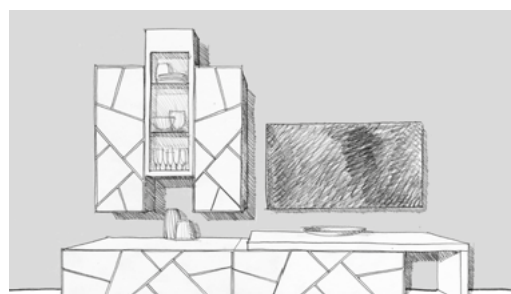

L. W. 326
P. D. 40/50

COMPOSIZIONI A CATALOGO CATALOGUE COMPOSITIONS

POSSIBILITÀ DI FRONTALE DIVERSO DALLA SCOCCA, SPECIFICARE LA FINITURA SCELTA
IN CASE OF FRONT DIFFERENT FROM THE CARCASE CONSIDER THE HIGHER PRICE OF THE CHOSEN FINISH

COMPOSIZIONE 162

COMPOSITION 162

PAG. 57 CATALOGO "PROPOSTE ARREDATIVE"
PAGE 57 "FURNISHING SOLUTIONS" CATALOGUE

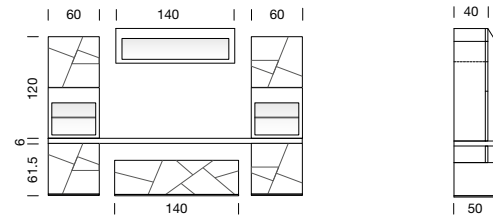
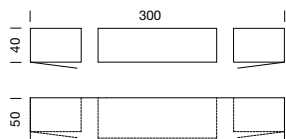

		NOCE FRASSINO
1	DCC1484K BASE A TERRA CON CESTONE DECORATO L 140 P 50 FLOOR-STANDING BASE UNIT WITH DECORATED BASKET W 140 D 50	1.852
1	DCC3071K MENSOLONE L 300 P 50 LARGE SHELF W 300 D 50	890
1	DCC3131K BASE A TERRA ANTA DECORATA L 60 H 61,5 P 40 (SX) BASE UNIT WITH DECORATED DOOR LH W 60 H 61.5 (LH)	1.136
1	DCC3531K BASE A TERRA ANTA DECORATA L 60 H 61,5 P 40 (DX) BASE UNIT WITH DECORATED DOOR LH W 60 H 61.5 (RH)	1.136
1	DCC2562K PENSILE ANTA DECORATA E ANTA VETRO L 60 H 120 (SX) WALL UNIT WITH DECORATED DOOR AND GLASS DOOR W 60 H 120 (LH)	1.479
1	DCC2561K PENSILE ANTA DECORATA E ANTA VETRO L 60 H 120 (DX) WALL UNIT WITH DECORATED DOOR AND GLASS DOOR W 60 H 120 (RH)	1.479
1	DCC2164K PENSILE VASISTAS ANTA VETRO L 140 WALL UNIT WITH GLASS LIFT-UP DOOR W 140	1.395
DCC0162K PREZZO TOTALE COMPOSIZIONE TOTAL PRICE FOR COMPOSITION		9.367



L. W. 300
P. D. 40/50

COMPOSIZIONE 164

COMPOSITION 164

PAG. 58 CATALOGO "PROPOSTE ARREDATIVE"
PAGE 58 "FURNISHING SOLUTIONS" CATALOGUE

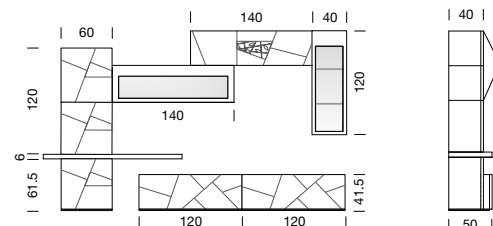
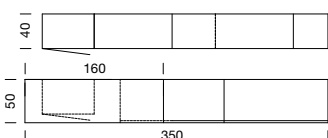

		NOCE FRASSINO
2	DCC1181K BASE A TERRA CON CESTONE DECORATO L 120 P 50 FLOOR-STANDING BASE UNIT WITH DECORATED BASKET W 120 D 50	3.138
1	DCC3131K BASE A TERRA ANTA DECORATA L 60 H 61,5 P 40 FLOOR-STANDING BASE UNIT WITH DECORATED DOOR W 60 D 40	1.136
1	DCC3031K MENSOLONE L 180 P 50 LARGE SHELF W 180 D 50	553
1	DCC2582K PENSILE 2 ANTE DECORATE L 60 H 120 WALL UNIT WITH 2 DECORATED DOORS W 60 H 120	1.545
1	DCC2114K PENSILE VASISTAS ANTA DECORATA CON DECORO FOGLIA L 140 WALL UNIT WITH LIFT-UP DOOR WITH LEAF DECORATION W 140	1.665
1	DCC2264K PENSILE RIBALTA ANTA VETRO L 140 WALL UNIT WITH GLASS DROP-DOWN DOOR W 140	1.395
1	DCC2341K PENSILE ANTA VETRO L 40 H 120 WALL UNIT WITH GLASS DOOR W 40 H 120	1.155
DCC0164K PREZZO TOTALE COMPOSIZIONE TOTAL PRICE FOR COMPOSITION		10.587



L. W. 350
P. D. 40/50

COMPOSIZIONE 168

COMPOSITION 168

PAG. 61 CATALOGO "PROPOSTE ARREDATIVE"
PAGE 61 "FURNISHING SOLUTIONS" CATALOGUE

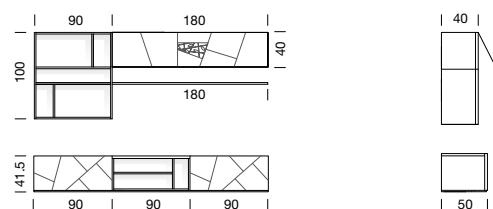

		NOCE FRASSINO
2	DCC1161K BASE A TERRA CON CESTONE DECORATO L 90 P 50 FLOOR-STANDING BASE UNIT WITH DECORATED BASKET W 90 D 50	2.576
1	DCC1231K BASE A TERRA A GIORNO CON RIPIANO LEGNO E DIVISORIO L 90 P 50 OPEN FLOOR-STANDING BASE UNIT WITH WOODEN SHELF AND PARTITION W 90 D 50	903
1	DCC2911K PENSILE A GIORNO L 90 H 100 OPEN WALL UNIT W 90 H 100	1.155
1	DCC2131K PENSILE VASISTAS ANTA LEGNO DECORATA CON DECORO FOGLIA L 180 WALL UNIT WITH WOODEN LIFT-UP DOOR WITH LEAF DECORATION W 180	1.961
1	PFC3531K MENSOLA L 180 SHELF W 180	386
DCC0168K PREZZO TOTALE COMPOSIZIONE TOTAL PRICE FOR COMPOSITION		6.981

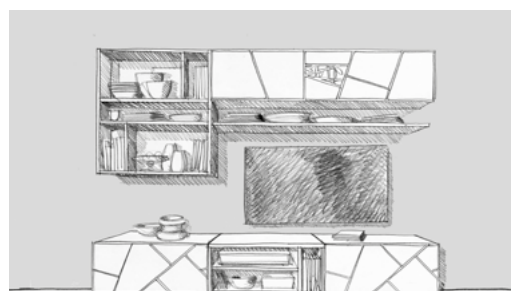

L. W. 270
P. D. 40/50

DECOR SISTEMA COMPONIBILE - MODULAR SYSTEM

COMPOSIZIONI A CATALOGO CATALOGUE COMPOSITIONS

POSSIBILITÀ DI FRONTALE DIVERSO DALLA SCOCCA, SPECIFICARE LA FINITURA SCELTA
IN CASE OF FRONT DIFFERENT FROM THE CARCASE CONSIDER THE HIGHER PRICE OF THE CHOOSEN FINISH

COMPOSIZIONE 170

COMPOSITION 170

PAG. 61 CATALOGO "PROPOSTE ARREDATIVE"
PAGE 61 "FURNISHING SOLUTIONS" CATALOGUE

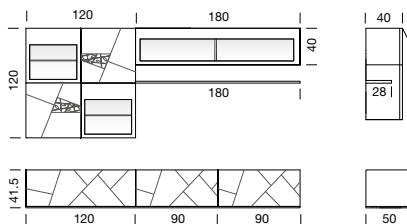
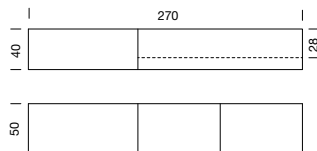

			NOCE FRASSINO
1	DCC1181K	BASE A TERRA CON CESTONE DECORATO L 120 P 50 FLOOR-STANDING BASE UNIT WITH DECORATED BASKET W 120 D 50	1.569
2	DCC1161K	BASE A TERRA CON CESTONE DECORATO L 90 P 50 FLOOR-STANDING BASE UNIT WITH DECORATED BASKET W 90 D 50	2.576
1	DCC2881K	PENSILE 2 ANTE VETRO 2 ANTE DECORATE CON DECORO FOGLIA L 120 H 120 WALL UNIT WITH 2 GLASS DOORS 2 DOORS WITH LEAF DECORATION W 120 H 120	2.393
1	DCC2171K	PENSILE VASISTAS ANTA VETRO L 180 WALL UNIT WITH GLASS LIFT-UP DOOR W 180	1.521
1	PFC3531K	MENSOLA L 180 SHELF W 180	386
DCC0170K PREZZO TOTALE COMPOSIZIONE			8.445
TOTAL PRICE FOR COMPOSITION			



L. W. 270
P. D. 40/50

COMPOSIZIONE 172

COMPOSITION 172

PAG. 62 CATALOGO "PROPOSTE ARREDATIVE"
PAGE 62 "FURNISHING SOLUTIONS" CATALOGUE

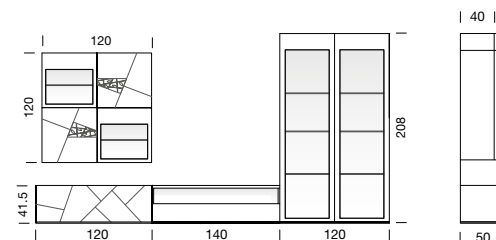
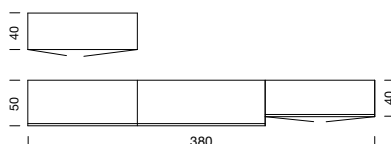

			NOCE FRASSINO
1	DCC1181K	BASE A TERRA CON CESTONE DECORATO L 120 P 50 FLOOR-STANDING BASE UNIT WITH DECORATED BASKET W 120 D 50	1.569
1	DCC1234K	BASE A TERRA CON CASSETTO E VANO A GIORNO L 140 P 50 FLOOR-STANDING BASE UNIT WITH DRAWER AND OPEN COMPARTMENT W 140 D 50	1.557
1	DCC6011K	VETRINA 2 ANTE VETRO L 120 H 208 DISPLAY UNIT WITH 2 GLASS DOORS W 120 H 208	2.892
1	DCC2881K	PENSILE 2 ANTE VETRO 2 ANTE DECORATE CON DECORO FOGLIA L 120 H 120 WALL UNIT WITH 2 GLASS DOORS 2 DOORS WITH LEAF DECORATION W 120 H 120	2.393
DCC0172K PREZZO TOTALE COMPOSIZIONE			8.411
TOTAL PRICE FOR COMPOSITION			



L. W. 380
P. D. 40/50

COMPOSIZIONE 124

COMPOSITION 124

PAG. 46 CATALOGO "PROPOSTE ARREDATIVE"
PAGE 46 "FURNISHING SOLUTIONS" CATALOGUE

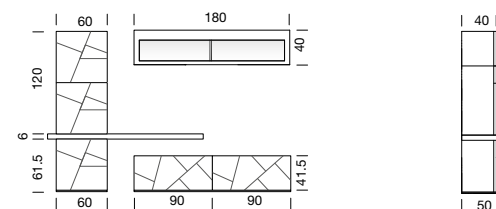
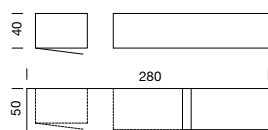

			NOCE FRASSINO
2	DCC1161K	BASE A TERRA CON CESTONE DECORATO L 90 P 50 FLOOR-STANDING BASE UNIT WITH DECORATED BASKET W 90 D 50	2.576
1	DCC3131K	BASE A TERRA ANTA DECORATA L 60 H 61.5 P 40 FLOOR-STANDING BASE UNIT WITH DECORATED DOOR W 60 H 61.5 D 40	1.136
1	DCC3031K	MENSOLONE L 180 P 50 LARGE SHELF W 180 D 50	553
1	DCC2582K	PENSILE 2 ANTE DECORATE L 60 H 120 WALL UNIT WITH 2 DECORATED DOORS W 60 H 120	1.545
1	DCC2171K	PENSILE VASISTAS ANTA VETRO L 180 WALL UNIT WITH GLASS LIFT-UP DOOR W 180	1.521
DCC0124K PREZZO TOTALE COMPOSIZIONE			7.331
TOTAL PRICE FOR COMPOSITION			



L. W. 280
P. D. 40/50

COMPOSIZIONI A CATALOGO CATALOGUE COMPOSITIONS

POSSIBILITÀ DI FRONTALE DIVERSO DALLA SCOCCA, SPECIFICARE LA FINITURA SCELTA
IN CASE OF FRONT DIFFERENT FROM THE CARCASE CONSIDER THE HIGHER PRICE OF THE CHOOSEN FINISH

COMPOSIZIONE 178

COMPOSITION 178

PAG. 64 CATALOGO "PROPOSTE ARREDATIVE"
PAGE 64 "FURNISHING SOLUTIONS" CATALOGUE

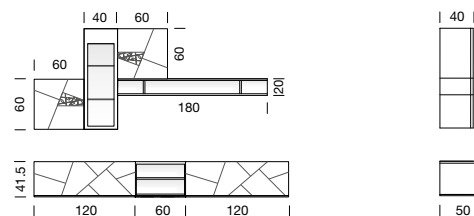
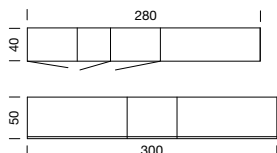

			NOCE FRASSINO
2	DCC1181K	BASE A TERRA CON CESTONE DECORATO L 120 P 50 FLOOR-STANDING BASE UNIT WITH DECORATED BASKET W 120 D 50	3.138
1	DCC1081K	BASE A TERRA A GIORNO CON RIPIANO LEGNO L 60 P 50 OPEN FLOOR-STANDING BASE UNIT WITH WOODEN SHELF W 60 D 50	735
1	DCC2622K	PENSILE ANTA DECORATA CON DECORO FOGLIA L 60 H 60 (SX) WALL UNIT WITH DOOR WITH LEAF DECORATION W 60 H 60 (LH)	1.191
1	DCC2621K	PENSILE ANTA DECORATA CON DECORO FOGLIA L 60 H 60 (DX) WALL UNIT WITH DOOR WITH LEAF DECORATION W 60 H 60 (RH)	1.191
1	DCC2341K	PENSILE ANTA VETRO L 40 H 120 WALL UNIT WITH GLASS DOOR RH W 40 H 120	1.155
1	DCC2951K	PENSILE ORIZZONTALE A GIORNO L 180 H 20 OPEN HORIZONTAL WALL UNIT W 180 H 20	938
DCC0178K PREZZO TOTALE COMPOSIZIONE TOTAL PRICE FOR COMPOSITION			8.348

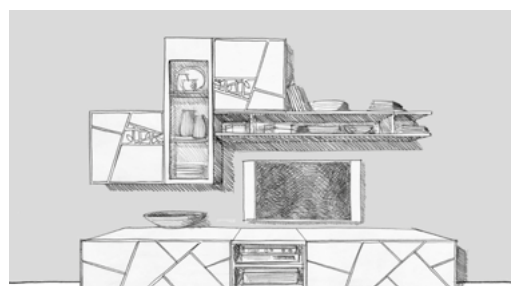

L. W. 300
P. D. 40/50

COMPOSIZIONE 180

COMPOSITION 180

PAG. 65 CATALOGO "PROPOSTE ARREDATIVE"
PAGE 65 "FURNISHING SOLUTIONS" CATALOGUE

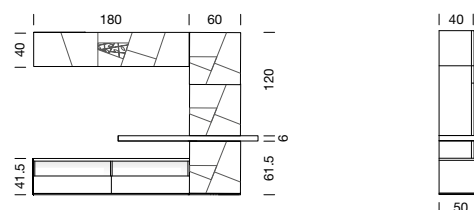
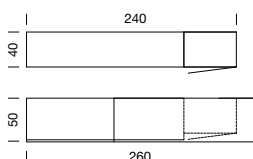

			NOCE FRASSINO
1	DCC1192K	BASE A TERRA 2 CASSETTI E VANI A GIORNO L 180 P 50 FLOOR-STANDING BASE UNIT WITH UNIT WITH 2 DRAWERS AND OPEN COMPARTMENTS W 180 D 50	1.858
1	DCC3531K	BASE A TERRA ANTA DECORATA CON DECORO FOGLIA L 60 H 61,5 P 40 FLOOR-STANDING BASE UNIT WITH DOOR WITH LEAF DECORATION W 60 H 61.5 D 40	1.136
1	DCC3061K	MENSOLEONE L 160 P 50 LARGE SHELF W 160 D 50	511
1	DCC2581K	PENSILE 2 ANTE DECORATE L 60 H 120 WALL UNIT WITH 2 DECORATED DOORS W 60 H 120	1.545
1	DCC2131K	PENSILE VASISTAS ANTA DECORATA CON DECORO FOGLIA L 180 WALL UNIT WITH LIFT-UP DOOR WITH LEAF DECORATION W 180	1.961
DCC0180K PREZZO TOTALE COMPOSIZIONE TOTAL PRICE FOR COMPOSITION			7.011



L. W. 260
P. D. 40/50

COMPOSIZIONE 102

COMPOSITION 102

PAG. 67 CATALOGO "PROPOSTE ARREDATIVE"
PAGE 67 "FURNISHING SOLUTIONS" CATALOGUE

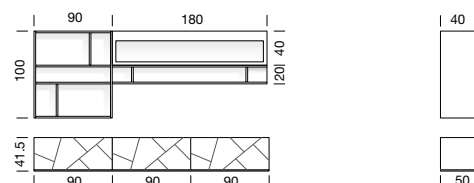
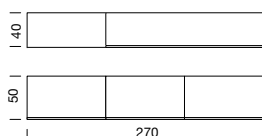

			NOCE FRASSINO
3	DCC1161K	BASE A TERRA CON CESTONE DECORATO L 90 P 50 OPEN WALL UNIT W 90 H 100	3.864
1	DCC2911K	PENSILE A GIORNO L 90 H 100 OPEN WALL UNIT W 90 H 100	1.155
1	DCC2171K	PENSILE VASISTAS ANTA VETRO L 180 HORIZONTAL WALL UNIT WITH GLASS LIFT-UP DOOR W 180	1.521
1	DCC2951K	PENSILE A GIORNO L 180 H 20 OPEN WALL UNIT W 180 H 20	938
DCC0102K PREZZO TOTALE COMPOSIZIONE TOTAL PRICE FOR COMPOSITION			7.478

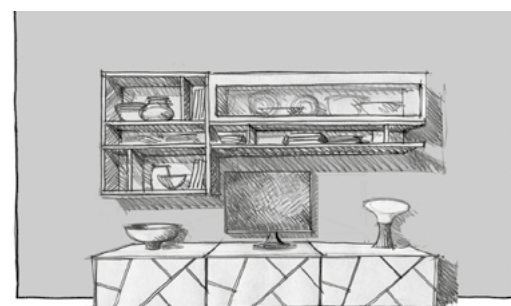

L. W. 270
P. D. 40/50

DECOR SISTEMA COMPONIBILE - MODULAR SYSTEM

COMPOSIZIONI A CATALOGO CATALOGUE COMPOSITIONS

POSSIBILITÀ DI FRONTALE DIVERSO DALLA SCOCCA, SPECIFICARE LA FINITURA SCELTA
IN CASE OF FRONT DIFFERENT FROM THE CARCASE CONSIDER THE HIGHER PRICE OF THE CHOOSEN FINISH

COMPOSIZIONE 103

COMPOSITION 103

PAG. 68 CATALOGO "PROPOSTE ARREDATIVE"
PAGE 68 "FURNISHING SOLUTIONS" CATALOGUE

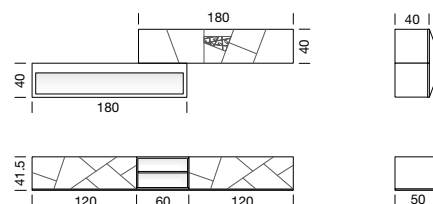
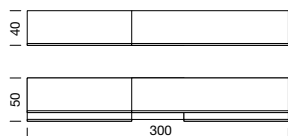

			NOCE FRASSINO
2	DCC1181K	BASE A TERRA CON CESTONE DECORATO L 120 P 50 FLOOR-STANDING BASE UNIT WITH DECORATED BASKET W 120 D 50	3.138
1	DCC1081K	BASE A GIORNO A TERRA CON RIPIANO LEGNO L 60 P 50 OPEN FLOOR-STANDING BASE UNIT WITH WOODEN SHELF W 60 D 50	735
1	DCC2131K	PENSILE VASISTAS ANTA DECORATA CON DECORO FOGLIA L 180 HORIZONTAL WALL UNIT WITH LEAF DECORATION LIFT-UP DOOR W 180	1.961
1	DCC2271K	PENSILE RIBALTA ANTA VETRO L 180 HORIZONTAL WALL UNIT WITH GLASS DROP-DOWN DOOR W 180	1.521
DCC0103K PREZZO TOTALE COMPOSIZIONE TOTAL PRICE FOR COMPOSITION			7.355

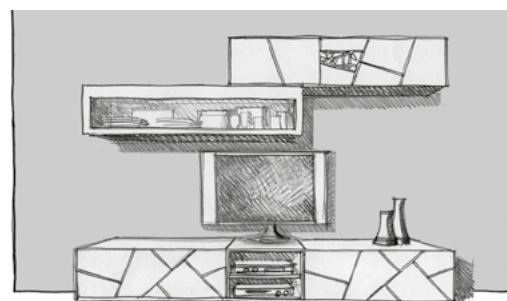

L. W. 300
P. D. 40/50

COMPOSIZIONE 105

COMPOSITION 105

PAG. 69 CATALOGO "PROPOSTE ARREDATIVE"
PAGE 69 "FURNISHING SOLUTIONS" CATALOGUE

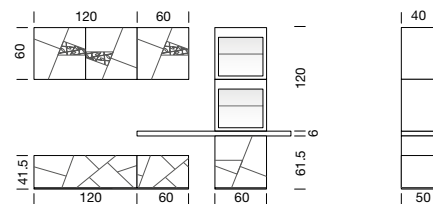
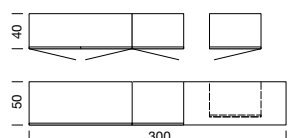

			NOCE FRASSINO
1	DCC1181K	BASE A TERRA CON CESTONE DECORATO L 120 P 50 FLOOR-STANDING BASE UNIT WITH DECORATED BASKET W 120 D 50	1.569
1	DCC1141K	BASE A TERRA CON CESTONE DECORATO L 60 P 50 FLOOR-STANDING BASE UNIT WITH DECORATED BASKET W 60 D 50	1.041
1	DCC3531K	BASE ANTA DECORATA L 60 H 61,5 P 40 FLOOR-STANDING BASE UNIT WITH DECORATED DOOR W 60 H 61.5 D 40	1.136
1	DCC2981K	PENSILE 2 ANTE DECORATE CON DECORO FOGLIA L 120 H 60 WALL UNIT WITH 2 DOORS WITH LEAF DECORATION W 120 H 60	1.803
1	DCC2621K	PENSILE ANTA DECORATA CON DECORO FOGLIA L 60 H 60 WALL UNIT WITH 1 DOOR WITH LEAF DECORATION W 60 H 60	1.191
1	DCC2431K	PENSILE VERTICALE 2 ANTE VETRO L 60 H 120 VERTICAL WALL UNIT WITH 2 GLASS DOORS W 60 H 120	1.395
1	DCC3031K	MENSOLONE L 180 P 50 LARGE SHELF W 180 D 50	553
DCC0105K PREZZO TOTALE COMPOSIZIONE TOTAL PRICE FOR COMPOSITION			8.688



L. W. 300
P. D. 40/50

COMPOSIZIONE 106

COMPOSITION 106

PAG. 70 CATALOGO "PROPOSTE ARREDATIVE"
PAGE 70 "FURNISHING SOLUTIONS" CATALOGUE

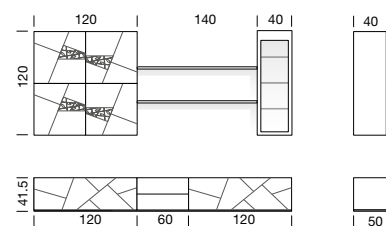
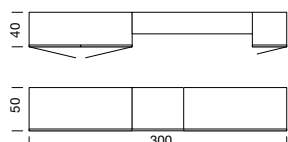

			NOCE FRASSINO
2	DCC1181K	BASE A TERRA CON CESTONE DECORATO L 120 P 50 FLOOR-STANDING BASE UNIT WITH DECORATED BASKET W 120 D 50	3.138
1	DCC1143K	BASE A TERRA CON 2 CASSETTI L 60 P 50 FLOOR-STANDING BASE UNIT WITH 2 DRAWERS W 60 D 50	1.353
1	DCC2341K	PENSILE ANTA VETRO L 40 H 120 VERTICAL WALL UNIT WITH GLASS DOOR W 40 H 120	1.155
1	DCC2781K	PENSILE 4 ANTE DECORATE CON DECORO FOGLIA L 120 H 120 WALL UNIT WITH 4 DOORS WITH LEAF DECORATION W 120 H 120	2.525
2	PFC3541K	MENSOLA L 140 SHLEF W 140	616
DCC0106K PREZZO TOTALE COMPOSIZIONE TOTAL PRICE FOR COMPOSITION			8.787

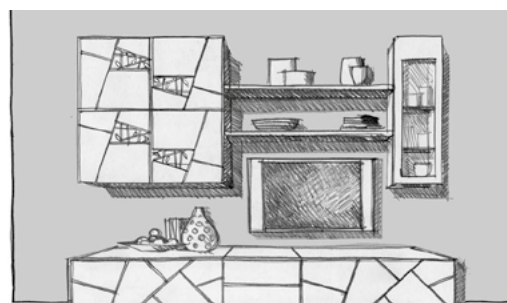

L. W. 300
P. D. 40/50

COMPOSIZIONI A CATALOGO CATALOGUE COMPOSITIONS

POSSIBILITÀ DI FRONTALE DIVERSO DALLA SCOCCA, SPECIFICARE LA FINITURA SCELTA
IN CASE OF FRONT DIFFERENT FROM THE CARCASE CONSIDER THE HIGHER PRICE OF THE CHOOSEN FINISH

COMPOSIZIONE 107 COMPOSITION 107

PAG. 15-16 CATALOGO "MODOZINE" E
PAG. 68-69 CATALOGO "DECOR NEW"
PAGE 15-16 "MODOZINE" AND
PAGE 68-69 "DECOR NEW" CATALOGUE

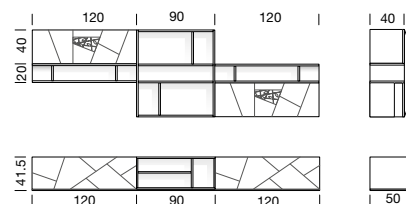
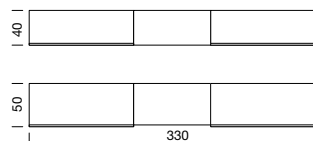

			NOCE FRASSINO
2	DCC1181K	BASE A TERRA CON CESTONE DECORATO L 120 P 50 FLOOR-STANDING BASE UNIT WITH DECORATED BASKET W 120 D 50	3.138
1	DCC1231K	BASE A GIORNO A TERRA CON RIPIANO LEGNO L 90 P 50 OPEN FLOOR-STANDING BASE UNIT WITH WOODEN SHELF W 90 D 50	903
1	DCC2911K	PENSILE A GIORNO L 90 H 100 OPEN WALL UNIT W 90 H 100	1.155
1	DCC2121K	PENSILE VASISTAS ANTA DECORATA CON DECORO FOGLIA L 120 HORIZONTAL WALL UNIT WITH LEAF DECORATION LIFT-UP DOOR W 120	1.564
1	DCC2221K	PENSILE RIBALTA ANTA DECORATA CON DECORO FOGLIA L 120 HORIZONTAL WALL UNIT WITH LEAF DECORATION DROP-DOWN DOOR W 120	1.564
2	DCC2941K	PENSILE A GIORNO L 120 H 20 2 OPEN WALL UNITS W 120 H 20	1.470
DCC0107K PREZZO TOTALE COMPOSIZIONE TOTAL PRICE FOR COMPOSITION			9.794



L. W. 330
P. D. 40/50

COMPOSIZIONE 112 COMPOSITION 112

PAG. 73 CATALOGO "PROPOSTE ARREDATIVE"
PAGE 73 "FURNISHING SOLUTIONS" CATALOGUE

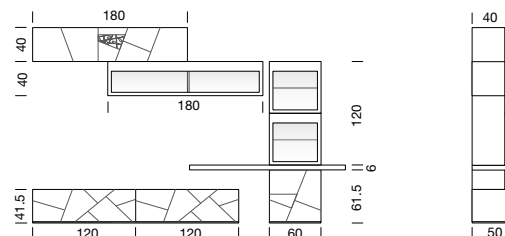
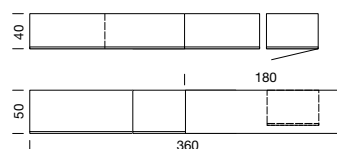

			NOCE FRASSINO
2	DCC1181K	BASE A TERRA CON CESTONE DECORATO L 120 P 50 FLOOR-STANDING BASE UNIT WITH DECORATED BASKET W 120 D 50	3.138
1	DCC3531K	BASE A TERRA ANTA DECORATA L 60 H 61,5 P 40 FLOOR-STANDING BASE UNIT WITH DECORATED DOOR W 60 H 61.5 D 40	1.136
1	DCC2131K	PENSILE VASISTAS ANTA DECORATA CON DECORO FOGLIA L 180 WALL UNIT WITH LEAF DECORATION LIFT-UP DOOR W 180	1.961
1	DCC2271K	PENSILE RIBALTA ANTA VETRO L 180 WALL UNIT WITH GLASS DROP-DOWN DOOR W 180	1.521
1	DCC2431K	PENSILE 2 ANTE VETRO L 60 H 120 WALL UNIT WITH 2 GLASS DOORS W 60 H 120	1.395
1	DCC3031K	MENSOLONE L 180 P 50 LARGE SHELF W 180 D 50	553
DCC0112K PREZZO TOTALE COMPOSIZIONE TOTAL PRICE FOR COMPOSITION			9.704

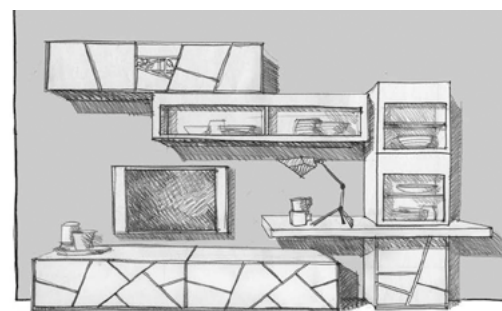

L. W. 360
P. D. 40/50

COMPOSIZIONE 112/A COMPOSITION 112/A

PAG. 32-33 CATALOGO "MODOZINE" E
AG. 102-103 CATALOGO "DECOR NEW"
PAGE 32-33 "MODOZINE" AND
PAGE 102-103 "DECOR NEW" CATALOGUE

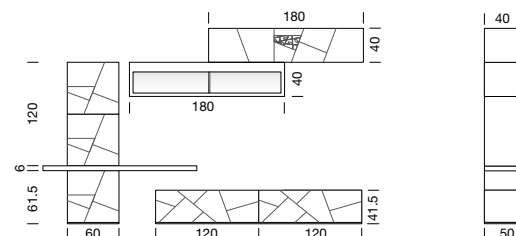
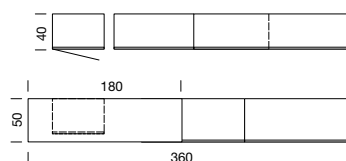

			NOCE FRASSINO
2	DCC1181K	BASE A TERRA CON CESTONE DECORATO L 120 P 50 FLOOR-STANDING BASE UNIT WITH DECORATED BASKET W 120 D 50	3.138
1	DCC3131K	BASE A TERRA ANTA DECORATA L 60 H 61,5 P 40 FLOOR-STANDING BASE UNIT WITH DECORATED DOOR W 60 H 61.5 D 40	1.136
1	DCC2131K	PENSILE VASISTAS ANTA DECORATA CON DECORO FOGLIA L 180 HORIZONTAL WALL UNIT WITH LEAF DECORATION LIFT-UP DOOR W 180	1.961
1	DCC2271K	PENSILE RIBALTA ANTA VETRO L 180 HORIZONTAL WALL UNIT WITH DECORATED DROP-DOWN DOOR W 180	1.521
1	DCC2582K	PENSILE 2 ANTE DECORATE L 60 H 120 WALL UNIT WITH 2 DECORATED DOORS W 60 H 120	1.545
1	DCC3031K	MENSOLONE L 180 P 50 LARGE SHELF W 180 D 50	553
DCC112K PREZZO TOTALE COMPOSIZIONE TOTAL PRICE FOR COMPOSITION			9.854



L. W. 360
P. D. 40/50

DECOR SISTEMA COMPONIBILE - MODULAR SYSTEM

COMPOSIZIONI A CATALOGO CATALOGUE COMPOSITIONS

POSSIBILITÀ DI FRONTALE DIVERSO DALLA SCOCCA, SPECIFICARE LA FINITURA SCELTA
IN CASE OF FRONT DIFFERENT FROM THE CARCASE CONSIDER THE HIGHER PRICE OF THE CHOSEN FINISH

COMPOSIZIONE 155

COMPOSITION 155

AG. 70-71 CATALOGO "DECOR NEW"

PAGE 70-71 "DECOR NEW" CATALOGUE

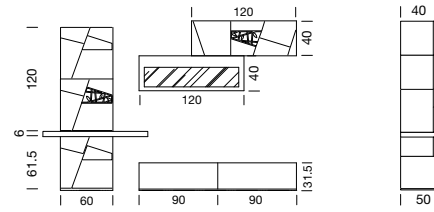
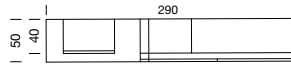

		NOCE FRASSINO
1	DCC1651K BASE A TERRA CON 2 CASSETTI L 180 H. 31,5 P 50 FLOOR-STANDING BASE UNIT WITH 2 DRAWERS W 180 H. 31.5 D 50	1.585
1	DCC3131K BASE ANTA DECORATA L 60 H 61,5 P 40 FLOOR-STANDING BASE UNIT WITH DECORATED DOOR W 60 H 61.5 D 40	1.136
1	DCC3011K MENSOLONE L 90 P 50 LARGE SHELF W 90 D 50	319
1	DCC2582K PENSILE 2 ANTE DECORATE CON DECORO FOGLIA L 60 H 120 WALL UNIT WITH 2 DOORS WITH LEAF DECORATION W 60 H 120	1.545
1	DCC2121K PENSILE VASISTAS ANTA DECORATA CON DECORO FOGLIA L 120 WALL UNIT WITH LEAF DECORATION LIFT-UP DOOR W 120	1.564
1	DCC2261K PENSILE RIBALTA ANTA VETRO L 120 WALL UNIT WITH GLASS DROP-DOWN DOOR W 120	1.203
DCC0115K PREZZO TOTALE COMPOSIZIONE TOTAL PRICE FOR COMPOSITION		5.807



L. W. 300
P. D. 40/50

COMPOSIZIONE 113

COMPOSITION 113

PAG. 74 CATALOGO "PROPOSTE ARREDATIVE"

PAGE 74 "FURNISHING SOLUTIONS" CATALOGUE

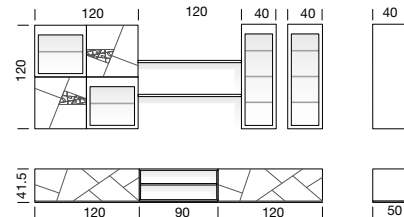
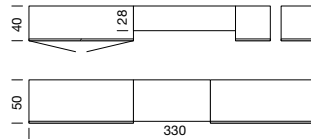

		NOCE FRASSINO
2	DCC1181K BASE A TERRA CON CESTONE DECORATO L 120 P 50 FLOOR-STANDING BASE UNIT WITH DECORATED BASKET W 120 D 50	3.138
1	DCC1101K BASE A TERRA A GIORNO CON RIPIANO LEGNO L 90 P 50 OPEN FLOOR-STANDING BASE UNIT WITH WOODEN SHELF W 90 D 50	848
1	DCC2881K PENSILE 2 ANTE VETRO 2 ANTE DECORATE CON DECORO FOGLIA L 120 H 120 WALL UNIT WITH 2 GLASS DOORS AND 2 DOORS WITH LEAF DECORATION W 120 H 120	2.393
2	DCC2341K PENSILE ANTA VETRO L 40 H 120 WALL UNITS WITH GLASS DOOR W 40 H 120	2.310
2	PFC3521K MENSOLA L 120 SHELVES W 120	542
DCC0113K PREZZO TOTALE COMPOSIZIONE TOTAL PRICE FOR COMPOSITION		9.231

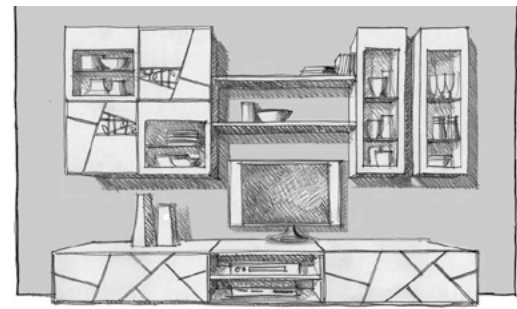

L. W. 330
P. D. 40/50

COMPOSIZIONE 114

COMPOSITION 114

PAG. 75 CATALOGO "PROPOSTE ARREDATIVE"

PAGE 75 "FURNISHING SOLUTIONS" CATALOGUE

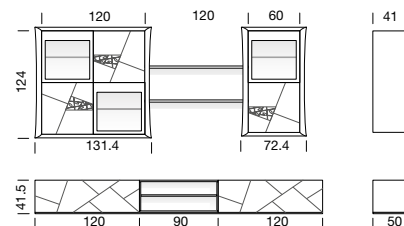
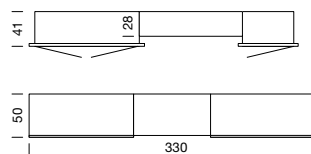

		NOCE FRASSINO
2	DCC1181K BASE A TERRA CON CESTONE DECORATO L 120 P 50 FLOOR-STANDING BASE UNIT WITH DECORATED BASKET W 120 D 50	3.138
1	DCC1101K BASE A TERRA A GIORNO CON RIPIANO LEGNO L 90 P 50 OPEN FLOOR-STANDING BASE UNIT WITH WOODEN SHELF W 90 D 50	848
1	DCC2891K PENSILE 2 ANTE VETRO 2 ANTE DECORATE CON DECORO FOGLIA E CORNICE PERIMETRALE L 131,4 H 124,4 WALL UNIT WITH PERIMETRAL FRAME WITH 2 GLASS DOORS 2 LEAF DECORATION DOORS W 131.4 H 124.4	2.514
1	DCC2571K PENSILE ANTA VETRO E ANTA DECORATA CON DECORO FOGLIA E CORNICE PERIMETRALE L 72,4 H 124,4 WALL UNIT WITH PERIMETRAL FRAME WITH GLASS DOOR AND LEAF DECORATION DOOR W 72.4 H 124.4	1.587
2	PFC3521K MENSOLA L 120 SHELVES W 120	542
DCC0114K PREZZO TOTALE COMPOSIZIONE TOTAL PRICE FOR COMPOSITION		8.629

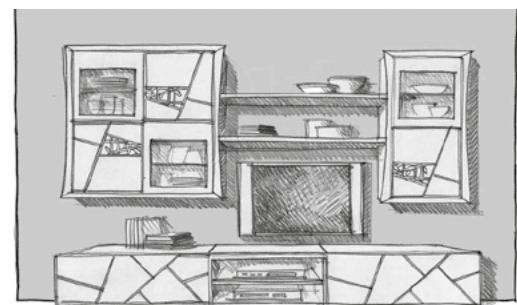

L. W. 330
P. D. 41/50

DECOR SISTEMA PARETE

DECOR WALL SYSTEM

CARATTERISTICHE TECNICHE E PARTICOLARITÀ DI UTILIZZO TECHNICAL CHARACTERISTICS AND PARTICULAR USE	118
ACCESSORI OPTIONAL OPTIONAL ACCESSORIES	123
COMPONENTI STRUTTURALI STRUCTURAL COMPONENTS	124
FRONTALI DECOR DECOR FRONTS	129
MODULI A COLONNA H. 226.5 – P. 40 TALL UNIT MODULES H. 226.5 – D. 40	130
COMPOSIZIONI HOME THEATRE H. 226.5 – P. 40/50 HOME THEATRE COMPOSITIONS H. 226.5 – D. 40/50	140
COMPOSIZIONI A CATALOGO CATALOGUE COMPOSITIONS	142

DECOR SISTEMA PARETE - WALL SYSTEM

CARATTERISTICHE TECNICHE E PARTICOLARITÀ DI UTILIZZO

TECHNICAL CHARACTERISTICS AND PARTICULAR USE

ANTE DOORS

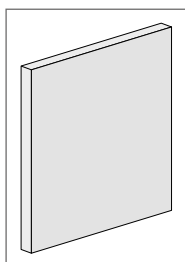

ANTA LEGNO
WOODEN DOOR

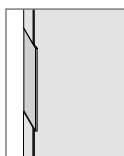

MANIGLIA MONDRIAN
MONDRIAN HANDLE

ANTA LEGNO PANNELLO DI LISTELLARE IMPIALLACCIATO NOCE O FRASSINO SPAZZOLATO SP. CM. 2.5 VERNICIATO O LACCATO PORO APERTO.

MANIGLIA PUSH-PULL O MANIGLIA MONDRIAN FINITURA ABBINATA ALL'ANTA.

CERNIERE AMMORTIZZATE DI SERIE

WOODEN DOOR BLOCKBOARD PANEL VENEERED IN WALNUT OR BRUSHED ASHWOOD TH. CM. 2.5 PAINTED OR OPEN PORE LACQUERED.

HANDLE PUSH-PULL OR MONDRIAN HANDLE. SAME FINISH AS THE DOOR.

STANDARD SOFT-CLOSE HINGES

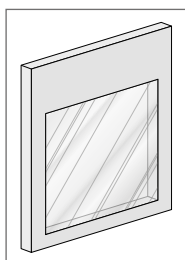

ANTA VETRO
GLASS DOOR



MANIGLIA MONDRIAN
MONDRIAN HANDLE

ANTA VETRO PANNELLO DI LISTELLARE IMPIALLACCIATO NOCE O FRASSINO SPAZZOLATO SP. CM. 2.5 VERNICIATO O LACCATO PORO APERTO. VETRO FLOAT SP. CM. 0.4.

MANIGLIA PUSH-PULL O MANIGLIA MONDRIAN FINITURA ABBINATA ALL'ANTA.

CERNIERE AMMORTIZZATE DI SERIE

GLASS DOOR BLOCKBOARD PANEL VENEERED IN WALNUT OR BRUSHED ASHWOOD TH. CM. 2.5 PAINTED OR OPEN PORE LACQUERED. FLOAT GLASS TH. CM. 0.4.

HANDLE PUSH-PULL OR MONDRIAN HANDLE. SAME FINISH AS THE DOOR.

STANDARD SOFT-CLOSE HINGES

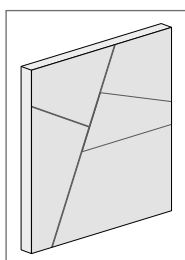

ANTA SENZA "DECORO FOGLIA"
DOOR WITHOUT "LEAF DECORATION"

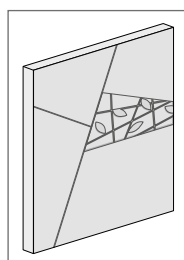

ANTA CON "DECORO FOGLIA"
DOOR WITH "LEAF DECORATION"

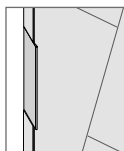

MANIGLIA MONDRIAN
MONDRIAN HANDLE

ANTA DECORATA MASSELLO DI TOULUPIER O FRASSINO SPAZZOLATO SP. CM. 2.5 E PANNELLO DECORATIVO IN MULTISTRATO IMPIALLACCIATO IN NOCE O FRASSINO SPAZZOLATO SP. CM. 0.5, VERNICIATO O LACCATO A PORO APERTO.

MANIGLIA PUSH-PULL O MANIGLIA MONDRIAN FINITURA ABBINATA ALL'ANTA.

CERNIERE AMMORTIZZATE DI SERIE

DECORATED DOOR TOULUPIER SOLID WOOD OR BRUSHED ASHWOOD TH. CM. 2.5 AND MULTILAYER DECORATIVE PANEL VENEERED IN WALNUT OR BRUSHED ASHWOOD TH. CM. 0.5, PAINTED OR OPEN PORE LACQUERED.

HANDLE PUSH-PULL OR MONDRIAN HANDLE. SAME FINISH AS THE DOOR.

STANDARD SOFT-CLOSE HINGES

CASSETTI E CESTONI DRAWERS AND BASKETS

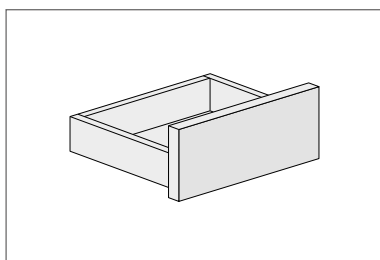

CASSETTO LEGNO
WOODEN DRAWER

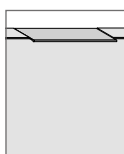

MANIGLIA MONDRIAN
MONDRIAN HANDLE

FRONTALE CASSETTO PANNELLO DI LISTELLARE IMPIALLACCIATO NOCE O FRASSINO SPAZZOLATO SP. CM. 2.5, VERNICIATO O LACCATO A PORO APERTO.

STRUTTURA CASSETTO PANNELLO DI MULTISTRATO BETULLA SP. CM. 1.5 CON INCASTRI A CODA DI RONDINE, VERNICIATO TINTA ACACIA.

GUIDE CASSETTO REGOLABILI IN ALTEZZA E CON RICHIAMO AUTOMATICO AMMORTIZZATO

MANIGLIA CASSETTO PUSH-PULL O MANIGLIA MONDRIAN IN FINITURA ABBINATA AL CASSETTO.

DRAWER FRONT BLOCKBOARD PANEL VENEERED IN WALNUT OR BRUSHED ASHWOOD TH. CM. 2.5, OPEN PORE LACQUERED OR PAINTED.

DRAWER STRUCTURE BIRCH MULTILAYER PANEL TH. CM. 1.5 WITH DOVETAIL JOINTS ACACIA STAINED PAINTED.

DRAWER GUIDES ADJUSTABLE IN HEIGHT AND SOFT-CLOSE SELF-CLOSING MECHANISM

DRAWER HANDLE PUSH-PULL OR MONDRIAN HANDLE IN THE SAME FINISH AS THE DRAWER.

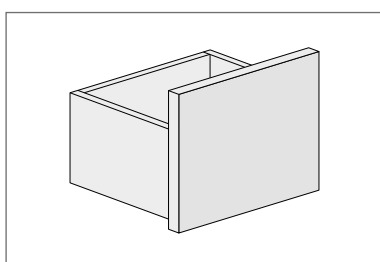

CESTONE LEGNO
WOODEN BASKET

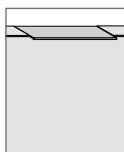

MANIGLIA MONDRIAN
MONDRIAN HANDLE

FRONTALE CESTONE PANNELLO DI LISTELLARE IMPIALLACCIATO NOCE O FRASSINO SPAZZOLATO SP. CM. 2.5 VERNICIATO O LACCATO A PORO APERTO.

STRUTTURA CESTONE PANNELLO DI MULTISTRATO BETULLA SPESSORE CM. 1.5 CON INCASTRI A CODA DI RONDINE VERNICIATO TINTA ACACIA.

GUIDE CASSETTO REGOLABILI IN ALTEZZA E CON RICHIAMO AUTOMATICO AMMORTIZZATO

MANIGLIA CESTONE PUSH-PULL O MANIGLIA MONDRIAN IN FINITURA ABBINATA AL FRONTALE CESTONE.

BASKET FRONT BLOCKBOARD PANEL VENEERED IN WALNUT OR BRUSHED ASHWOOD TH. CM. 2.5 OPEN PORE LACQUERED OR PAINTED.

BASKET STRUCTURE BIRCH MULTILAYER PANEL TH. CM. 1.5 WITH DOVETAIL JOINTS ACACIA STAINED PAINTED.

DRAWER GUIDES ADJUSTABLE IN HEIGHT AND SOFT-CLOSE SELF-CLOSING MECHANISM

BASKET HANDLE PUSH-PULL OR MONDRIAN HANDLE IN THE SAME FINISH AS THE BASKET FRONT.

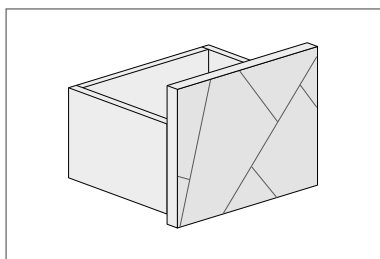

CESTONE DECORATO
DECORATED BASKET

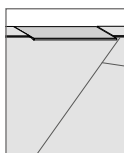

MANIGLIA MONDRIAN
MONDRIAN HANDLE

FRONTALE CESTONE DECORATO LISTELLARE IMPIALLACCIATO IN NOCE O FRASSINO SPAZZOLATO SP. CM. 2.5 E PANNELLO DECORATIVO DI MDF IMPIALLACCIATO IN NOCE O FRASSINO SPAZZOLATO SP. CM. 0.4 VERNICIATO O LACCATO A PORO APERTO.

STRUTTURA CESTONE DECORATO PANNELLO DI MULTISTRATO BETULLA SP. CM. 1.5 CON INCASTRI A CODA DI RONDINE VERNICIATO TINTA ACACIA.

GUIDE CASSETTO REGOLABILI IN ALTEZZA E CON RICHIAMO AUTOMATICO AMMORTIZZATO

MANIGLIA CESTONE PUSH-PULL O MANIGLIA MONDRIAN IN FINITURA ABBINATA AL FRONTALE CESTONE.

DECORATED BASKET FRONT BLOCKBOARD VENEERED IN WALNUT OR BRUSHED ASHWOOD TH. CM. 2.5 AND MDF DECORATIVE PANEL VENEERED IN WALNUT OR BRUSHED ASHWOOD TH. CM. 0.4 PAINTED OR OPEN PORE LACQUERED.

STRUCTURE FOR DECORATED BASKET BIRCH MULTILAYER PANEL TH. CM. 1.5 WITH DOVETAIL JOINTS ACACIA STAINED PAINTED.

DRAWER GUIDES ADJUSTABLE IN HEIGHT AND SOFT-CLOSE SELF-CLOSING MECHANISM

BASKET HANDLE PUSH-PULL OR MONDRIAN HANDLE IN THE SAME FINISH AS THE BASKET FRONT.

COMPONENTI PARETE A TERRA E IN APPOGGIO "HOME THEATRE"

FLOOR-STANDING AND "HOME THEATRE" RAISED COMPONENTS

PARETE A TERRA

FLOOR-STANDING PANEL

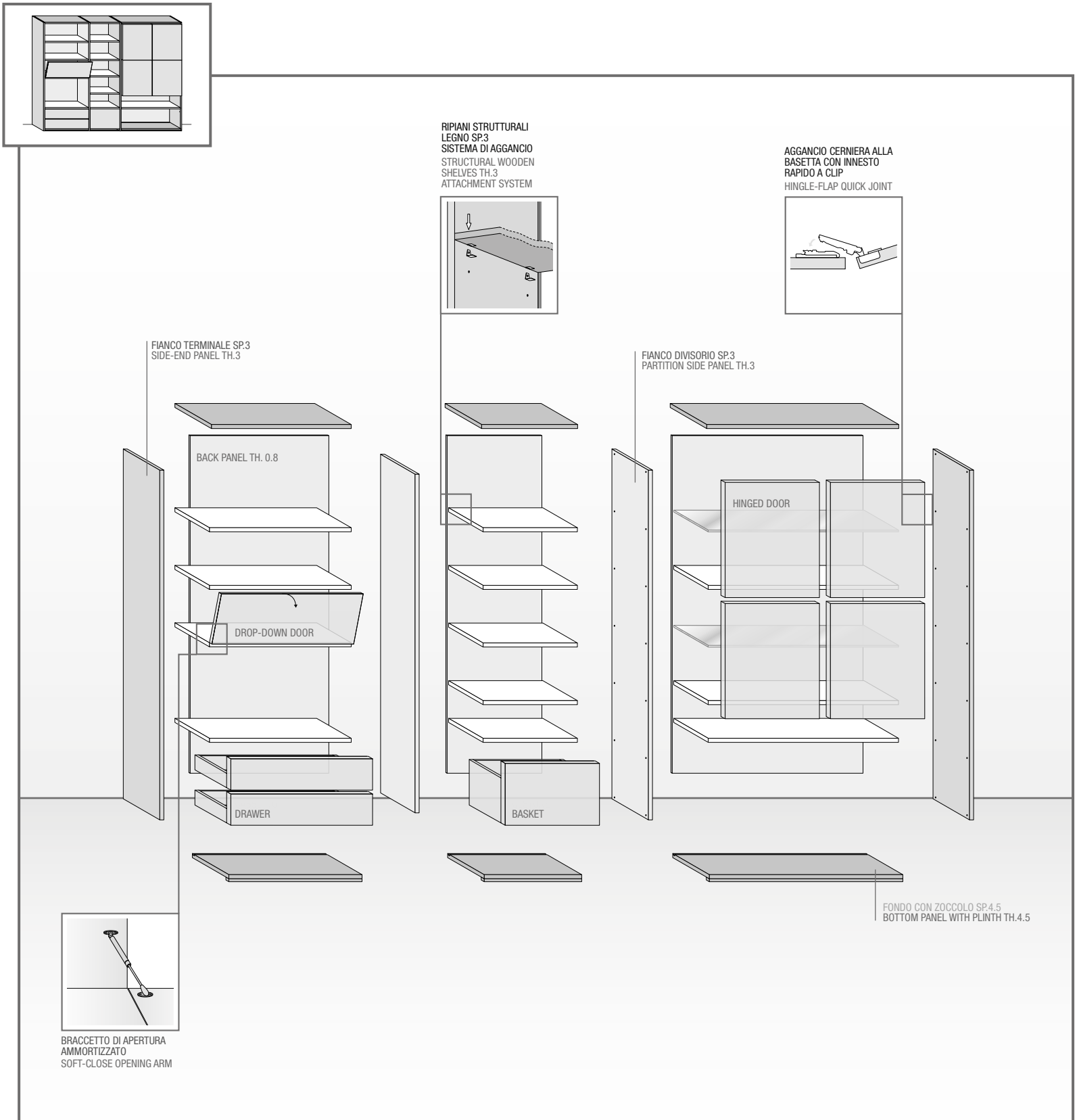

FRONTALI DECOR

DECOR FRONTS

ANTE DOORS

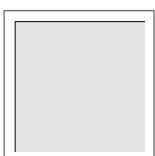

**LEGNO
(BATTENTE/VASISTAS/
RIBALTA)**
WOOD
(HINGED/LIFT-UP/DROP-
DOWN)

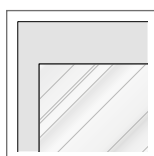

**VETRO
(BATTENTE/VASISTAS/
RIBALTA)**
GLASS
(HINGED/LIFT-UP/DROP-
DOWN)

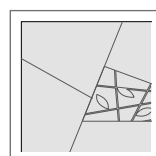

**DECORATO
(BATTENTE/VASISTAS/
RIBALTA)**
DECORATED
(HINGED/LIFT-UP/DROP-
DOWN)

CASSETTI DRAWERS

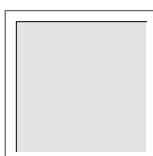

**LEGNO
WOOD**

CESTONI BASKETS

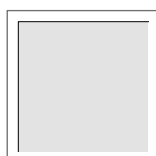

**LEGNO
WOOD**

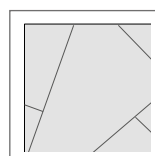

**DECORATO
DECORATED**

DECOR SISTEMA PARETE - WALL SYSTEM

CARATTERISTICHE TECNICHE E PARTICOLARITÀ DI UTILIZZO

TECHNICAL CHARACTERISTICS AND PARTICULAR USE

ASSEMBLAGGIO PARETE

WALL ASSEMBLY

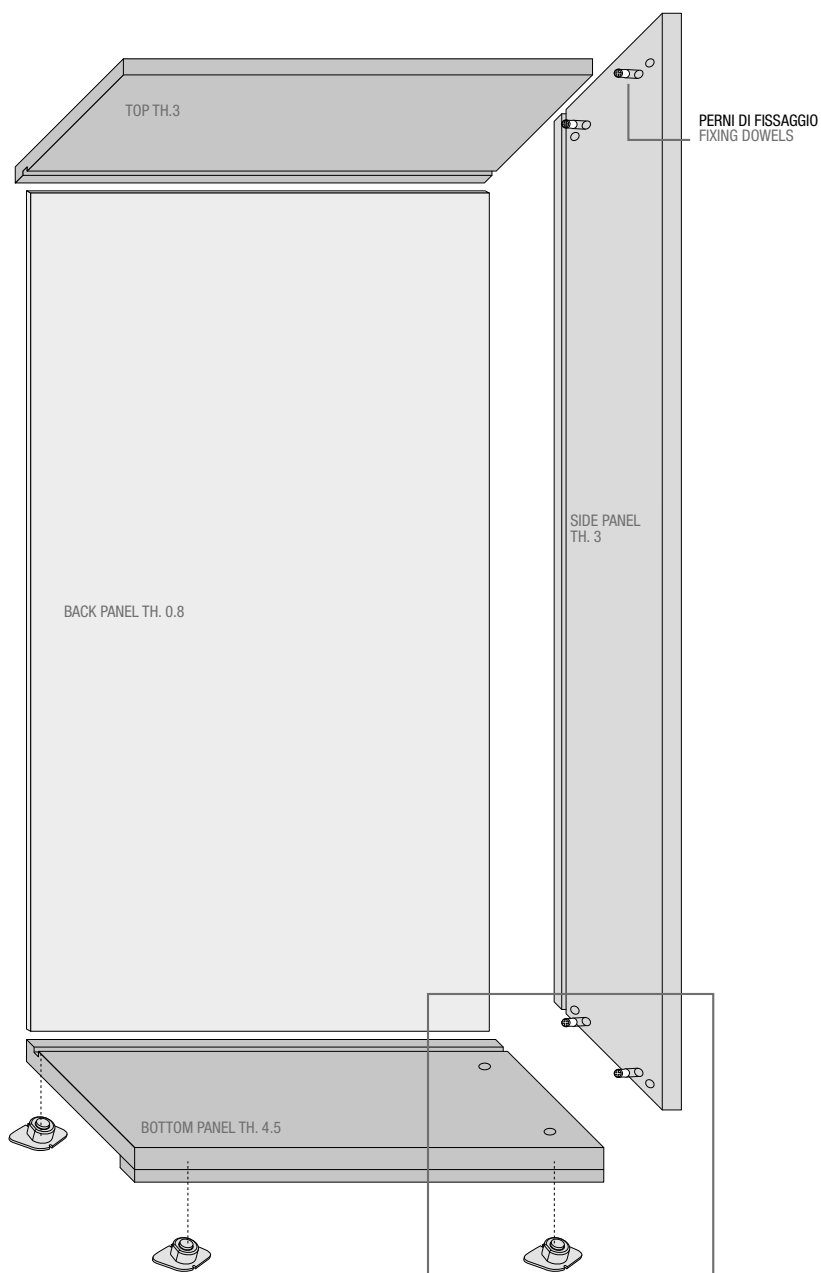

PIEDINO REGOLATORE CON BARILOTTO DI ASSEMBLAGGIO
ADJUSTABLE FOOT WITH ASSEMBLY BOLT

IL PIEDINO REGOLATORE HA DUE FUNZIONI IN UNA:
- LA PRIMA DI FISSAGGIO DEGLI ELEMENTI DELLA PARETE,
- LA SECONDA PER LA MESSA IN BOLLA.
È DOTATO DI ALETTA LATERALE PER IL SOSTEGNO DELLA SPALLA.

THE ADJUSTABLE FOOT HAS A DOUBLE FUNCTION:
- IT FIRST FASTENS THE WALL ELEMENTS
- SECONDLY IT IS USED FOR HEIGHT ADJUSTMENT.
IT IS PROVIDED WITH A SIDE FLAP TO SUPPORT THE END SIDE PANEL.

IL RIPIANO STRUTTURALE È IN LEGNO DA SP. 3. WOODEN STRUCTURAL SHELF TH. 3.

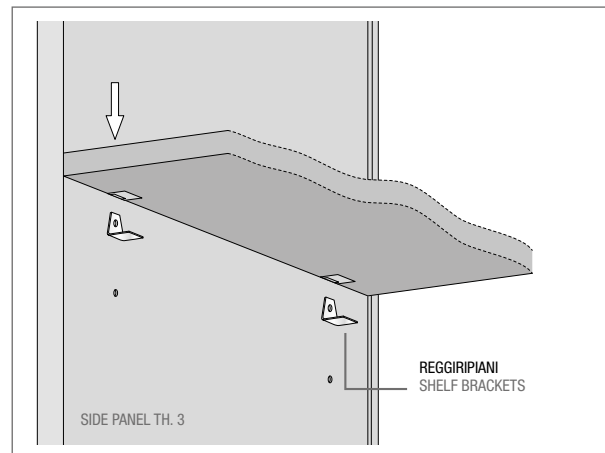

IL RIPIANO PORTAOGGETTI È IN VETRO DA SP. 0.8. GLASS SHELF TH. 0.8.

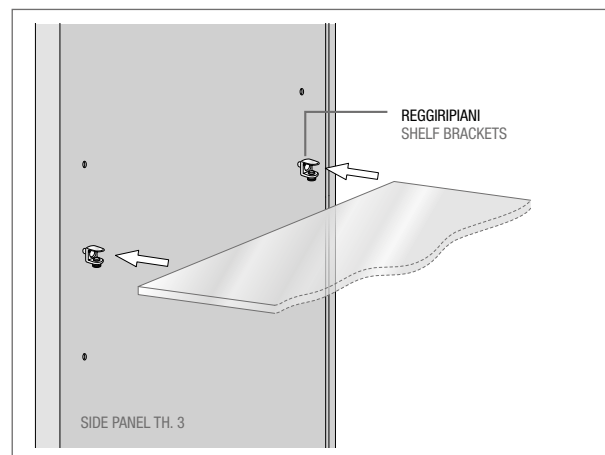

LE FORATURE DEI REGGIPIANI SONO PREDEFINITE IN BASE ALLA DISPOSIZIONE DEI VARI MODULI.
THE HOLES IN THE SHELF SUPPORTS DEPEND ON THE ARRANGEMENT OF THE MODULES.

PIEDINO REGOLATORE CON FUNZIONE DI AGGANCI CON IL PERNO DELLA SPALLA
ADJUSTABLE FOOT WITH ATTACHMENT FUNCTION WITH SUPPORT PANEL DOWEL

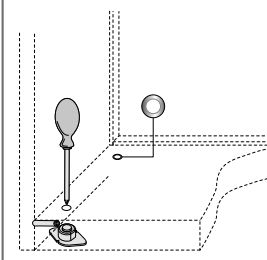

PIEDINO REGOLATORE CON FUNZIONE DI REGOLAZIONE DI LIVELLO
ADJUSTABLE FOOT WITH LEVELLING FUNCTION.

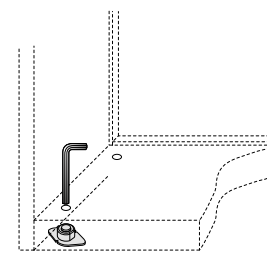

IL FORO SULLA BASE DEL PIEDINO HA UN ANELLO CROMATO DI FINITURA Ø CM. 0.8
HOLE ON BASE UNIT WITH FOOT HAS A FINISH CHROMED RING Ø CM. 0.8

**LO SCHIENALE VA INSERITO IN FRESATA SU BASE, COPERCHIO E FIANCO.
PER IL MONTAGGIO IN NICCHIA DELLA PARETE SONO NECESSARI CM. 3 IN LARGHEZZA E CM. 3 IN ALTEZZA.
THE BACK PANEL MUST BE FITTED INTO THE GROOVE OF THE BASE UNIT WITH PANEL, TOP AND SIDE PANEL.
FOR NICHE ASSEMBLY OF WALL CM. 3 IN WIDTH AND CM. 3 IN HEIGHT ARE NECESSARY.**

CARATTERISTICHE TECNICHE E PARTICOLARITÀ DI UTILIZZO

TECHNICAL CHARACTERISTICS AND PARTICULAR USE

SCHEMA DI UTILIZZO RIPIANI

HOW TO USE SHELVES

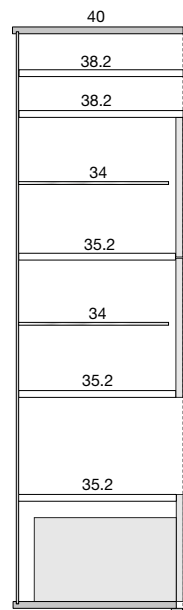

RIPIANI STRUTTURALI A GIORNO
SP. 3 - P. 38.2
OPEN STRUCTURAL SHELVES
TH. 3 - D. 38.2

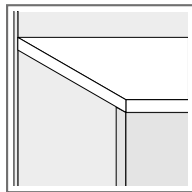

RIPIANI STRUTTURALI INTERNI
SP. 3 - P. 35.2
INTERNAL STRUCTURAL SHELVES
TH. 3 - D. 35.2

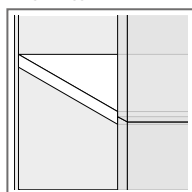

RIPIANI INTERNI PORTAOGGETTI
IN VETRO P. 34 - SP. 0.8
GLASS INTERNAL
SHELVES D. 34 - TH. 0.8

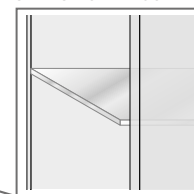

RIPIANI STRUTTURALI INTERNI
SP. 3 - P. 35.2
INTERNAL STRUCTURAL SHELVES
TH. 3 - D. 35.2

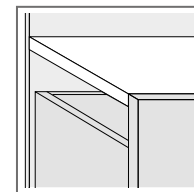

**IL RIPIANO LEGNO P. 38.2/35.2 VIENE UTILIZZATO SOLAMENTE COME RIPIANO STRUTTURALE.
IL RIPIANO VETRO VIENE UTILIZZATO SOLAMENTE COME RIPIANO INTERNO ALL'ANTA.
(È POSSIBILE METTERE IL RIPIANO LEGNO P. 34 - SP. 1.5 AL POSTO DEL VETRO, SOLO COME OPTIONAL)**
THE WOODEN SHELF D. 38.2/35.2 IS USED ONLY AS STRUCTURAL SHELF.
THE GLASS SHELF IS USED ONLY AS DOOR INSIDE SHELF.
(WOODEN SHELF IS POSSIBLE D. 34 - TH. 1.5 INSTEAD THE GLASS SHELF, ONLY AS AN OPTIONAL)

LIMITI DI UTILIZZO PER PENSILI VASISTAS E RIBALTA

USE LIMITS FOR WALL UNITS WITH LIFT-UP DOORS AND DROP-DOWN DOORS

DECOR:
È POSSIBILE SOVRAPPORRE DUE PENSILI VASISTAS O DUE PENSILI RIBALTA SOLO CON MAGGIORAZIONE E CAMBIANDO CERINERE
DECOR:
IT IS POSSIBLE TO STACK TWO WALL UNITS WITH LIFT-UP DOORS OR TWO WALL UNITS WITH DROP-DOWN DOORS ONLY WITH SURCHARGE AND CHANGING HINGES

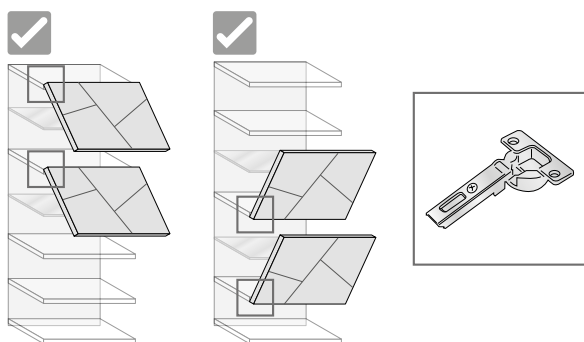

ALTEZZE MASSIME DI POSIZIONAMENTO ANTE VASISTAS/RIBALTA

MAXIMUM POSITION HEIGHTS FOR LIFT-UP/DROP-DOWN DOORS

ANTA VASISTAS
LIFT-UP DOOR

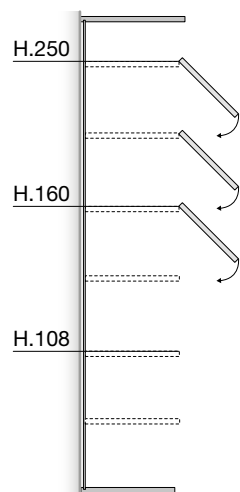

ANTA RIBALTA
DROP-DOWN DOOR

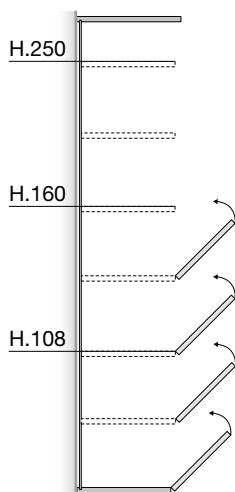

**POSIZIONAMENTO ANTE A RIBALTA DA H. 4.5 A H. 160
POSIZIONAMENTO ANTE A VASISTAS DA H. 160 A H. 250**
POSITION OF DROP-DOWN DOORS H. 4.5 A H. 160
POSITION OF LIFT-UP DOORS FROM H. 160 TO H. 250

DECOR SISTEMA PARETE - WALL SYSTEM

CARATTERISTICHE TECNICHE E PARTICOLARITÀ DI UTILIZZO

TECHNICAL CHARACTERISTICS AND PARTICULAR USE

ALTEZZA E LARGHEZZA CESTONI

BASKETS HEIGHT AND WIDTH

FRONTALE CESTONE

BASKET FRONT

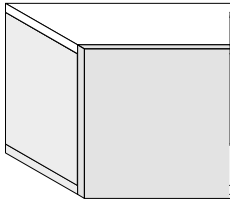

ALTEZZE CESTONI

BASKET HEIGHTS

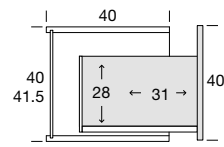

LARGHEZZE CESTONI

BASKET WIDTHS

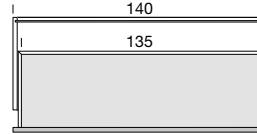
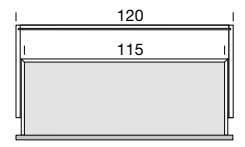
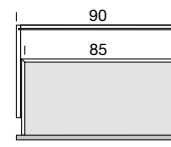
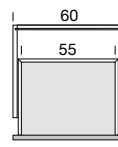

ALTEZZA MASSIMA PER POSIZIONAMENTO CASSETTI E CESTONI: CM.116

MAX HEIGHT FOR DRAWER AND BASKET POSITION: CM.116

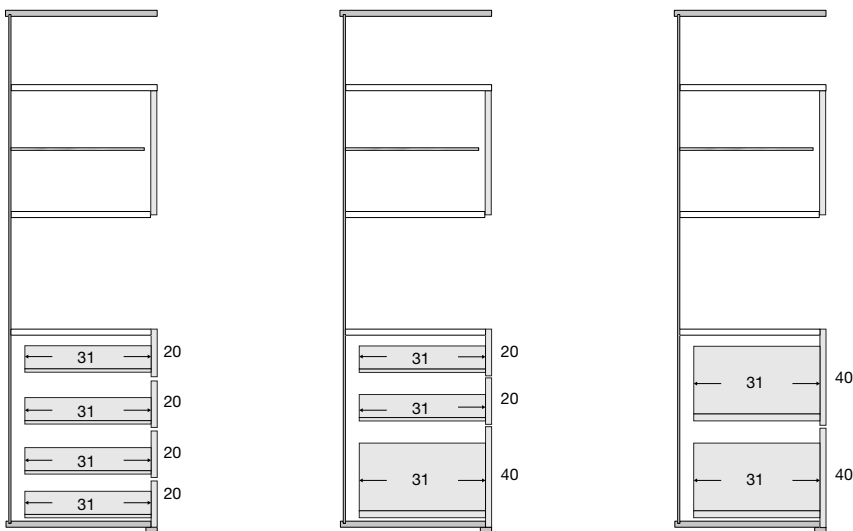

NELLA COLONNA SI POSSONO SOVRAPPORRE AL MASSIMO 4 CASSETTI OPPURE 2 CESTONI.

MAXIMUM HEIGHT FOR DRAWER AND BASKET POSITION: CM.116

ACCESSORI OPTIONAL OPTIONAL ACCESSORIES

**BARRA LED A BASSO CONSUMO
ACCENSIONE TOUCH
IN ALLUMINIO L. 37.2
COLLEGAMENTO
A CARICO DEL CLIENTE**

**LOW CONSUMPTION LED BAR
TOUCH SWITCH
IN ALUMINIUM W. 37.2
CONNECTIONS
TO BE MADE BY THE CUSTOMER.**



codice
code

ZZZFE22001

163

ALIMENTATORE POWER SUPPLY

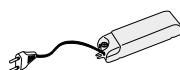

codice
code

ZZZFE22002

67

TELECOMANDO REMOTE CONTROL



codice
code

ZZZFE22004

158

**KIT SPORTELLO PASSACAVI
+ BORCHIA
KIT FOR CABLE MANAGEMENT HOLE
+ COVER**

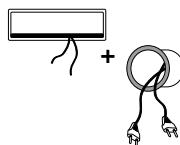

codice
code

ZZZFE22005

133

**MULTIPRESA A SCOMPARSA CON
SPORTELLINO APRI/CHIUDI IN
METALLO**

**CONCEALED MULTIPLE SOCKET
WITH METAL OPEN/CLOSE FLAP**

VERSIONE TV:
1 PRESA SCHUKO
2 PRESI USB RICARICA
1 PRESA SAT.
TV VERSION:
1 SCHUKO SOCKET
2 SOCKETS USB CHARGE
1 SAT. SOCKET



codice
code

ZZZFE22030

595

VERSIONE PC/MAC:
1 PRESA SCHUKO
2 PORTE USB DATI
1 PORTA HDMI
PC/MAC VERSION:
1 SCHUKO SOCKET
2 USB PORT
1 HDMI PORT



codice
code

ZZZFE22031

595

DECOR SISTEMA PARETE - WALL SYSTEM

COMPONENTI STRUTTURALI STRUCTURAL COMPONENTS

FIANCHI A TERRA

P. 40 – SP. 3

FLOOR-STANDING
SIDE PANELS

D. 40 – TH. 3

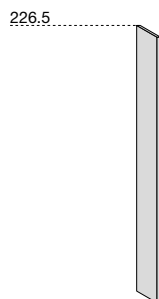

altezza height	codice code	NOCE-FRASSINO WALNUT-ASHWOOD	
226.5	PFP1031C	433	mc 0,04 – Kg 2

DIVISIONI A TERRA

P. 40 – SP. 3

FLOOR-STANDING
PARTITIONS

D. 40 – TH. 3

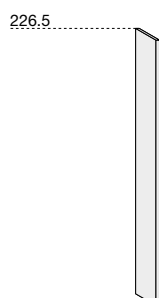

altezza height	codice code	NOCE-FRASSINO WALNUT-ASHWOOD	
226.5	PFP1071C	446	mc 0,04 – Kg 2

DIVISIONI VERTICALI

P. 38.2 – SP. 3

VERTICAL PARTITIONS

D. 38.2 – TH. 3

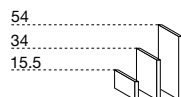

altezza height	codice code	NOCE-FRASSINO WALNUT-ASHWOOD	
15.5	PFP1311C	85	mc 0,01 – Kg 1
34	PFP1301C	127	mc 0,01 – Kg 2
54	PFP1321C	145	mc 0,02 – Kg 3

DIVISIONI IN APPOGGIO HOME THEATRE

P. 40 – SP. 3

RAISED PARTITIONS
HOME THEATRE

D. 40 – TH. 3

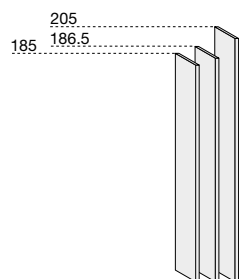

altezza height	codice code	NOCE-FRASSINO WALNUT-ASHWOOD	
185	PFP1251C	397	mc 0,02 – Kg 2
186.5	PFP1261C	397	mc 0,02 – Kg 2
205	PFP1271C	422	mc 0,03 – Kg 2

SCHIENALI A TERRA

226.5 – SP. 0.8

FLOOR-STANDING
BACK PANELS

226.5 – TH. 0.8

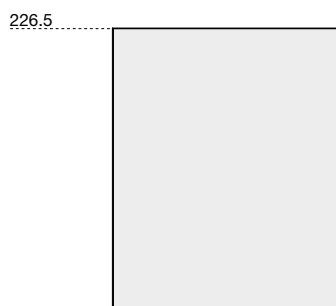

altezza height	larghezza width	codice code	NOCE-FRASSINO WALNUT-ASHWOOD	
226.5	34	PFP7111C	163	mc 0,08 – Kg 1,5
226.5	45	PFP7115C	241	mc 0,10 – Kg 1,5
226.5	60	PFP7231C	259	mc 0,14 – Kg 2
226.5	90	PFP7351C	374	mc 0,20 – Kg 2,5
226.5	120	PFP7711C	470	mc 0,27 – Kg 3,5
226.5	140	PFP8091C	584	mc 0,30 – Kg 4
226.5	180	PFP8071C	668	mc 0,40 – Kg 5

COMPONENTI STRUTTURALI STRUCTURAL COMPONENTS

SCHIENALI IN APPOGGIO

185/186.5/205 – SP. 0.8

RAISED BACK PANELS

185/186.5/205 – TH. 0.8

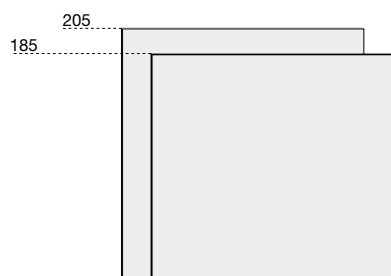

185	60	PFP7171C	229	mc 0,11 – Kg 2
185	90	PFP7301C	301	mc 0,16 – Kg 2,5
185	120	PFP7661C	404	mc 0,22 – Kg 3,5
185	140	PFP7781C	463	mc 0,26 – Kg 4
185	154	PFP7791C	518	mc 0,28 – Kg 4,5
185	180	PFP8021C	572	mc 0,33 – Kg 5
205	60	PFP7191C	247	mc 0,12 – Kg 2
205	90	PFP7331C	338	mc 0,18 – Kg 2,5
205	120	PFP7691C	446	mc 0,24 – Kg 3,5
205	140	PFP7811C	511	mc 0,28 – Kg 4
205	154	PFP7821C	577	mc 0,30 – Kg 4,5
205	180	PFP8051C	625	mc 0,36 – Kg 5

COPERCHI

P. 40 – SP. 3

TOPS

D. 40 – TH. 3

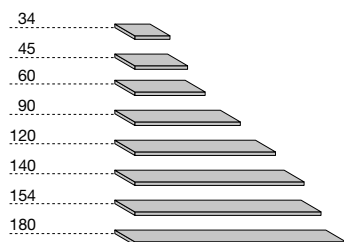

larghezza width	codice code	NOCE-FRASSINO WALNUT-ASHWOOD	
34	PFP3021C	102	mc 0,01 – Kg 0,5
45	PFP3401C	127	mc 0,02 – Kg 1
60	PFP3031C	145	mc 0,02 – Kg 1
90	PFP3041C	193	mc 0,02 – Kg 1,5
120	PFP3071C	235	mc 0,02 – Kg 2,5
140	PFP3081C	289	mc 0,03 – Kg 3
154	PFP3091C	318	mc 0,05 – Kg 3,5
180	PFP3101C	343	mc 0,03 – Kg 4

FONDI CON ZOCCOLO

P. 40 – SP. 4.5

BOTTOM PANELS WITH PLINTH

D. 40 – TH. 4.5

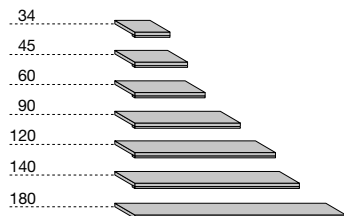

larghezza width	codice code	NOCE-FRASSINO WALNUT-ASHWOOD	
34	PFP2501C	127	mc 0,01 – Kg 0,5
45	PFP2551C	145	mc 0,02 – Kg 1
60	PFP2511C	163	mc 0,02 – Kg 1
90	PFP2521C	198	mc 0,02 – Kg 1,5
120	PFP2531C	247	mc 0,02 – Kg 2,5
140	PFP2561C	301	mc 0,03 – Kg 3
180	PFP2541C	349	mc 0,03 – Kg 4

FONDI INTERNI CON ZOCCOLO

P. 37 – SP. 4.5

INTERNAL BOTTOM PANELS WITH PLINTH

D. 37 – TH. 4.5

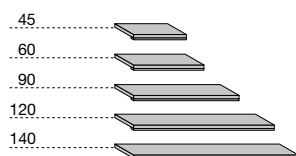

larghezza width	codice code	NOCE-FRASSINO WALNUT-ASHWOOD	
45	PFP2731C	145	mc 0,01 – Kg 0,5
60	PFP2701C	163	mc 0,02 – Kg 1
90	PFP2711C	198	mc 0,02 – Kg 1
120	PFP2721C	247	mc 0,02 – Kg 1,5
140	PFP2741C	301	mc 0,02 – Kg 2,5

DECOR SISTEMA PARETE - WALL SYSTEM

COMPONENTI STRUTTURALI STRUCTURAL COMPONENTS

RIPIANI A GIORNO

P. 38.2 – SP. 3

OPEN SHELVES

D. 38.2 – TH. 3

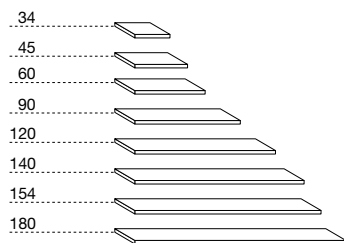

larghezza width	codice code	NOCE-FRASSINO WALNUT-ASHWOOD	
34	PFP2001C	102	mc 0,01 – Kg 0,5
45	PFP2141C	127	mc 0,02 – Kg 1
60	PFP2011C	145	mc 0,02 – Kg 1
90	PFP2021C	193	mc 0,02 – Kg 1,5
120	PFP2051C	235	mc 0,02 – Kg 2,5
140	PFP2061C	289	mc 0,03 – Kg 3
154	PFP2071C	318	mc 0,03 – Kg 3,5
180	PFP2081C	343	mc 0,03 – Kg 4

RIPIANI INTERNI

P. 35.2 – SP. 3

INTERNAL SHELVES

D. 35.2 – TH. 3

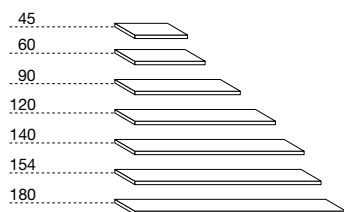

larghezza width	codice code	NOCE-FRASSINO WALNUT-ASHWOOD	
45	PFP2151C	127	mc 0,01 – Kg 0,5
60	PFP2101C	145	mc 0,02 – Kg 1
90	PFP2111C	193	mc 0,02 – Kg 1
120	PFP2121C	235	mc 0,02 – Kg 1,5
140	PFP2131C	289	mc 0,02 – Kg 2,5
154	PFP2171C	318	mc 0,03 – Kg 3
180	PFP2161C	343	mc 0,03 – Kg 4

RIPIANI INTERNI PORTAOGGETTI

P. 34 – SP. 1.5

INTERNAL SHELVES

D. 34 – TH. 1.5



larghezza width	codice code	NOCE-FRASSINO WALNUT-ASHWOOD	
45	PFP2221C	97	mc 0,01 – Kg 0,5
60	PFP2231C	120	mc 0,01 – Kg 1
90	PFP2241C	163	mc 0,01 – Kg 1
120	PFP2251C	187	mc 0,01 – Kg 1,5

RIPIANI INTERNI IN VETRO

P. 34 – SP. 0.8

INTERNAL GLASS SHELVES

D. 34 – TH. 0.8



larghezza width	codice code	NOCE-FRASSINO WALNUT-ASHWOOD	
45	PFP2204C	43	mc 0,01 – Kg 0,5
60	PFP2201C	49	mc 0,01 – Kg 1
90	PFP2202C	61	mc 0,01 – Kg 1
120	PFP2203C	72	mc 0,01 – Kg 1,5

COMPONENTI STRUTTURALI STRUCTURAL COMPONENTS

PANNELLI PORTA TV

H. 95.5/126.5/145 – SP .1.5

TV PANELS

H. 95.5/126.5/145 – TH.1.5

* NECESSARIO PER APPENDERE LA TV ALLO SCHIENALE
NEEDED TO HANG THE TV ON THE BACKREST

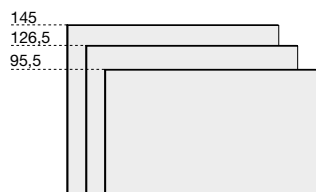

altezza height	larghezza width	codice code	NOCE-FRASSINO WALNUT-ASHWOOD	
95.5	120	PFP6641K	366	mc 0,03 – Kg 3,5
95.5	140	PFP6651K	415	mc 0,03 – Kg 4
95.5	154	PFP6661K	457	mc 0,03 – Kg 4,5
95.5	180	PFP6671K	500	mc 0,04 – Kg 5
126.5	120	PFP6781K	422	mc 0,03 – Kg 3,5
126.5	140	PFP6791K	500	mc 0,04 – Kg 4
126.5	154	PFP6801K	584	mc 0,04 – Kg 4,5
126.5	180	PFP6811K	602	mc 0,04 – Kg 5
145	120	PFP6851K	457	mc 0,04 – Kg 3,5
145	140	PFP6861K	542	mc 0,04 – Kg 4
145	154	PFP6871K	590	mc 0,04 – Kg 4,5
145	180	PFP6881K	638	mc 0,05 – Kg 5

CORNICI PERIMETRALI

H. 228

PER PARETI A TERRA H. 226.5

PERIMETRIC FRAMES

H. 228

FOR FLOOR-STANDING WALLS

H. 226.5

* PARTE SUPERIORE IN 2 PEZZI
TOP PART IN 2 PIECES

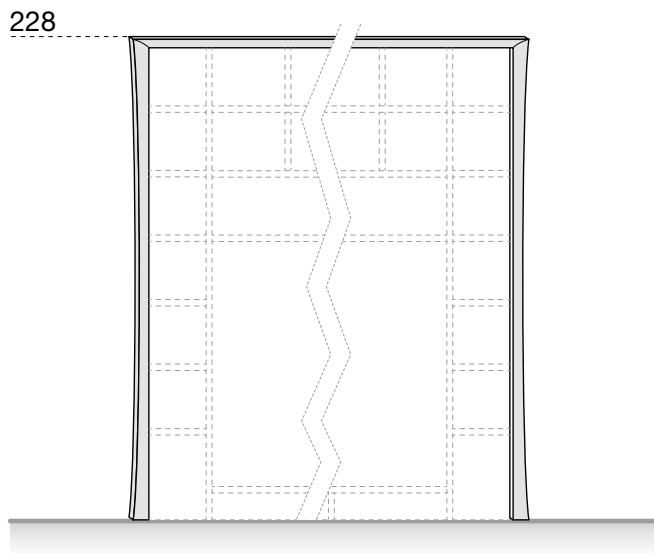

altezza height	larghezza width	codice code	NOCE-FRASSINO WALNUT-ASHWOOD	
228	max 105	PFP9151K	259	mc 0,05 – Kg 2,5
228	106÷225	PFP9161K	283	mc 0,05 – Kg 3
228	226÷355	PFP9171K	331	mc 0,05 – Kg 3,5
* 228	356÷455	PFP9181K	366	mc 0,05 – Kg 4
* 228	456÷555	PFP9191K	391	mc 0,05 – Kg 4,5

INGOMBRI CORNICE PERIMETRALE

DIMENSIONS FOR PERIMETRIC FRAME

VISTA IN PIANTA
LAYOUT VIEW

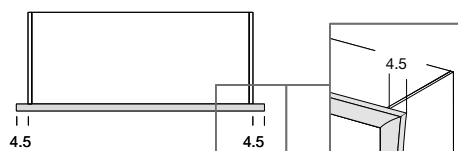

VISTA LATERALE
SIDE VIEW

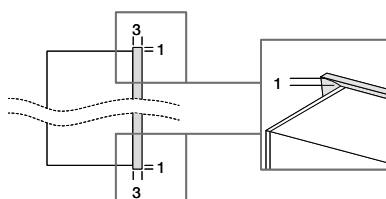

DECOR SISTEMA PARETE - WALL SYSTEM

COMPONENTI STRUTTURALI STRUCTURAL COMPONENTS

ANTE LEGNO DECOR DECOR WOODEN DOORS

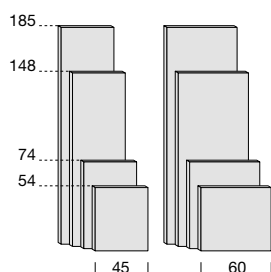

altezza height	larghezza width	codice dx code rh	codice sx code lh	NOCE-FRASSINO WALNUT-ASHWOOD	
54	45	DCP5491C	DCP5492C	247	mc 0,02 – Kg 4
54	60	DCP5431C	DCP5432C	259	mc 0,02 – Kg 5
74	45	DCP5591C	DCP5592C	283	mc 0,02 – Kg 5
74	60	DCP5531C	DCP5532C	289	mc 0,02 – Kg 7
148	45	DCP5521C	DCP5522C	422	mc 0,03 – Kg 10
148	60	DCP5441C	DCP5442C	452	mc 0,03 – Kg 14
185	45	DCP5541C	DCP5542C	494	mc 0,03 – Kg 13
185	60	DCP5461C	DCP5462C	524	mc 0,04 – Kg 17

ANTE VETRO DECOR DECOR GLASS DOORS

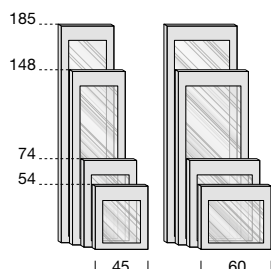

altezza height	larghezza width	codice dx code rh	codice sx code lh	NOCE-FRASSINO WALNUT-ASHWOOD	
54	45	DCP5471C	DCP5472C	247	mc 0,02 – Kg 4
54	60	DCP5561C	DCP5562C	259	mc 0,02 – Kg 5
74	45	DCP5551C	DCP5552C	283	mc 0,02 – Kg 5
74	60	DCP5581C	DCP5582C	289	mc 0,02 – Kg 7
148	45	DCP5631C	DCP5632C	422	mc 0,03 – Kg 10
148	60	DCP5601C	DCP5602C	452	mc 0,03 – Kg 14
185	45	DCP5641C	DCP5642C	494	mc 0,03 – Kg 13
185	60	DCP5621C	DCP5622C	524	mc 0,04 – Kg 17

ANTE DECORATE DECOR DECOR DECORATED DOORS

SPECIFICARE CON O SENZA DECORO FOGLIA
(IL PREZZO È LO STESSO)

PLEASE SPECIFY WITH OR WITHOUT LEAF
DECORATION (THE PRICE IS THE SAME)

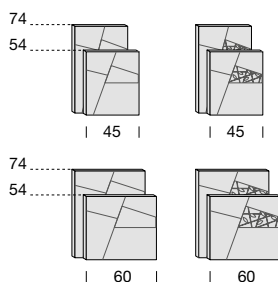

altezza height	larghezza width	codice dx code rh	codice sx code lh	NOCE-FRASSINO WALNUT-ASHWOOD	
54	45	DCP5481C	DCP5482C	386	mc 0,02 – Kg 4
54	60	DCP5401C	DCP5402C	409	mc 0,02 – Kg 5
74	45	DCP5501C	DCP5502C	422	mc 0,02 – Kg 5
74	60	DCP5421C	DCP5422C	457	mc 0,02 – Kg 7

ANTE LEGNO RIBALTA E VASISTAS DECOR H. 37 DECOR LIFT-UP AND WOODEN DROP-DOWN DOORS H. 37

PER LIMITI DI UTILIZZO DELLE ANTE
VASISTAS E RIBALTA CONSULTARE PAG. 294
FOR USE LIMITS OF LIFT-UP AND DROP-
DOWN DOORS SEE PAGE 294

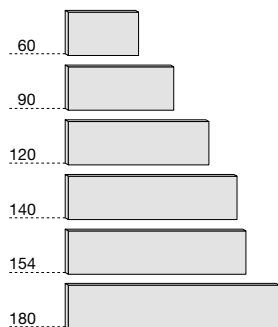

larghezza width	codice vasistas lift-up code	codice ribalta drop-down code	NOCE-FRASSINO WALNUT-ASHWOOD	
60	DCP5341C	DCP5141C	283	mc 0,02 – Kg 4
90	DCP5351C	DCP5041C	313	mc 0,02 – Kg 5
120	DCP5361C	DCP5261C	361	mc 0,02 – Kg 7
140	DCP5271C	DCP5281C	409	mc 0,02 – Kg 8
154	DCP5761C	DCP5791C	422	mc 0,03 – Kg 9
180	DCP5291C	DCP5051C	470	mc 0,03 – Kg 10

ANTE VETRO VASISTAS E RIBALTA DECOR H. 37 DECOR LIFT-UP AND DROP- DOWN GLASS DOORS H. 37

PER LIMITI DI UTILIZZO DELLE ANTE
VASISTAS E RIBALTA CONSULTARE PAG. 294
FOR USE LIMITS OF LIFT-UP AND DROP-
DOWN DOORS SEE PAGE 294

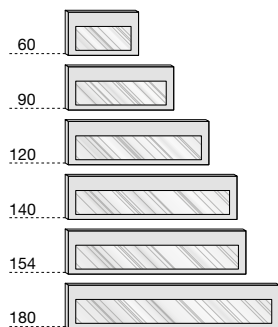

larghezza width	codice vasistas lift-up code	codice ribalta drop-down code	NOCE-FRASSINO WALNUT-ASHWOOD	
60	DCP5301C	DCP5101C	283	mc 0,02 – Kg 4
90	DCP5311C	DCP5111C	313	mc 0,02 – Kg 5
120	DCP5321C	DCP5121C	361	mc 0,02 – Kg 7
140	DCP5411C	DCP5451C	409	mc 0,02 – Kg 8
154	DCP5771C	DCP5801C	422	mc 0,03 – Kg 9
180	DCP5331C	DCP5131C	470	mc 0,03 – Kg 10

FRONTALI DECOR DECOR FRONTS

ANTE DECORATE VASISTAS E RIBALTA DECOR H. 37 DECOR DECORATED LIFT-UP AND DROP-DOWN DOORS H. 37

PER LIMITI DI UTILIZZO DELLE ANTE
VASISTAS E RIBALTA CONSULTARE PAG. 295
FOR USE LIMITS OF LIFT-UP AND DROP-
DOWN DOORS SEE PAGE 295

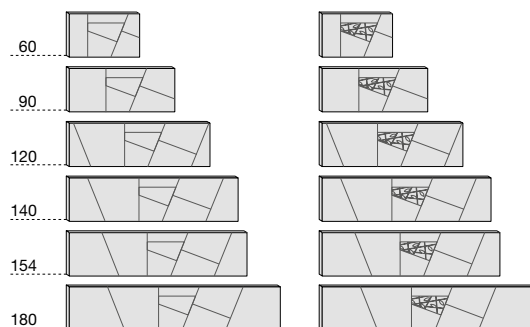

larghezza width	codice vasistas lift-up code	codice ribalta drop-down code	NOCE-FRASSINO WALNUT-ASHWOOD	
60	DCP5201C	DCP5001C	559	mc 0,02 – Kg 4
90	DCP5211C	DCP5011C	620	mc 0,02 – Kg 5
120	DCP5221C	DCP5021C	686	mc 0,02 – Kg 7
140	DCP5241C	DCP5251C	740	mc 0,02 – Kg 8
154	DCP5781C	DCP5811C	794	mc 0,03 – Kg 9
180	DCP5231C	DCP5031C	938	mc 0,03 – Kg 10

CASSETTI H. 20 DECOR DRAWERS H. 20 DECOR

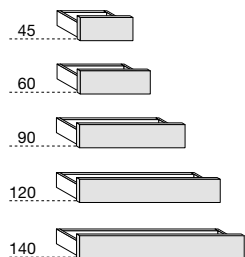

larghezza width	codice code	NOCE-FRASSINO WALNUT-ASHWOOD	
45	DCP4031C	308	mc 0,05 – Kg 4,5
60	DCP4001C	308	mc 0,06 – Kg 6
90	DCP4011C	349	mc 0,08 – Kg 9
120	DCP4021C	404	mc 0,12 – Kg 12
140	DCP4041C	446	mc 0,14 – Kg 14

CESTONI H. 40 DECOR BASKETS H. 40 DECOR

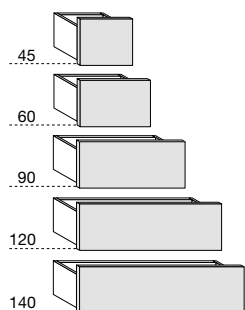

larghezza width	codice code	NOCE-FRASSINO WALNUT-ASHWOOD	
45	DCP4261C	457	mc 0,08 – Kg 9
60	DCP4231C	470	mc 0,12 – Kg 12
90	DCP4241C	511	mc 0,17 – Kg 18
120	DCP4251C	567	mc 0,23 – Kg 24
140	DCP4281C	674	mc 0,27 – Kg 28

CESTONI FRONTALE DECORATO H. 40 DECOR BASKETS WITH DECORATED FRONT H. 40 DECOR

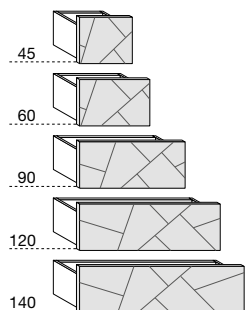

larghezza width	codice code	NOCE-FRASSINO WALNUT-ASHWOOD	
45	DCP4271C	577	mc 0,08 – Kg 9
60	DCP4201C	590	mc 0,12 – Kg 12
90	DCP4211C	632	mc 0,17 – Kg 18
120	DCP4221C	716	mc 0,23 – Kg 24
140	DCP4291C	842	mc 0,27 – Kg 28

DECOR SISTEMA PARETE - WALL SYSTEM

MODULI A COLONNA H. 226.5 – P. 40

TALL UNIT MODULES H. 226.5 – D. 40

MODULI A GIORNO OPEN MODULES

5 RIPIANI
5 SHELVES

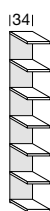

PFP5001M

5 RIPIANI
5 SHELVES

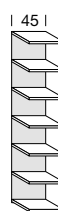

PFP5005M

5 RIPIANI
5 SHELVES



PFP5011M

NOCE-FRASSINO / WALNUT-ASHWOOD

861

1.070

1.221

5 RIPIANI
5 SHELVES

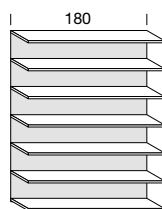

PFP5851M

3 RIPIANI
3 SHELVES

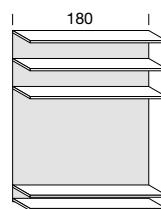

PFP5861M

5 RIPIANI ANGOLO
5 CORNER SHELVES

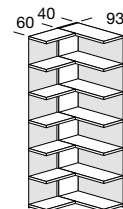

PFP6131M

NOCE-FRASSINO / WALNUT-ASHWOOD

2.360

2.345

3.289

MODULI L. 45 MODULES W. 45

1 ANTA LEGNO
1 WOODEN DOOR

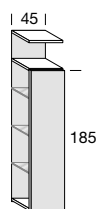

DCP5115M

1 ANTA VETRO
1 GLASS DOOR

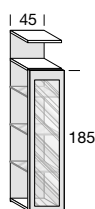

DCP5125M

1 ANTA LEGNO, 1 RIPIANO
1 WOODEN DOOR, 1 SHELF

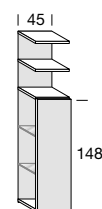

DCP5135M

NOCE-FRASSINO / WALNUT-ASHWOOD

1.191

1.191

1.203

1 ANTA LEGNO, 1 RIPIANO,
1 ANTA VETRO
1 WOODEN DOOR, 1 SHELF,
1 GLASS DOOR

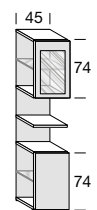

DCP5335M

1 ANTA LEGNO, 1 RIPIANO,
1 ANTA DECORATA/TRAFORATA
1 WOODEN DOOR, 1 SHELF,
1 DECORATED/PERFORATED DOOR

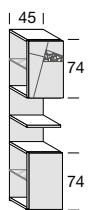

DCP5345M

2 CASSETTI, 1 ANTA VETRO, 1 ANTA DECORATA/
TRAFORATA
2 DRAWERS, 1 GLASS DOOR, 1 DECORATED/
PERFORATED DOOR

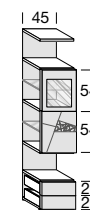

DCP5355M

NOCE-FRASSINO / WALNUT-ASHWOOD

1.456

1.593

2.242

N.B.: INDICARE SEMPRE IL VERSO DELL'ANTA (DX O SX)
N.B.: ALWAYS INDICATE THE DIRECTION OF DOOR (RH OR LH)

5 RIPIANI
5 SHELVES

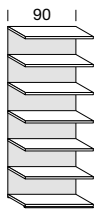

PFP5371M

1.684

5 RIPIANI
5 SHELVES

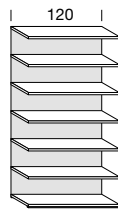

PFP5611M

2.062

5 RIPIANI
5 SHELVES

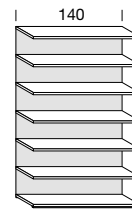

PFP6001M

2.579

EL. STRUTTURALI E OPTIONAL OPTIONAL AND STRUCTURAL EL.

FIANCO A TERRA SP. 3
FLOOR-STANDING SIDE PANEL TH. 3



PFP1031C

433

mc 0,04 - Kg 2

DIVISIONE A TERRA SP. 3
FLOOR-STANDING PARTITION TH. 3



PFP1071C

446

mc 0,04 - Kg 2

BARRA LED A BASSO CONSUMO
ACCENSIONE TOUCH
IN ALLUMINIO L. 37.2
LOW CONSUMPTION LED BAR
TOUCH SWITCH
IN ALUMINIUM W. 37.2



ZZZFE22001

163

ALIMENTATORE
POWER SUPPLY



ZZZFE22002

67

COLLEGAMENTO
A CARICO DEL CLIENTE
CONNECTIONS
TO BE MADE BY THE CUSTOMER.

1 ANTA VETRO, 1 RIPIANO
1 GLASS DOOR, 1 SHELF

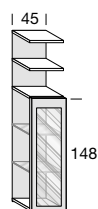

DCP5145M

1.203

2 ANTE LEGNO, 1 RIPIANO
2 WOODEN DOORS, 1 SHELF

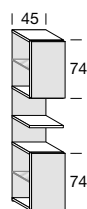

DCP5155M

1.456

2 ANTE DECORATE/TRAFORATE, 1 RIPIANO
2 DECORATED/PERFORATED DOORS, 1 SHELF

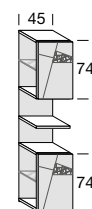

DCP5325M

1.737

2 CASSETTI, 2 ANTE VETRO
2 DRAWERS, 2 GLASS DOORS

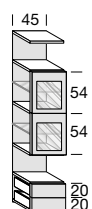

DCP5365M

2.098

2 CASSETTI, 2 ANTE DECORATE
2 DRAWERS, 2 DECORATED DOORS

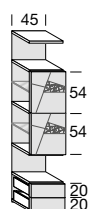

DCP5165M

2.381

*
SPECIFICARE CON O SENZA DECORO
FOGLIA
(IL PREZZO È LO STESSO)
PLEASE SPECIFY WITH OR WITHOUT
LEAF DECORATION
(THE PRICE IS THE SAME)

POSSIBILITÀ DI FRONTALE DIVERSO
DALLA SCOCCA, SPECIFICARE LA
FINITURA SCELTA

IN CASE OF FRONT DIFERENT FROM
THE CARCASE CONSIDER THE
HIGHER PRICE OF THE CHOOSEN
FINISH

DECOR SISTEMA PARETE - WALL SYSTEM

MODULI A COLONNA H. 226.5 – P. 40

TALL UNIT MODULES H. 226.5 – D. 40

MODULI L. 45 MODULES W. 45

1 CESTONE, 1 ANTA VETRO,
1 ANTA LEGNO
1 BASKET, 1 GLASS DOOR,
1 WOODEN DOOR

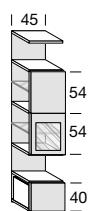

DCP5175M

1 CESTONE, 1 ANTA DECORATA,
1 ANTA LEGNO
1 BASKET, 1 DECORATED DOOR,
1 WOODEN DOOR

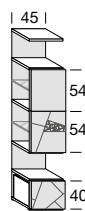

DCP5185M

*

NOCE-FRASSINO / WALNUT-ASHWOOD

1.948

2.207

MODULI L. 60 MODULES W. 60

1 ANTA LEGNO
1 WOODEN DOOR

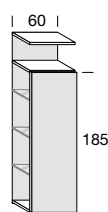

DCP5211M

1 ANTA VETRO
1 GLASS DOOR

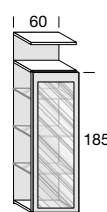

DCP5231M

1 ANTA LEGNO, 1 RIPIANO
1 WOODEN DOOR, 1 SHELF

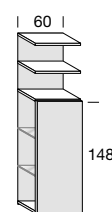

DCP5171M

NOCE-FRASSINO / WALNUT-ASHWOOD

1.323

1.323

1.341

1 CESTONE, 1 ANTA VETRO
1 BASKET, 1 GLASS DOOR

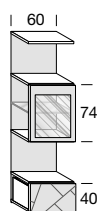

DCP5151M

1 CESTONE, 1 ANTA DECORATA/TRAFORATA
1 BASKET, 1 DECORATED/PERFORATED DOOR

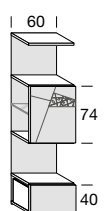

DCP5132M

*

1 CESTONE, 1 ANTA DECORATA
1 BASKET, 1 DECORATED DOOR

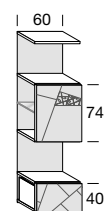

DCP5131M

*

NOCE-FRASSINO / WALNUT-ASHWOOD

1.858

1.900

2.032

2 CASSETTI, 1 ANTA DECORATA/TRAFORATA,
1 ANTA LEGNO
2 DRAWERS, 1 DECORATED/PERFORATED DOOR,
1 WOODEN DOOR

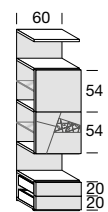

DCP5273M

2 CASSETTI, 1 ANTA DECORATA/TRAFORATA,
1 ANTA VETRO
2 DRAWERS, 1 DECORATED/PERFORATED DOOR,
1 GLASS DOOR

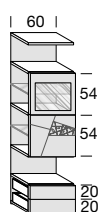

DCP5263M

*

1 CESTONE, 2 ANTE VETRO
1 BASKET, 2 GLASS DOORS

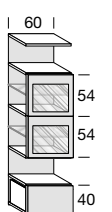

DCP5241M

NOCE-FRASSINO / WALNUT-ASHWOOD

2.435

2.435

2.134

N.B.: INDICARE SEMPRE IL VERSO DELL'ANTA (DX O SX)
N.B.: ALWAYS INDICATE THE DIRECTION OF DOOR (RH OR LH)

1 CESTONE, 1 ANTA DECORATA,
1 ANTA VETRO
1 BASKET, 1 DECORATED DOOR,
1 GLASS DOOR

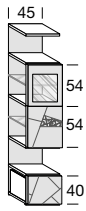

*

DCP5195M

2.207

3 ANTE LEGNO
3 WOODEN DOORS

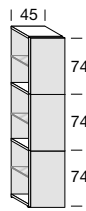

DCP5205M

1.648

2 ANTE LEGNO, 1 ANTA VETRO
2 WOODEN DOORS, 1 GLASS DOOR

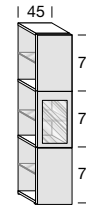

DCP5315M

1.648

1 ANTA VETRO, 1 RIPIANO
1 GLASS DOOR, 1 SHELF

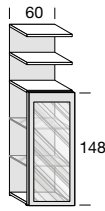

DCP5191M

1.341

1 CESTONE, 3 RIPIANI
1 BASKET, 3 SHELVES

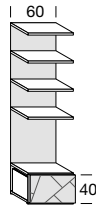

DCP5041M

1.672

2 ANTE DECORATE/TRAFORATE, 1 RIPIANO
2 DECORATED/PERFORATED DOORS, 1 SHELF

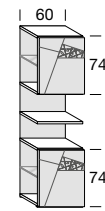

*

DCP5291M

1.930

2 CASSETTI, 2 ANTE VETRO
2 DRAWERS, 2 GLASS DOORS

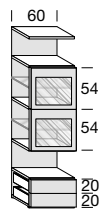

DCP5271M

2.285

2 CASSETTI, 2 ANTE DECORATE/TRAFORATE
2 DRAWERS, 2 DECORATED/PERFORATED DOORS

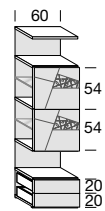

*

DCP5251M

2.597

1 CESTONE, 2 ANTE DECORATE/TRAFORATE
1 BASKET, 2 DECORATED/PERFORATED DOORS

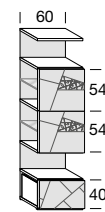

*

DCP5261M

2.562

1 CESTONE, 1 ANTA VETRO,
1 ANTA LEGNO
1 BASKET, 1 GLASS DOOR,
1 WOODEN DOOR

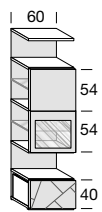

DCP5242M

2.255

1 CESTONE, 1 ANTA DECORATA,
1 ANTA VETRO
1 BASKET, 1 DECORATED DOOR,
1 GLASS DOOR

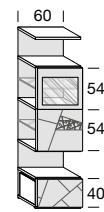

*

DCP5021M

2.405

EL. STRUTTURALI E OPTIONAL OPTIONAL AND STRUCTURAL EL.

FIANCO A TERRA SP. 3
FLOOR-STANDING SIDE PANEL TH. 3



PFP1031C

433

mc 0,04 – Kg 2

DIVISIONE A TERRA SP. 3
FLOOR-STANDING PARTITION TH. 3



PFP1071C

446

mc 0,04 – Kg 2

BARRA LED A BASSO CONSUMO
ACCENSIONE TOUCH
IN ALLUMINIO L. 37.2
LOW CONSUMPTION LED BAR
TOUCH SWITCH
IN ALUMINIUM W. 37.2



ZZZFE22001

163

ALIMENTATORE
POWER SUPPLY



ZZZFE22002

67

COLLEGAMENTO
A CARICO DEL CLIENTE
CONNECTIONS
TO BE MADE BY THE CUSTOMER.

*
SPECIFICARE CON O SENZA DECORO
FOGLIA
(IL PREZZO È LO STESSO)
PLEASE SPECIFY WITH OR WITHOUT
LEAF DECORATION
(THE PRICE IS THE SAME)

POSSIBILITÀ DI FRONTALE DIVERSO
DALLA SCOCCA, SPECIFICARE LA
FINITURA SCELTA

IN CASE OF FRONT DIFERENT FROM
THE CARCASE CONSIDER THE
HIGHER PRICE OF THE CHOOSEN
FINISH

DECOR SISTEMA PARETE - WALL SYSTEM

MODULI A COLONNA H. 226.5 – P. 40

TALL UNIT MODULES H. 226.5 – D. 40

MODULI L. 60
MODULES W. 60

1 CESTONE, 1 ANTA DECORATA/TRAFORATA,
1 ANTA LEGNO
1 BASKET, 1 DECORATED/PERFORATED DOOR,
1 WOODEN DOOR

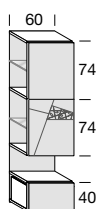

*

DCP5302M

1 CESTONE, 1 ANTA DECORATA,
1 ANTA LEGNO
1 BASKET, 1 DECORATED DOOR,
1 WOODEN DOOR

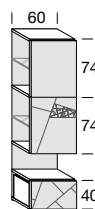

*

DCP5341M

1 CESTONE, 1 ANTA DECORATA,
1 ANTA VETRO
1 BASKET, 1 DECORATED DOOR,
1 GLASS DOOR

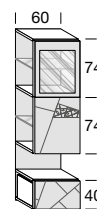

*

DCP5301M

NOCE-FRASSINO / WALNUT-ASHWOOD

2.225

2.351

2.351

MODULI L. 90
MODULES W. 90

2 ANTE LEGNO
2 WOODEN DOORS

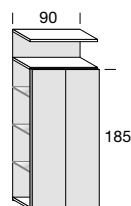

DCP3702M

2 ANTE VETRO
2 GLASS DOORS

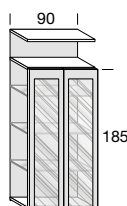

DCP3711M

1 CESTONE, 3 RIPIANI
1 BASKET, 3 SHELVES

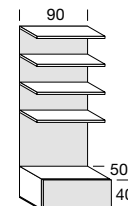

DCP3722M

NOCE-FRASSINO / WALNUT-ASHWOOD

1.973

1.973

2.009

2 CASSETTI, 1 RIPIANO,
1 VASISTAS DECORATA
2 DRAWERS, 1 SHELF,
1 DECORATED LIFT-UP DOOR

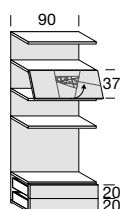

*

DCP5381M

1 CESTONE, 1 RIPIANO,
1 VASISTAS LEGNO
1 BASKET, 1 SHELF,
1 WOODEN LIFT-UP DOOR

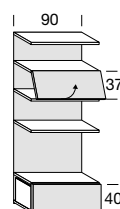

DCP5382M

1 CESTONE, 1 RIPIANO,
1 VASISTAS LEGNO
1 BASKET, 1 SHELF,
1 WOODEN LIFT-UP DOOR

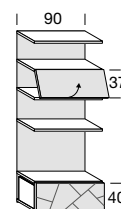

DCP5391M

NOCE-FRASSINO / WALNUT-ASHWOOD

2.802

2.314

2.435

1 CESTONE, 1 RIPIANO
1 VASISTAS DECORATA
1 BASKET, 1 SHELF,
1 DECORATED LIFT-UP DOOR

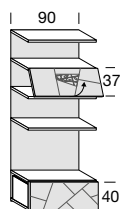

*

DCP3751M

2 ANTE LEGNO, 4 ANTE VETRO
2 WOODEN DOORS, 4 GLASS DOORS

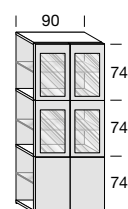

DCP5461M

2 CASSETTI, 4 ANTE LEGNO
2 DRAWERS, 4 WOODEN DOORS

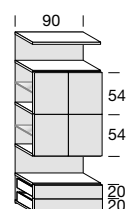

DCP5491M

NOCE-FRASSINO / WALNUT-ASHWOOD

2.747

2.940

3.240

N.B.: INDICARE SEMPRE IL VERSO DELL'ANTA (DX O SX)
N.B.: ALWAYS INDICATE THE DIRECTION OF DOOR (RH OR LH)

3 ANTE LEGNO
3 WOODEN DOORS

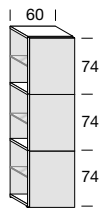

DCP5332M

1.780

3 ANTE DECORATE/TRAFORATE
3 DECORATED/PERFORATED DOORS

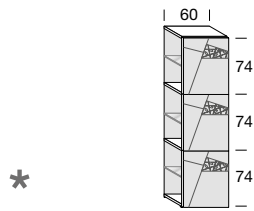

DCP5331M

2.285

2 ANTE LEGNO, 1 ANTA VETRO
2 WOODEN DOORS, 1 GLASS DOOR

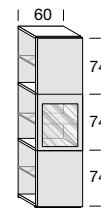

DCP5354M

1.780

1 CESTONE, 3 RIPIANI
1 BASKET, 3 SHELVES

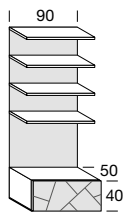

DCP3721M

2.134

2 CASSETTI, 1 RIPIANO,
1 VASISTAS LEGNO
2 DRAWERS, 1 SHELF,
1 WOODEN LIFT-UP DOOR

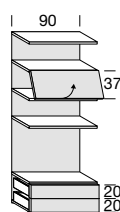

DCP3731M

2.489

2 CASSETTI, 1 RIPIANO,
1 VASISTAS VETRO
2 DRAWERS, 1 SHELF,
1 GLASS LIFT-UP DOOR

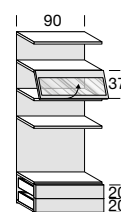

DCP5371M

2.489

1 CESTONE, 1 RIPIANO,
1 VASISTAS VETRO
1 BASKET, 1 SHELF,
1 GLASS LIFT-UP DOOR

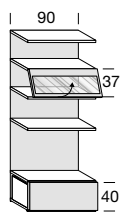

DCP5392M

2.314

1 CESTONE, 1 RIPIANO,
1 VASISTAS VETRO
1 BASKET, 1 SHELF,
1 GLASS LIFT-UP DOOR

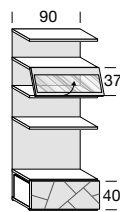

DCP3741M

2.453

1 CESTONE, 1 RIPIANO,
1 VASISTAS DECORATA
1 BASKET, 1 SHELF,
1 DECORATED LIFT-UP DOOR

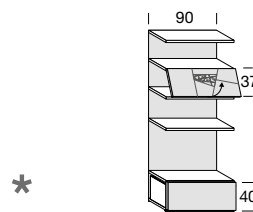

DCP3752M

2.627

2 CASSETTI, 4 ANTE VETRO
2 DRAWERS, 4 GLASS DOORS

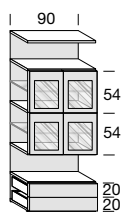

DCP5551M

3.240

1 CESTONE, 4 ANTE DECORATE
1 BASKET, 4 DECORATED DOORS

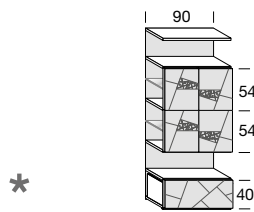

DCP5561M

3.751

1 CESTONE, 2 ANTE LEGNO,
2 ANTE VETRO
1 BASKET, 2 WOODEN DOORS,
2 GLASS DOORS

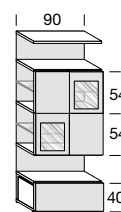

DCP5571M

3.060

EL. STRUTTURALI E OPTIONAL OPTIONAL AND STRUCTURAL EL.

FIANCO A TERRA SP. 3
FLOOR-STANDING SIDE PANEL TH. 3



PFP1031C

433

mc 0,04 – Kg 2

DIVISIONE A TERRA SP. 3
FLOOR-STANDING PARTITION TH. 3



PFP1071C

446

mc 0,04 – Kg 2

BARRA LED A BASSO CONSUMO
ACCENSIONE TOUCH
IN ALLUMINIO L. 37.2
LOW CONSUMPTION LED BAR
TOUCH SWITCH
IN ALUMINIUM W. 37.2



ZZZFE22001

163

ALIMENTATORE
POWER SUPPLY



ZZZFE22002

67

COLLEGAMENTO
A CARICO DEL CLIENTE
CONNECTIONS
TO BE MADE BY THE CUSTOMER.

*** SPECIFICARE CON O SENZA DECORO**
FOGLIA
(IL PREZZO È LO STESSO)
PLEASE SPECIFY WITH OR WITHOUT
LEAF DECORATION
(THE PRICE IS THE SAME)

POSSIBILITÀ DI FRONTALE DIVERSO
DALLA SCOCCA, SPECIFICARE LA
FINITURA SCELTA

IN CASE OF FRONT DIFERENT FROM
THE CARCASE CONSIDER THE
HIGHER PRICE OF THE CHOOSEN
FINISH

DECOR SISTEMA PARETE - WALL SYSTEM

MODULI A COLONNA H. 226.5 – P. 40

TALL UNIT MODULES H. 226.5 – D. 40

MODULI L. 90
MODULES W. 90

1 CESTONE, 2 ANTE LEGNO,
2 ANTE DECORATE
1 BASKET, 2 WOODEN DOORS,
2 DECORATED DOORS

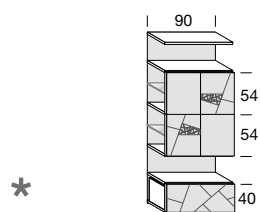

DCP5581M

NOCE-FRASSINO / WALNUT-ASHWOOD

3.468

1 CESTONE, 2 ANTE VETRO,
2 ANTE DECORATE
1 BASKET, 2 GLASS DOORS,
2 DECORATED DOORS

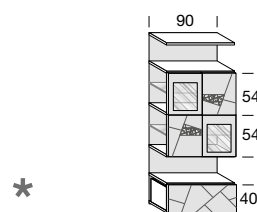

DCP5591M

3.468

2 ANTE LEGNO, 1 RIBALTA LEGNO,
1 VASISTAS LEGNO
2 WOODEN DOORS, 1 WOODEN DROP-DOWN DOOR,
1 WOODEN LIFT-UP DOOR

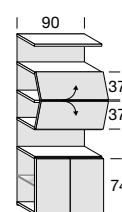

DCP5501M

2.723

MODULI L. 120
MODULES W. 120

2 ANTE LEGNO
2 WOODEN DOORS

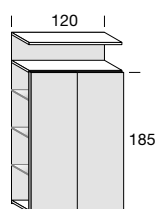

DCP6111M

NOCE-FRASSINO / WALNUT-ASHWOOD

2.393

2 ANTE VETRO
2 GLASS DOORS

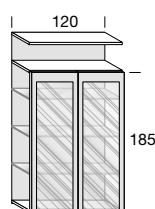

DCP6121M

2.393

2 ANTE LEGNO, 1 RIPIANO
2 WOODEN DOORS, 1 SHELF

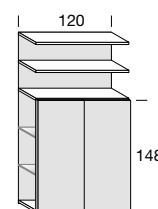

DCP6131M

2.399

1 CESTONE, 2 RIPIANI
1 BASKET, 2 SHELVES

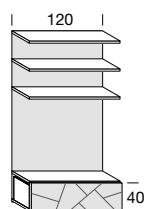

DCP5791M

NOCE-FRASSINO / WALNUT-ASHWOOD

2.314

1 CESTONE, 4 RIPIANI
1 BASKET, 4 SHELVES

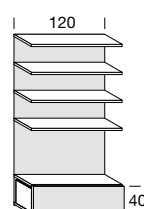

DCP5802M

2.393

1 CESTONE, 3 RIPIANI
1 BASKET, 3 SHELVES

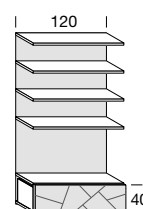

DCP5801M

2.621

1 CESTONE, 1 RIBALTA DECORATA,
1 VASISTAS LEGNO
1 BASKET, 1 DECORATED DROP-DOWN DOOR,
1 WOODEN LIFT-UP DOOR

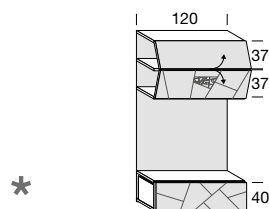

DCP5691M

NOCE-FRASSINO / WALNUT-ASHWOOD

3.349

4 ANTE LEGNO, 1 RIPIANO
4 WOODEN DOORS, 1 SHELF

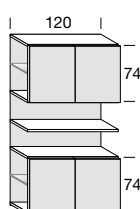

DCP5832M

2.867

4 ANTE DECORATE, 1 RIPIANO
4 DECORATED DOORS, 1 SHELF

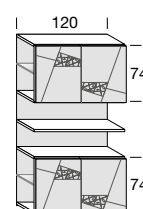

DCP5831M

3.540

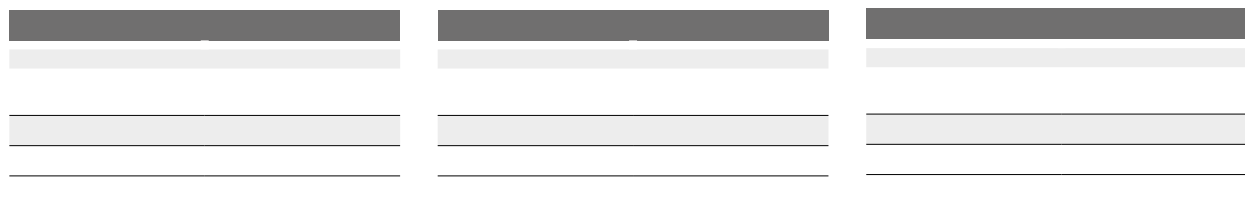

2 ANTE VETRO, 1 RIPIANO
2 GLASS DOORS, 1 SHELF

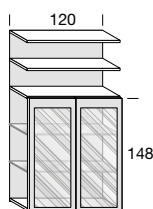

DCP6141M

2.399

1 CASSETTO, 2 RIPIANI
1 DRAWER, 2 SHELVES

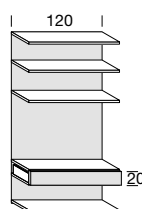

DCP5781M

2.230

1 CESTONE, 1 VASISTAS LEGNO
1 BASKET, 1 WOODEN LIFT-UP DOOR

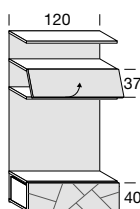

DCP5641M

2.675

1 CESTONE, 1 VASISTAS VETRO
1 BASKET, 1 GLASS LIFT-UP DOOR

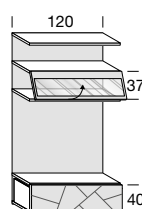

DCP5651M

2.675

1 CESTONE, 1 VASISTAS DECORATA
1 BASKET, 1 DECORATED LIFT-UP DOOR

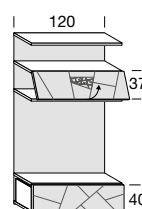

DCP5661M

2.994

2 ANTE LEGNO, 1 RIPIANO,
2 ANTE VETRO
2 WOODEN DOORS, 1 SHELF,
2 GLASS DOORS

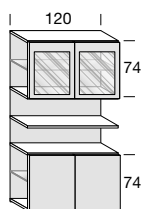

DCP5842M

2.867

2 ANTE DECORATE/TRAFORATE, 1 RIPIANO,
2 ANTE LEGNO
2 DECORATED/PERFORATED DOORS, 1 SHELF,
2 WOODEN DOORS

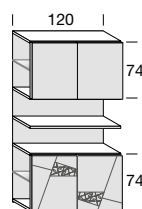

DCP5833M

3.204

EL. STRUTTURALI E OPTIONAL OPTIONAL AND STRUCTURAL EL.

FIANCO A TERRA SP. 3
FLOOR-STANDING SIDE PANEL TH. 3



PFP1031C

433

mc 0,04 - Kg 2

DIVISIONE A TERRA SP. 3
FLOOR-STANDING PARTITION TH. 3



PFP1071C

446

mc 0,04 - Kg 2

BARRA LED A BASSO CONSUMO
ACCENSIONE TOUCH
IN ALLUMINIO L. 37.2
LOW CONSUMPTION LED BAR
TOUCH SWITCH
IN ALUMINIUM W. 37.2



ZZZFE22001

163

ALIMENTATORE
POWER SUPPLY



ZZZFE22002

67

COLLEGAMENTO
A CARICO DEL CLIENTE
CONNECTIONS
TO BE MADE BY THE CUSTOMER.

*
SPECIFICARE CON O SENZA DECORO
FOGLIA
(IL PREZZO È LO STESSO)
PLEASE SPECIFY WITH OR WITHOUT
LEAF DECORATION
(THE PRICE IS THE SAME)

POSSIBILITÀ DI FRONTALE DIVERSO
DALLA SCOCCA, SPECIFICARE LA
FINITURA SCELTA

IN CASE OF FRONT DIFERENT FROM
THE CARCASE CONSIDER THE
HIGHER PRICE OF THE CHOSEN
FINISH

DECOR SISTEMA PARETE - WALL SYSTEM

MODULI A COLONNA H. 226.5 – P. 40

TALL UNIT MODULES H. 226.5 – D. 40

MODULI L. 120 MODULES W. 120

2 ANTE DECORATE/TRAFORATE, 1 RIPIANO,
2 ANTE VETRO
2 DECORATED/PERFORATED DOORS, 1 SHELF,
2 GLASS DOORS

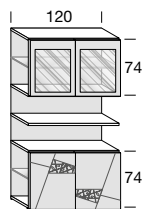

DCP5841M

6 ANTE LEGNO
6 WOODEN DOORS

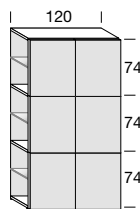

DCP5762M

6 ANTE VETRO
6 GLASS DOORS

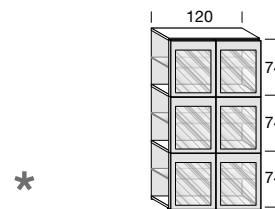

*

DCP5772M

NOCE-FRASSINO / WALNUT-ASHWOOD

3.204

3.276

3.276

1 CESTONE, 4 ANTE LEGNO
1 BASKET, 4 WOODEN DOORS

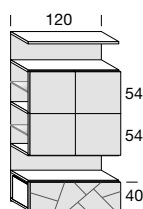

*

DCP2801M

1 CESTONE, 4 ANTE VETRO
1 BASKET, 4 GLASS DOORS

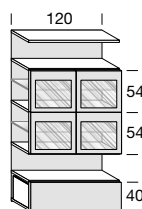

DCP2832M

1 CESTONE, 4 ANTE VETRO
1 BASKET, 4 GLASS DOORS

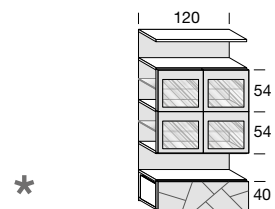

*

DCP2831M

NOCE-FRASSINO / WALNUT-ASHWOOD

3.674

3.529

3.674

1 CESTONE, 2 ANTE LEGNO,
2 ANTE VETRO
1 BASKET, 2 WOODEN DOORS,
2 GLASS DOORS

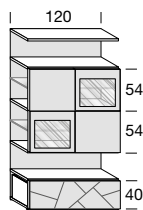

DCP2851M

1 CESTONE, 2 ANTE LEGNO,
2 ANTE DECORATE/TRAFORATE
1 BASKET, 2 WOODEN DOORS,
2 DECORATED/PERFORATED DOORS

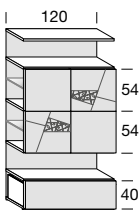

*

DCP2862M

1 CESTONE, 2 ANTE LEGNO,
2 ANTE DECORATE
1 BASKET, 2 WOODEN DOORS,
2 DECORATED DOORS

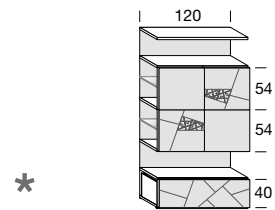

*

DCP2861M

NOCE-FRASSINO / WALNUT-ASHWOOD

3.674

3.836

4.141

MODULI TV L. 140 TV MODULES W. 140

1 CESTONE, 1 RIPIANO
1 BASKET, 1 SHELF

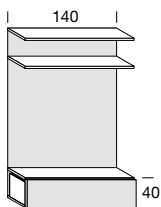

DCP2902M

1 CESTONE, 1 RIPIANO
1 BASKET, 1 SHELF

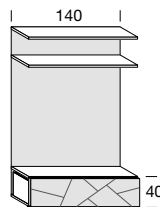

DCP2901M

1 CESTONE, 1 VASISTAS DECORATA
1 BASKET, 1 WOODEN LIFT-UP DOOR

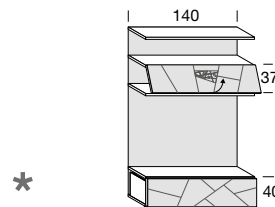

*

DCP2912M

NOCE-FRASSINO / WALNUT-ASHWOOD

1.875

2.567

3.583

2 ANTE LEGNO, 4 ANTE VETRO
2 WOODEN DOORS, 4 GLASS DOORS

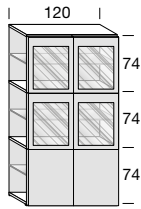

*

DCP5771M

3.276

2 ANTE LEGNO, 2 ANTE DECORATE/TRAFORATE,
2 ANTE VETRO
2 WOODEN DOORS, 2 DECORATED/PERFORATED DOORS,
2 GLASS DOORS

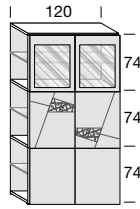

DCP5773M

3.607

1 CESTONE, 4 ANTE LEGNO
1 BASKET, 4 WOODEN DOORS

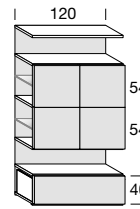

DCP2802M

3.529

1 CESTONE, 4 ANTE DECORATE/TRAFORATE
1 BASKET, 4 DECORATED/PERFORATED DOORS

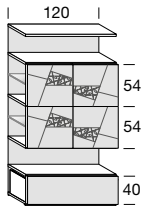

*

DCP2842M

4.141

1 CESTONE, 4 ANTE DECORATE
1 BASKET, 4 DECORATED DOORS

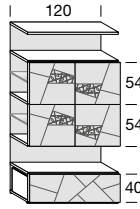

DCP2841M

4.292

1 CESTONE, 2 ANTE LEGNO,
2 ANTE VETRO
1 BASKET, 2 WOODEN DOORS,
2 GLASS DOORS

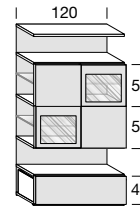

DCP2852M

3.529

1 CESTONE, 2 ANTE VETRO,
2 ANTE DECORATE/TRAFORATE
1 BASKET, 2 GLASS DOORS,
2 DECORATED/PERFORATED DOORS

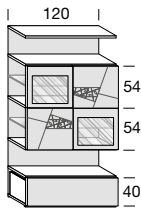

*

DCP2872M

3.836

1 CESTONE, 2 ANTE VETRO,
2 ANTE DECORATE
1 BASKET, 2 GLASS DOORS,
2 DECORATED DOORS

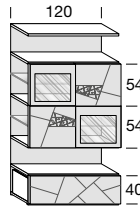

*

DCP2871M

4.141

1 CESTONE, 1 VASISTAS VETRO
1 BASKET, 1 GLASS LIFT-UP DOOR

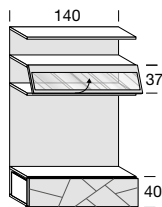

DCP2911M

3.259

EL. STRUTTURALI E OPTIONAL OPTIONAL AND STRUCTURAL EL.

FIANCO A TERRA SP. 3
FLOOR-STANDING SIDE PANEL TH. 3



PFP1031C

433

mc 0,04 – Kg 2

DIVISIONE A TERRA SP. 3
FLOOR-STANDING PARTITION TH. 3



PFP1071C

446

mc 0,04 – Kg 2

BARRA LED A BASSO CONSUMO
ACCENSIONE TOUCH
IN ALLUMINIO L. 37.2
LOW CONSUMPTION LED BAR
TOUCH SWITCH
IN ALUMINIUM W. 37.2



ZZZFE22001

163

ALIMENTATORE
POWER SUPPLY



ZZZFE22002

67

COLLEGAMENTO
A CARICO DEL CLIENTE
CONNECTIONS
TO BE MADE BY THE CUSTOMER.

*
SPECIFICARE CON O SENZA DECORO
FOGLIA
(IL PREZZO È LO STESSO)
PLEASE SPECIFY WITH OR WITHOUT
LEAF DECORATION
(THE PRICE IS THE SAME)

POSSIBILITÀ DI FRONTALE DIVERSO
DALLA SCOCCA, SPECIFICARE LA
FINITURA SCELTA

IN CASE OF FRONT DIFERENT FROM
THE CARCASE CONSIDER THE
HIGHER PRICE OF THE CHOOSEN
FINISH

DECOR SISTEMA PARETE - WALL SYSTEM

MODULI A COLONNA H. 226.5 – P. 40

TALL UNIT MODULES H. 226.5 – D. 40

MODULI L. 180
MODULES W. 180

2 CASSETTI, 2 RIPIANI
2 DRAWERS, 2 SHELVES

2 CESTONI, 2 RIPIANI
2 BASKETS, 2 SHELVES

2 CESTONI, 2 RIPIANI
2 BASKETS, 2 SHELVES

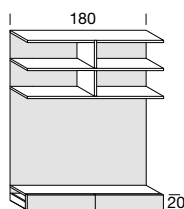

DCP5851M

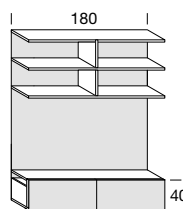

DCP5862M

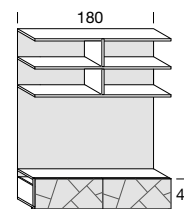

DCP5863M

NOCE-FRASSINO / WALNUT-ASHWOOD

3.259

3.588

3.817

COMPOSIZIONI HOME THEATRE H. 226.5 – P. 40/50

HOME THEATRE COMPOSITIONS H. 226.5 – D. 40/50

MODULI H. 226.5
MODULES H. 226.5

BASE 2 CESTONI, 1 ANTA VETRO, 1 ANTA DECORATA,
1 VASISTAS VETRO, 1 LIBRERIA
BASE UNIT WITH 2 BASKETS, 1 GLASS DOOR, 1 DECORATED DOOR,
1 GLASS LIFT-UP DOOR, 1 BOOKCASE

BASE 2 CESTONI, 1 ANTA VETRO, 1 RIBALTA VETRO,
1 VASISTAS LEGNO, 1 LIBRERIA
BASE UNIT WITH 2 BASKETS, 1 GLASS DOOR, 1 GLASS DROP-DOWN DOOR,
1 WOODEN LIFT-UP DOOR, 1 BOOKCASE

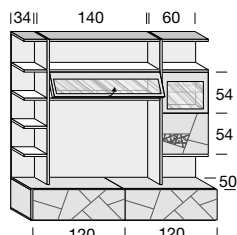

DCP1141M

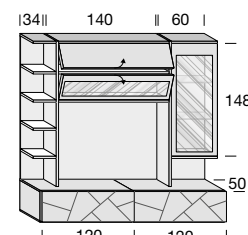

DCP1151M

*

NOCE-FRASSINO / WALNUT-ASHWOOD

7.737

7.658

BASE 2 CESTONI, 2 RIPIANI, 2 ANTE DECORATE, 1 VASISTAS DECORATA

BASE UNIT WITH 2 BASKETS, 2 SHELVES, 2 DECORATED DOORS, 1 DECORATED LIFT-UP DOOR

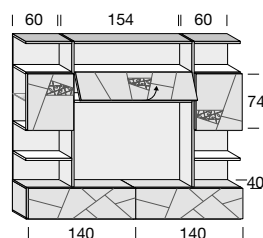

DCP1171M

NOCE-FRASSINO / WALNUT-ASHWOOD

9.227

N.B.: INDICARE SEMPRE IL VERSO DELL'ANTA (DX O SX)
N.B.: ALWAYS INDICATE THE DIRECTION OF DOOR (RH OR LH)

MODULO PONTE L. 180 OVERHEAD MODULE W. 180

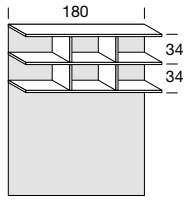

PFP9751M

NOCE-FRASSINO / WALNUT-ASHWOOD

2.026

N.B.: INDICARE SEMPRE IL VERSO DELLA COMPOSIZIONE (DX O SX)
N.B.: ALWAYS INDICATE THE DIRECTION OF COMPOSITION (RH OR LH)

BASE 2 CESTONI, 1 ANTA VETRO,
 1 VASISTAS VETRO, 1 LIBRERIA,, 1 RIPIANO
 BASE UNIT WITH 2 BASKETS, 1 GLASS DOOR,
 1 GLASS LIFT-UP DOOR, 1 BOOKCASE, 1 SHELF

BASE 2 CESTONI, 1 ANTA VETRO 1 RIBALTA VETRO, 1 VASISTAS LEGNO, 1 LIBRERIA
 BASE UNIT WITH 2 BASKETS, 1 GLASS DOOR, 1 GLASS DROP-DOWN DOOR,
 1 WOODEN LIFT-UP DOOR, 1 BOOKCASE

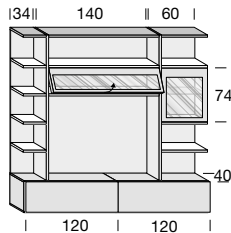

DCP1081M

6.823

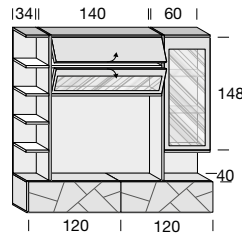

DCP1121M

7.569

EL. STRUTTURALI E OPTIONAL OPTIONAL AND STRUCTURAL EL.

FIANCO A TERRA SP. 3
FLOOR-STANDING SIDE PANEL TH. 3



PFP1031C

433

mc 0,04 – Kg 2

DIVISIONE A TERRA SP. 3
FLOOR-STANDING PARTITION TH. 3



PFP1071C

446

mc 0,04 – Kg 2

BARRA LED A BASSO CONSUMO
ACCENSIONE TOUCH
IN ALLUMINIO L. 37.2
LOW CONSUMPTION LED BAR
TOUCH SWITCH
IN ALUMINIUM W. 37.2



ZZZFE22001

163

ALIMENTATORE
POWER SUPPLY



ZZZFE22002

67

COLLEGAMENTO
A CARICO DEL CLIENTE
CONNECTIONS
TO BE MADE BY THE CUSTOMER.

SPECIFICARE CON O SENZA DECORO
FOGLIA
(IL PREZZO È LO STESSO)
PLEASE SPECIFY WITH OR WITHOUT
LEAF DECORATION
(THE PRICE IS THE SAME)

POSSIBILITÀ DI FRONTALE DIVERSO
DALLA SCOCCA, SPECIFICARE LA
FINITURA SCELTA
IN CASE OF FRONT DIFERENT FROM
THE CARCASE CONSIDER THE
HIGHER PRICE OF THE CHOOSEN
FINISH

DECOR SISTEMA PARETE - WALL SYSTEM

COMPOSIZIONI A CATALOGO

CATALOGUE COMPOSITIONS

POSSIBILITÀ DI FRONTALE DIVERSO DALLA SCOCCA, SPECIFICARE LA FINITURA SCELTA
IN CASE OF FRONT DIFFERENT FROM THE CARCASE CONSIDER THE HIGHER PRICE OF THE CHOOSEN FINISH

Per le composizioni a catalogo delle pareti Decor: il prezzo di listino indicato è bloccato, applicabile solamente a composizioni come da foto/disegno riportato.

Qualsiasi modifica delle composizioni proposte comporta l'annullamento di quanto sopra riportato; il prezzo deve essere calcolato sommando ogni singolo elemento.

The catalogue wall system compositions of Decor: have a fixed price applicable only to compositions as shown in the photo or technical drawing.

Any modification of the proposed compositions entails the calculation of the price adding the price of all elements that compose it.

COMPOSIZIONE 236

COMPOSITION 236

PAG. 95 CATALOGO "PROPOSTE ARREDATIVE"
PAGE 95 "FURNISHING SOLUTIONS" CATALOGUE

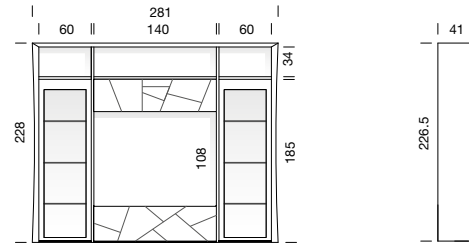
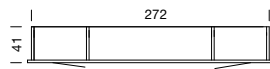

NOCE
FRASSINO

8.031

DCP0236K

PREZZO TOTALE COMPOSIZIONE
TOTAL PRICE FOR COMPOSITION

- 2 MODULO L 60 CON ANTA VETRO E VANO A GIORNO
MODULE W 60 WITH GLASS DOOR AND OPEN COMPARTMENT
- 1 MODULO L 140 CON CESTONE DECORATO E ANTA VASISTAS DECORATA
MODULE W 140 WITH DECORATED BASKET AND DECORATED LIFT-UP DOOR
- 2 DIVISIONE A TERRA H 226,5
FLOOR-STANDING PARTITION H 226,5
- 2 FIANCO A TERRA H 226,5
FLOOR-STANDING SIDE PANEL H 226,5
- 1 CORNICE PERIMETRALE H 228
PERIMETRIC FRAME H 228

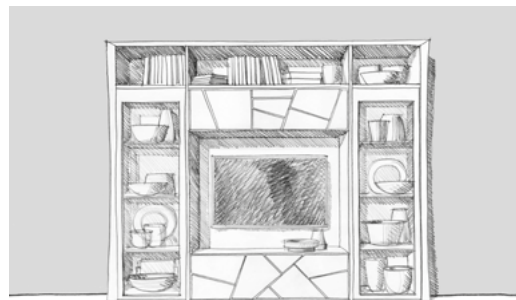

L. W. 281
H. H. 228
P. D. 41

COMPOSIZIONE 238

COMPOSITION 238

PAG. 96 CATALOGO "PROPOSTE ARREDATIVE"
PAGE 96 "FURNISHING SOLUTIONS" CATALOGUE

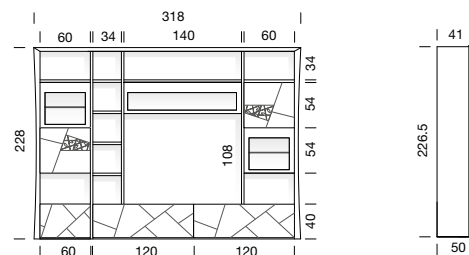
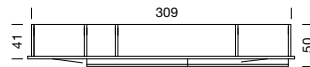

NOCE
FRASSINO

11.162

DCP0238K

PREZZO TOTALE COMPOSIZIONE
TOTAL PRICE FOR COMPOSITION

- 1 MODULO HOME THEATRE L 240 CON 2 BASI CESTONE DECORATO, 4 RIPIANI A GIORNO, ANTA VASISTAS VETRO, ANTA VETRO E ANTA DECORATA
HOME THEATRE MODULE W 240 WITH 2 BASE UNITS WITH DECORATED BASKET, 4 OPEN SHELVES, GLASS LIFT-UP DOOR, GLASS DOOR AND DECORATED DOOR
- 1 MODULO L 60 CON CESTONE DECORATO, ANTA VETRO E ANTA DECORATA
MODULE W 60 WITH DECORATED BASKET, GLASS DOOR AND DECORATED DOOR
- 1 DIVISIONE A TERRA H 226,5
FLOOR-STANDING PARTITION H 226,5
- 2 FIANCO A TERRA H 226,5
FLOOR-STANDING SIDE PANEL H 226,5
- 1 CORNICE PERIMETRALE H 228
PERIMETRIC FRAME H 228



L. W. 318
H. H. 228
P. D. 41/50

COMPOSIZIONI A CATALOGO CATALOGUE COMPOSITIONS

POSSIBILITÀ DI FRONTALE DIVERSO DALLA SCOCCA, SPECIFICARE LA FINITURA SCELTA
IN CASE OF FRONT DIFFERENT FROM THE CARCASE CONSIDER THE HIGHER PRICE OF THE CHOOSEN FINISH

COMPOSIZIONE 240 COMPOSITION 240

PAG. 97 CATALOGO "PROPOSTE ARREDATIVE"
PAGE 97 "FURNISHING SOLUTIONS" CATALOGUE

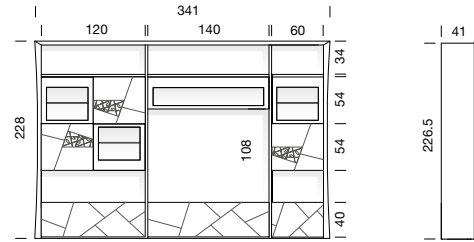
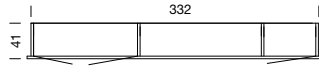

	NOCE FRASSINO
DCP0240K	PREZZO TOTALE COMPOSIZIONE TOTAL PRICE FOR COMPOSITION
	11.078

- 1 MODULO L 120 CON CESTONE DECORATO, 2 ANTE VETRO E 2 ANTE DECORATE CON DECORO FOGLIA
MODULE W 120 WITH DECORATED BASKET, 2 GLASS DOORS AND 2 DOORS WITH LEAF DECORATION
- 1 MODULO L 140 CON CESTONE DECORATO E ANTA VASISTAS VETRO
MODULE W 140 WITH DECORATED BASKET AND GLASS LIFT-UP DOOR
- 1 MODULO L 60 CON 1 CESTONE DECORATO, ANTA VETRO E ANTA DECORATA CON DECORO FOGLIA
MODULE W 60 WITH DECORATED BASKET, GLASS DOOR AND DOOR WITH LEAF DECORATION
- 2 DIVISIONE A TERRA H 226,5
FLOOR-STANDING PARTITION H 226,5
- 2 FIANCO A TERRA H 226,5
FLOOR-STANDING SIDE PANEL H 226,5
- 1 CORNICE PERIMETRALE H 228
PERIMETRIC FRAME H 228

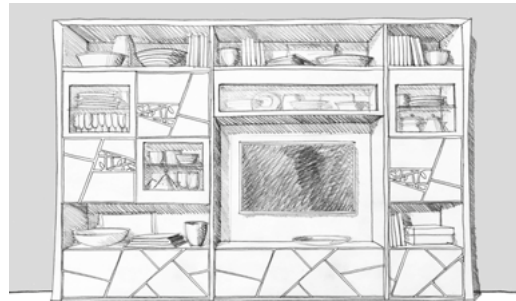

L. W. 341
H. H. 228
P. D. 41

COMPOSIZIONE 242 COMPOSITION 242

PAG. 98 CATALOGO "PROPOSTE ARREDATIVE"
PAGE 98 "FURNISHING SOLUTIONS" CATALOGUE

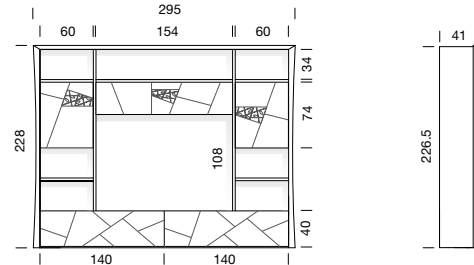
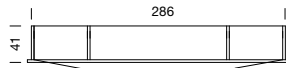

	NOCE FRASSINO
DCP0242K	PREZZO TOTALE COMPOSIZIONE TOTAL PRICE FOR COMPOSITION
	9.996

- 1 MODULO HOME THEATRE L 280 CON 2 BASI CESTONE DECORATO, 2 ANTE DECORATE E ANTA VASISTAS DECORATA CON DECORO FOGLIA
HOME THEATRE MODULE W 280 WITH 2 BASE UNITS WITH DECORATED BASKET, 2 DECORATED DOORS AND LIFT-UP DOOR WITH LEAF DECORATION
- 2 FIANCO A TERRA H 226,5
FLOOR-STANDING SIDE PANEL H 226,5
- 1 CORNICE PERIMETRALE H 228
PERIMETRIC FRAME H 228

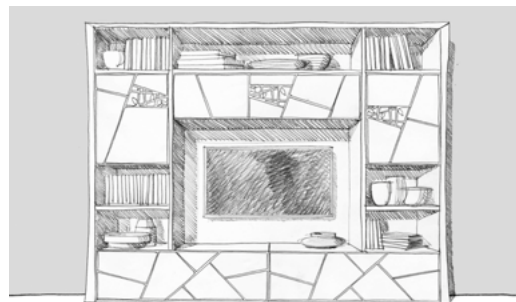

L. W. 295
H. H. 228
P. D. 41

COMPOSIZIONE 244 COMPOSITION 244

PAG. 99 CATALOGO "PROPOSTE ARREDATIVE"
PAGE 99 "FURNISHING SOLUTIONS" CATALOGUE

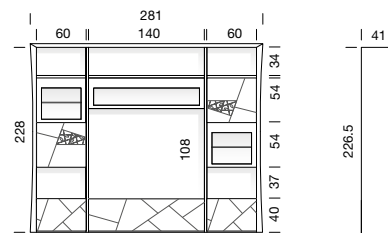
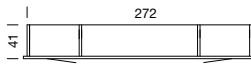

	NOCE FRASSINO
DCP0244K	PREZZO TOTALE COMPOSIZIONE TOTAL PRICE FOR COMPOSITION
	9.521

- 2 MODULO L 60 H 226,5 CON CESTONE DECORATO, ANTA VETRO E ANTA DECORATA CON DECORO FOGLIA
MODULE W 60 WITH DECORATED BASKET, GLASS DOOR AND DOOR WITH LEAF DECORATION
- 1 MODULO L 140 CON CESTONE DECORATO E ANTA VASISTAS VETRO
MODULE W 140 WITH DECORATED BASKET AND GLASS LIFT-UP DOOR
- 2 DIVISIONE A TERRA H 226,5
FLOOR-STANDING PARTITION H 226,5
- 2 FIANCO A TERRA H 226,5
FLOOR-STANDING SIDE PANEL H 226,5
- 1 CORNICE PERIMETRALE H 228
PERIMETRIC FRAME H 228

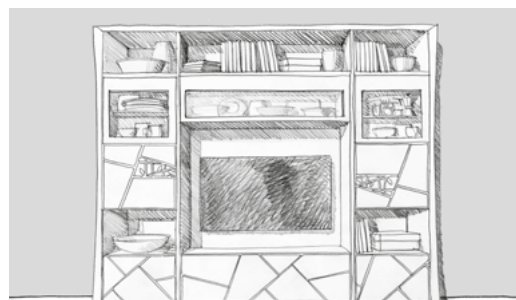

L. W. 281
H. H. 228
P. D. 41

DECOR SISTEMA PARETE - WALL SYSTEM

COMPOSIZIONI A CATALOGO

CATALOGUE COMPOSITIONS

POSSIBILITÀ DI FRONTALE DIVERSO DALLA SCOCCA, SPECIFICARE LA FINITURA SCELTA
IN CASE OF FRONT DIFFERENT FROM THE CARCASE, CONSIDER THE HIGHER PRICE OF THE CHOOSEN FINISH

COMPOSIZIONE 248

COMPOSITION 248

PAG. 101 CATALOGO "PROPOSTE ARREDATIVE"
PAGE 101 "FURNISHING SOLUTIONS" CATALOGUE

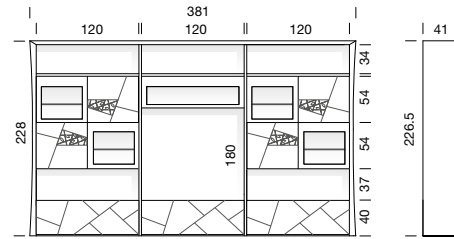
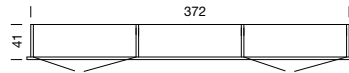

NOCE
FRASSINO

DCP048K

PREZZO TOTALE COMPOSIZIONE
TOTAL PRICE FOR COMPOSITION

12.647

- 2 MODULO L 120 CON CESTONE DECORATO, 2 ANTE VETRO E 2 ANTE DECORATE CON DECORO FOGLIA
MODULE W 120 WITH 1 DECORATED BASKET, 2 GLASS DOORS AND 2 DOORS WITH LEAF DECORATION
- 1 MODULO L 120 CON CESTONE DECORATO E ANTA VASISTAS VETRO
MODULE W 120 WITH DECORATED BASKET AND GLASS LIFT-UP DOOR
- 2 DIVISIONE A TERRA H 226,5
FLOOR-STANDING PARTITION H 226,5
- 2 FIANCO A TERRA H 226,5
FLOOR-STANDING SIDE PANEL H 226,5
- 1 CORNICE PERIMETRALE H 228
PERIMETRIC FRAME H 228

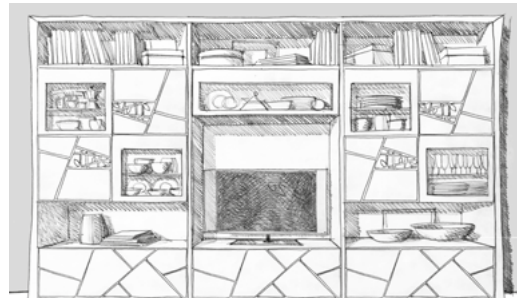

L. W. 381
H. H. 228
P. D. 41

COMPOSIZIONE 200

COMPOSITION 200

PAG. 102 CATALOGO "PROPOSTE ARREDATIVE"
PAGE 102 "FURNISHING SOLUTIONS" CATALOGUE

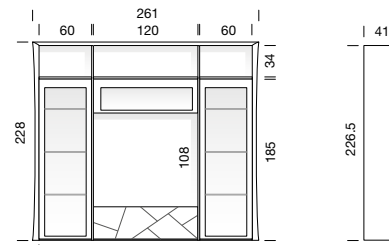
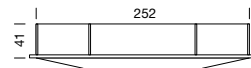

NOCE
FRASSINO

DCP0200K

PREZZO TOTALE COMPOSIZIONE
TOTAL PRICE FOR COMPOSITION

7.122

- 2 MODULO L 60 CON ANTA VETRO E VANO A GIORNO
MODULE W 60 WITH GLASS DOOR AND OPEN COMPART.
- 1 MODULO L 120 CON ANTA VETRO VASISTAS E CESTONE DECORATO
MODULE W 120 WITH GLASS LIFT-UP DOOR AND DECORATED BASKET
- 2 FIANCO A TERRA H 226,5
FLOOR-STANDING SIDE PANEL H 226,5
- 2 DIVISIONE A TERRA H 226,5
FLOOR-STANDING PARTITION H 226,5
- 1 CORNICE PERIMETRALE H 228
PERIMETRIC FRAME H 228

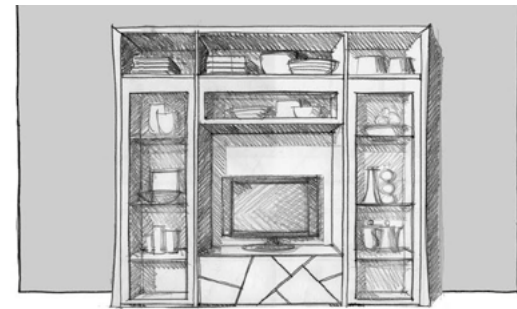

L. W. 261
H. H. 228
P. D. 41

COMPOSIZIONE 207

COMPOSITION 207

PAG. 103 CATALOGO "PROPOSTE ARREDATIVE"
PAGE 103 "FURNISHING SOLUTIONS" CATALOGUE

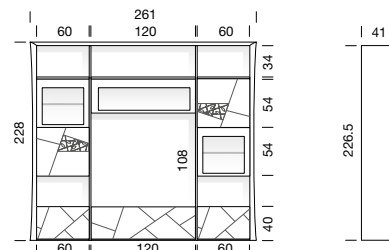
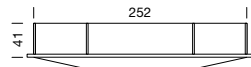

NOCE
FRASSINO

DCP0207K

PREZZO TOTALE COMPOSIZIONE
TOTAL PRICE FOR COMPOSITION

9.041

- 2 MODULI L 60 CON CESTONE, ANTA DECORATA CON DECORO FOGLIA E ANTA VETRO
MODULES W 60 WITH BASKET, DOOR WITH LEAF DECORATION AND GLASS DOOR
- 1 MODULO L 120 CON CESTONE E ANTA VASISTAS VETRO
MODULE W 120 WITH BASKET AND GLASS LIFT-UP DOOR
- 2 FIANCO A TERRA H 226,5
FLOOR-STANDING SIDE PANEL H 226,5
- 2 DIVISIONE A TERRA H 226,5
FLOOR-STANDING PARTITION H 226,5
- 1 CORNICE PERIMETRALE H 228
PERIMETRIC FRAME H 228

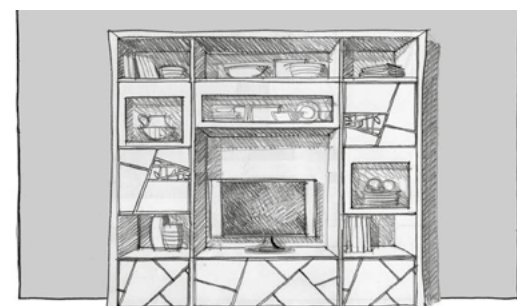

L. W. 261
H. H. 228
P. D. 41

COMPOSIZIONI A CATALOGO CATALOGUE COMPOSITIONS

POSSIBILITÀ DI FRONTALE DIVERSO DALLA SCOCCA, SPECIFICARE LA FINITURA SCELTA
IN CASE OF FRONT DIFFERENT FROM THE CARCASE, CONSIDER THE HIGHER PRICE OF THE CHOOSEN FINISH

COMPOSIZIONE 211 COMPOSITION 211

PAG. 104 CATALOGO "PROPOSTE ARREDATIVE"
PAGE 104 "FURNISHING SOLUTIONS" CATALOGUE

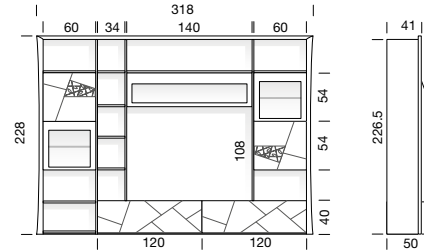
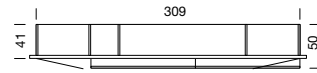

NOCE
FRASSINO

DCP0211K

PREZZO TOTALE COMPOSIZIONE
TOTAL PRICE FOR COMPOSITION

10.633

- 1 MODULO L 60 CON ANTA DECORATA CON DECORO FOGLIA E ANTA VETRO
MODULE W 60 WITH DOOR WITH LEAF DECORATION AND GLASS DOOR
- 1 MODULO HOME THEATRE L 240 CON 2 CESTONI, LIBRERIA, VANO TV CON VASISTAS VETRO E VANO CON ANTA DECORATA CON DECORO FOGLIA E ANTA VETRO
HOME THEATRE MODULE W 240 WITH 2 BASKETS, BOOKCASE, TV COMP. WITH GLASS LIFT-UP DOOR AND COMP WITH DOOR WITH LEAF DECORATION AND GLASS DOOR
- 2 FIANCO A TERRA H 226,5
FLOOR-STANDING SIDE PANEL H 226,5
- 1 DIVISIONE A TERRA H 226,5
FLOOR-STANDING PARTITION H 226,5
- 1 CORNICE PERIMETRALE H 228
PERIMETRIC FRAME H 228

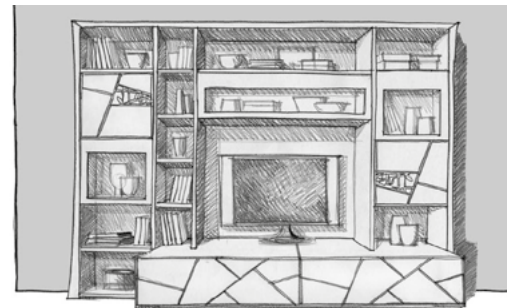

L. W. 318
H. H. 228
P. D. 41/50

COMPOSIZIONE 213 COMPOSITION 213

PAG. 105 CATALOGO "PROPOSTE ARREDATIVE"
PAGE 105 "FURNISHING SOLUTIONS" CATALOGUE

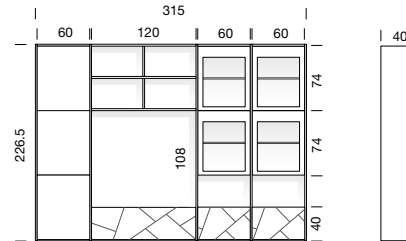
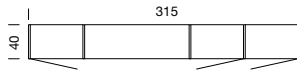

NOCE
FRASSINO

DCP0213K

PREZZO TOTALE COMPOSIZIONE
TOTAL PRICE FOR COMPOSITION

10.633

- 1 MODULO L 60 CON 3 ANTE LEGNO
MODULE W 60 WITH 3 WOODEN DOORS
- 1 MODULO L 120 CON CESTONE E VANI A GIORNO
MODULE W 120 WITH BASKET AND OPEN COMPART.
- 2 MODULO L 60 CON CESTONE E 2 ANTE VETRO
MODULE W 60 WITH BASKET AND 2 GLASS DOORS
- 2 FIANCO A TERRA H 226,5
FLOOR-STANDING SIDE PANEL H 226,5
- 3 DIVISIONE A TERRA H 226,5
FLOOR-STANDING PARTITION H 226,5

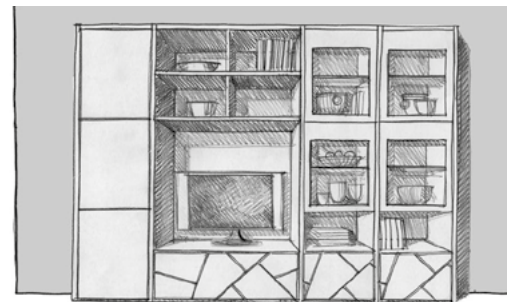

L. W. 315
H. H. 226,5
P. D. 40

COMPOSIZIONE 216 COMPOSITION 216

PAG. 86-87 CATALOGO "DECOR NEW" E
PAG. 106 CATALOGO "PROPOSTE ARREDATIVE"
PAGE 86-87 "DECOR NEW" AND
PAGE 106 "FURNISHING SOLUTIONS" CATALOGUE

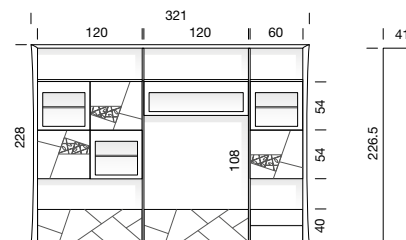
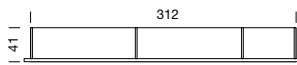

NOCE
FRASSINO

DCP0216K

PREZZO TOTALE COMPOSIZIONE
TOTAL PRICE FOR COMPOSITION

10.526

- 1 MODULO L 120 CON CESTONE, 2 ANTE DECORATE CON DECORO FOGLIA E 2 ANTE VETRO
MODULE W 120 WITH BASKET, 2 DOORS WITH LEAF DECORATION AND 2 GLASS DOORS
- 1 MODULO L 120 CON CESTONE E ANTA VASISTAS VETRO
MODULE W 120 WITH BASKET AND GLASS LIFT-UP DOOR
- 1 MODULO L 60 CON 2 CASSETTI, ANTA VETRO E ANTA DECORATA CON DECORO FOGLIA
MODULE W 60 WITH 2 DRAWERS, GLASS DOOR AND DOOR WITH LEAF DECORATION
- 2 FIANCO A TERRA H 226,5
FLOOR-STANDING SIDE PANEL H 226,5
- 2 DIVISIONE A TERRA H 226,5
FLOOR-STANDING PARTITION H 226,5
- 1 CORNICE PERIMETRALE H 228
PERIMETRIC FRAME H 228

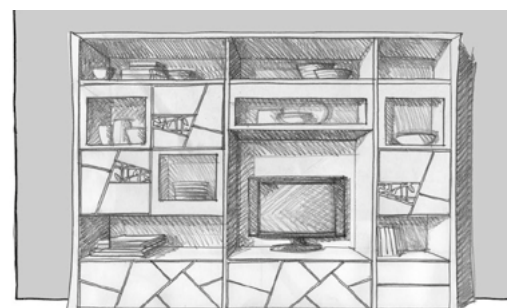

L. W. 321
H. H. 228
P. D. 41

DECOR SISTEMA PARETE - WALL SYSTEM

COMPOSIZIONI A CATALOGO

CATALOGUE COMPOSITIONS

POSSIBILITÀ DI FRONTALE DIVERSO DALLA SCOCCA, SPECIFICARE LA FINITURA SCELTA

IN CASE OF FRONT DIFFERENT FROM THE CARCASE CONSIDER THE HIGHER PRICE OF THE CHOSEN FINISH

COMPOSIZIONE 219/A

COMPOSITION 219/A

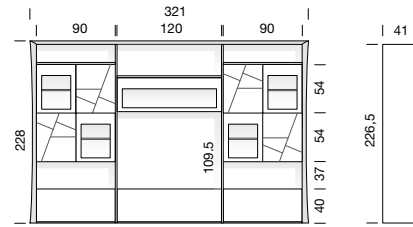
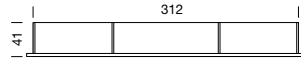

NOCE
FRASSINO

DCP0219K

PREZZO TOTALE COMPOSIZIONE
TOTAL PRICE FOR COMPOSITION

10.585

- 2 MODULI L 90 CON CESTONE, 2 ANTE DECORATE E 2 ANTE VETRO
MODULES W 90 WITH BASKET, 2 DECORATED DOORS AND 2 GLASS DOORS
- 1 MODULO L 120 CON CESTONE E ANTA VASISTAS VETRO
MODULE W 120 WITH BASKET AND GLASS LIFT-UP DOOR
- 2 FIANCO A TERRA H 226,5
FLOOR-STANDING SIDE PANEL H 226,5
- 2 DIVISIONE A TERRA H 226,5
FLOOR-STANDING PARTITION H 226,5
- 1 CORNICE PERIMETRALE H 228
PERIMETRIC FRAME H 228

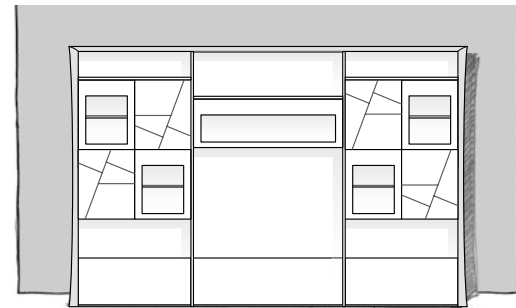

L. W. 321
H. H. 228
P. D. 41

COMPOSIZIONE 221

COMPOSITION 221

PAG. 107 CATALOGO "PROPOSTE ARREDATIVE"
PAGE 107 "FURNISHING SOLUTIONS" CATALOGUE

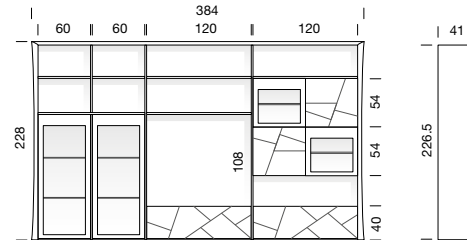
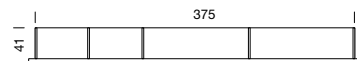

NOCE
FRASSINO

DCP0221K

PREZZO TOTALE COMPOSIZIONE
TOTAL PRICE FOR COMPOSITION

11.055

- 2 MODULI L 60 CON ANTA VETRO E VANI A GIORNO
MODULES W 60 WITH GLASS DOOR AND OPEN COMPARTMENTS
- 1 MODULO L 120 CON CESTONE E VANI A GIORNO
MODULE W 120 WITH BASKET AND OPEN COMPART.
- 1 MODULO L 120 CON CESTONE, 2 ANTE DECORATE E 2 ANTE VETRO
MODULE W 120 WITH BASKET, 2 DECORATED DOORS AND 2 GLASS DOORS
- 2 FIANCO A TERRA H 226,5
FLOOR-STANDING SIDE PANEL H 226,5
- 3 DIVISIONE A TERRA H 226,5
FLOOR-STANDING PARTITION H 226,5
- 1 CORNICE PERIMETRALE H 228
PERIMETRIC FRAME H 228

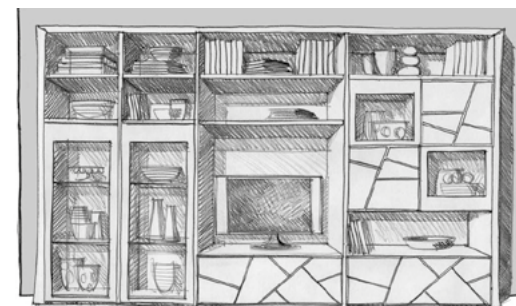

L. W. 384
H. H. 228
P. D. 41

COMPOSIZIONE 223

COMPOSITION 223

PAG. 108 CATALOGO "PROPOSTE ARREDATIVE"
PAGE 108 "FURNISHING SOLUTIONS" CATALOGUE

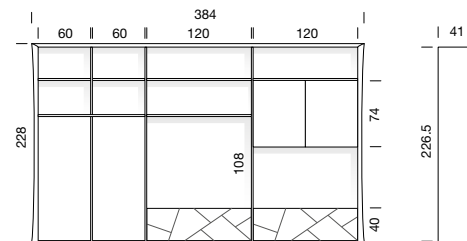
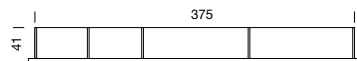

NOCE
FRASSINO

DCP0223K

PREZZO TOTALE COMPOSIZIONE
TOTAL PRICE FOR COMPOSITION

9.978

- 2 MODULI L 60 CON ANTA LEGNO A VANI A GIORNO
MODULES W 60 WITH WOODEN DOOR AND OPEN COMPARTMENTS
- 1 MODULO L 120 CON CESTONE E VANI A GIORNO
MODULE W 120 WITH BASKET AND OPEN COMPARTMENTS
- 1 MODULO L 120 CON CESTONE E 2 ANTE LEGNO
MODULE W 120 WITH BASKET AND 2 WOODEN DOORS
- 2 FIANCO A TERRA H 226,5
FLOOR-STANDING SIDE PANEL H 226,5
- 3 DIVISIONE A TERRA H 226,5
FLOOR-STANDING PARTITION H 226,5
- 1 CORNICE PERIMETRALE H 228
PERIMETRIC FRAME H 228

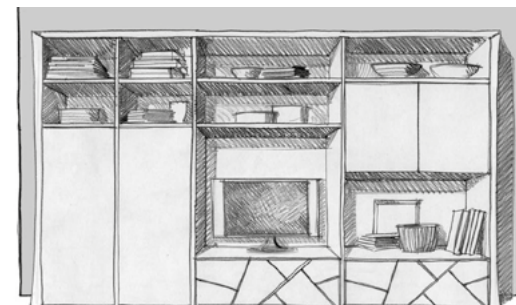

L. W. 384
H. H. 228
P. D. 41

COMPOSIZIONI A CATALOGO CATALOGUE COMPOSITIONS

POSSIBILITÀ DI FRONTALE DIVERSO DALLA SCOCCA, SPECIFICARE LA FINITURA SCELTA
IN CASE OF FRONT DIFFERENT FROM THE CARCASE CONSIDER THE HIGHER PRICE OF THE CHOOSEN FINISH

COMPOSIZIONE 224 COMPOSITION 224

PAG. 109 CATALOGO "PROPOSTE ARREDATIVE"
PAGE 109 "FURNISHING SOLUTIONS" CATALOGUE

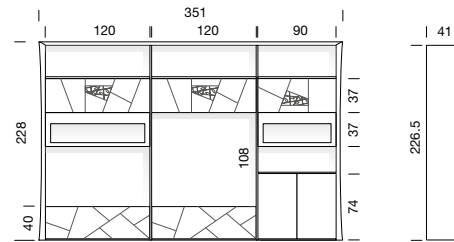
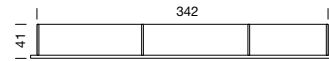

NOCE
FRASSINO

DCP0224K

PREZZO TOTALE COMPOSIZIONE
TOTAL PRICE FOR COMPOSITION

11.078

- 1 MODULO L 120 CON CESTONE, ANTA VASISTAS DECORATA CON DECORO FOGLIA E ANTA RIBALTA VETRO
MODULE W 120 WITH BASKET, LIFT-UP DOOR WITH LEAF DECORATION AND GLASS DROP-DOWN DOORS
- 1 MODULO L 120 CON CESTONE E ANTA VASISTAS DECORATA CON DECORO FOGLIA
MODULE W 120 WITH BASKET AND LIFT-UP DOOR WITH LEAF DECORATION
- 1 MODULO L 90 CON 2 ANTE LEGNO, ANTA VASISTAS DECORATA CON DECORO FOGLIA E ANTA RIBALTA VETRO
MODULE W 90 WITH 2 WOODEN DOORS, LIFT-UP DOOR WITH LEAF DECORATION AND GLASS DROP-DOWN DOOR
- 2 FIANCO A TERRA H 226,5
FLOOR-STANDING SIDE PANEL H 226,5
- 2 DIVISIONE A TERRA H 226,5
FLOOR-STANDING PARTITION H 226,5
- 1 CORNICE PERIMETRALE H 228
PERIMETRIC FRAME H 228

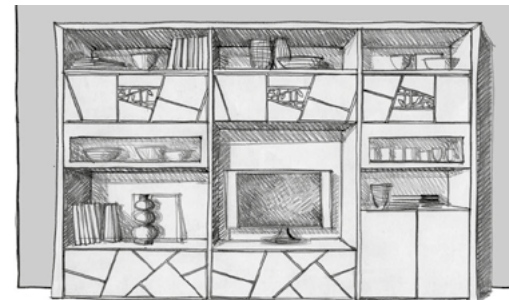

L. W. 351
H. H. 228
P. D. 41

COMPOSIZIONE 226 COMPOSITION 226

PAG. 22-23 CATALOGO "MODOZINE" E
PAG. 82-83 "DECOR NEW"
PAGE 22-23 "MODOZINE" AND
PAGE 82-83 "DECOR NEW" CATALOGUE

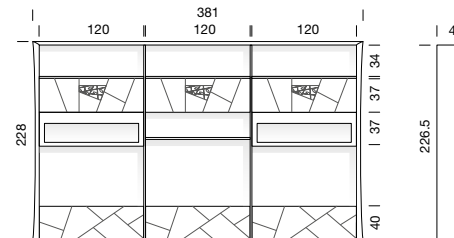
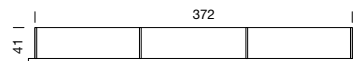

NOCE
FRASSINO

DCP0226K

PREZZO TOTALE COMPOSIZIONE
TOTAL PRICE FOR COMPOSITION

11.884

- 2 MODULI L 120 CON CESTONE, ANTA VASISTAS DECORATA CON DECORO FOGLIA E ANTA VETRO RIBALTA
MODULES W 120 WITH BASKET, LIFT-UP DOOR WITH LEAF DECORATION AND GLASS DROP-DOWN DOOR
- 1 MODULO L 120 CON CESTONE, ANTA VASISTAS DECORATA CON DECORO FOGLIA E RIPIANO
MODULE W 120 WITH BASKET, LIFT-UP DOOR WITH LEAF DECORATION AND 1 SHELF
- 2 FIANCO A TERRA H 226,5
FLOOR-STANDING SIDE PANEL H 226,5
- 2 DIVISIONI A TERRA H 226,5
FLOOR-STANDING PARTITIONS H 226,5
- 1 CORNICE PERIMETRALE H 228
PERIMETRIC FRAME H 228



L. W. 381
H. H. 228
P. D. 41

PORTOFINO NOTTE E GIORNO

PORTOFINO NIGHT AND DAY

CARATTERISTICHE TECNICHE TECHNICAL CHARACTERISTICS	150
LETTI BEDS	158
ARMADI WARDROBES	160
COMODINO, COMÒ, SETTIMINO, SPECCHIERA E TOILETTE BEDSIDE TABLE, CHEST OF DRAWERS, 7-DRAWER CHEST MIRROR AND DRESSING TABLE	164
VETRINE DISPLAY UNITS	165
CREDENZE, TAVOLI E SEDIE SIDEBOARDS, TABLES AND CHAIRS	166
CONSOLLE, PORTA TV E MADIE CONSOLE, TV UNIT AND CUPBOARDS	167
MADIE DISPLAY UNITS	168
COMPOSIZIONI A CATALOGO CATALOGUE COMPOSITIONS	170

PORTOFINO NOTTE - NIGHT

CARATTERISTICHE TECNICHE TECHNICAL CHARACTERISTICS

LETTI

PIEDE LEGNO

MASSELLO DI TIGLIO O FRASSINO INTAGLIATO SP. CM. 4 SAGOMATO, VERNICIATO O LACCATO A PORO APERTO.

PIEDE METALLO

FINITURA NICHEL LUCIDO.

TRAVERSO REGGIRETE

MASSELLO SP. CM. 4, REGOLABILE IN 4 ALTEZZE.

VERSIONE CONTENITORE

RETE A DOGHE DI FAGGIO CON MECCANISMO BASCULANTE O RETE A DOGHE CON MECCANISMO A SOLLEVAMENTO ORIZZONTALE (OPTIONAL) E FONDO DI CONTENIMENTO IN DECORATIVO SBIANCATO, SPAZIO UTILE H. CM. 12.

BEDS

WOODEN TOP

LINDEN SOLID WOOD OR CARVED SOLID ASHWOOD TH. CM. 4 SHAPED, PAINTED OR OPEN PORE LACQUERED.

METAL FOOT

GLOSSY NICKEL FINISH.

CROSS PIECE FOR BED BASE UNIT WITH SUPPORT

SOLID WOOD TH. CM. 4 ADJUSTABLE IN 4 HEIGHTS.

VERSION WITH STORAGE UNIT

BEECH SLATTED BED BASE WITH TILTING MECHANISM OR SLATTED BED BASE WITH HORIZONTAL LIFTING MECHANISM (OPTIONAL) AND STORAGE BOTTOM IN BLEACHED DECORATIVE, USEFUL SPACE H. CM. 12.

PORTOFINO



PANNELLO TRAFORATO
PERFORATED PANEL

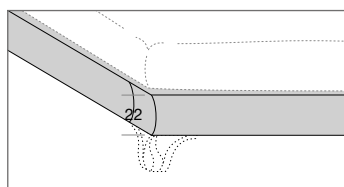

GIROLETTO IN LEGNO MASSELLO SAGOMATO
SOLID WOOD SHAPED BED SURROUND

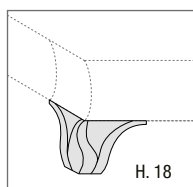

PIEDE LEGNO INTAGLIATO
CARVED WOODEN TOP

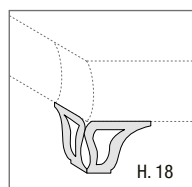

PIEDE METALLO TRAFORATO
AL LASER
METAL FOOT PERFORATED
WITH LASER

LETTO CON PANNELLO TRAFORATO

PROFILO

TESTIERA IN MASSELLO DI TOULIPIER O FRASSINO SPAZZOLATO SP. CM. 8 SAGOMATO, VERNICIATO O A LACCATO A PORO APERTO.

PANNELLO

TRAFORATO IN MULTISTRATO IMPIALLACCIATO IN TOULIPIER O FRASSINO SPAZZOLATO SP. CM. 1.4, VERNICIATO O LACCATO A PORO APERTO.

GIROLETTO E PIEDI

MASSELLO DI TIGLIO O FRASSINO SPAZZOLATO SP. CM. 5.5, VERNICIATO O LACCATO A PORO APERTO.

BED WITH PERFORATED PANEL

PROFILE

HEADBOARD IN TOULIPIER SOLID WOOD OR BRUSHED SOLID ASHWOOD TH. CM. 8 SHAPED, PAINTED OR OPEN PORE LACQUERED.

PANEL

PERFORATED IN MULTILAYER VENEERED IN TOULIPIER OR BRUSHED ASHWOOD TH. CM. 1.4, PAINTED OR OPEN PORE LACQUERED.

BED SURROUND AND FEET

LINDEN SOLID WOOD OR BRUSHED SOLID ASHWOOD TH. CM. 5.5, PAINTED OR OPEN PORE LACQUERED.

FRIDA



PANNELLO IMBOTTITO NON SFODERABILE
UPHOLSTERED PANEL WITHOUT REMOVABLE COVER

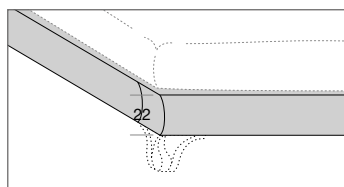

GIROLETTO IN LEGNO MASSELLO SAGOMATO
SOLID WOOD SHAPED BED SURROUND

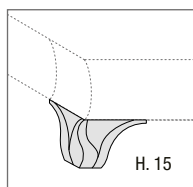

PIEDE LEGNO INTAGLIATO
CARVED WOODEN TOP

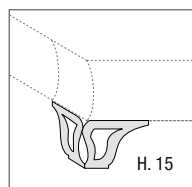

PIEDE METALLO TRAFORATO
AL LASER
METAL FOOT PERFORATED
WITH LASER

LETTO CON PANNELLO TESTIERA IMBOTTITO

PROFILO

TESTIERA IN MASSELLO DI TOULIPIER O FRASSINO SPAZZOLATO SP. CM. 6 CON PANNELLO DI LISTELLARE IMPIALLACCIATO IN NOCE TANGANICA O FRASSINO SP. CM. 2.5 VERNICIATO O LACCATO A PORO APERTO.

PANNELLO IMBOTTITO

PANNELLO IN MULTISTRATI DI PIOPPO SP. CM. 0.8 E IMBOTTITURA IN GOMMAPIUMA SP. CM. 0.8, RIVESTIMENTO DA CAMPIONARIO.

GIROLETTO E PIEDI

MASSELLO DI TIGLIO O FRASSINO SPAZZOLATO SP. CM. 5.5, VERNICIATO O LACCATO A PORO APERTO.

BED WITH UPHOLSTERED HEADBOARD PANEL

PROFILE

HEADBOARD IN TOULIPIER SOLID WOOD OR BRUSHED SOLID ASHWOOD TH. CM. 6 WITH BLOCKBOARD PANEL VENEERED IN TANGANICA WALNUT OR ASHWOOD TH. CM. 2.5 PAINTED OR OPEN PORE LACQUERED.

UPHOLSTERED PANEL

POPLAR MULTILAYER PANEL TH. CM. 0.8 AND UPHOLSTERED WITH FOAM RUBBER TH. CM. 0.8, COVERED WITH OUR RANGE FINISHES.

BED SURROUND AND FEET

LINDEN SOLID WOOD OR BRUSHED SOLID ASHWOOD TH. CM. 5.5, PAINTED OR OPEN PORE LACQUERED.

TEODORA

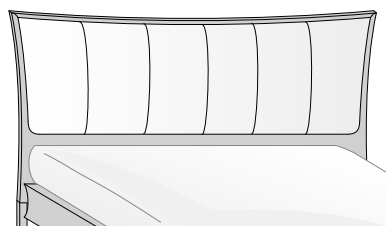

PANNELLO IMBOTTITO NON SFODERABILE
UPHOLSTERED PANEL WITHOUT REMOVABLE COVER

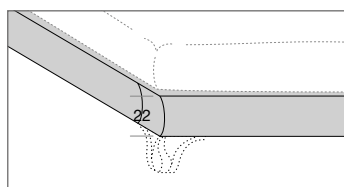

GIROLETTO IN LEGNO MASSELLO SAGOMATO
SOLID WOOD SHAPED BED SURROUND

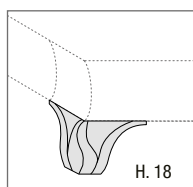

PIEDE LEGNO INTAGLIATO
CARVED WOODEN TOP

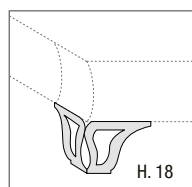

PIEDE METALLO TRAFORATO
AL LASER
METAL FOOT PERFORATED
WITH LASER

LETTO CON PANNELLO TESTIERA IMBOTTITO

PROFILO

TESTIERA IN MASSELLO DI TOULIPIER O FRASSINO SPAZZOLATO SP. CM. 11 SAGOMATO, VERNICIATO O LACCATO A PORO APERTO.

PANNELLO IMBOTTITO

PANNELLO IN MULTISTRATI PIOPPO SP. CM. 0.8 E IMBOTTITURA IN GOMMAPIUMA SP. CM. 0.8, RIVESTIMENTO DA CAMPIONARIO.

GIROLETTO

MASSELLO DI TIGLIO O FRASSINO SPAZZOLATO SP. CM. 5.5, VERNICIATO O LACCATO A PORO APERTO.

BED WITH UPHOLSTERED HEADBOARD PANEL

PROFILE

HEADBOARD IN TOULIPIER SOLID WOOD OR BRUSHED SOLID ASHWOOD TH. CM. 11 SHAPED, PAINTED OR OPEN PORE LACQUERED.

UPHOLSTERED PANEL

POPLAR MULTILAYER PANEL TH. CM. 0.8 AND UPHOLSTERED WITH FOAM RUBBER TH. CM. 0.8, COVERED WITH OUR RANGE FINISHES.

BED SURROUND

LINDEN SOLID WOOD OR BRUSHED SOLID ASHWOOD TH. CM. 5.5, PAINTED OR OPEN PORE LACQUERED.

LETTI

PIEDE LEGNO	MASSELLO DI TIGLIO O FRASSINO INTAGLIATO SP. CM. 4 SAGOMATO, VERNICIATO O LACCATO A PORO APERTO.
PIEDE METALLO	FINITURA NICHEL LUCIDO.
TRAVERSO REGGIRETE	MASSELLO SP. CM. 4, REGOLABILE IN 4 ALTEZZE.
VERSIONE CONTENITORE	RETE A DOGHE DI FAGGIO CON MECCANISMO BASCULANTE O RETE A DOGHE CON MECCANISMO A SOLLEVAMENTO ORIZZONTALE (OPTIONAL) E FONDO DI CONTENIMENTO IN DECORATIVO SBIANCATO, SPAZIO UTILE H. CM. 12.

BEDS

WOODEN TOP	LINDEN SOLID WOOD OR CARVED SOLID ASHWOOD TH. CM. 4 SHAPED, PAINTED OR OPEN PORE LACQUERED.
METAL FOOT	GLOSSY NICKEL FINISH.
CROSS PIECE FOR BED BASE UNIT WITH SUPPORT	SOLID WOOD TH. CM. 4 ADJUSTABLE IN 4 HEIGHTS.
VERSION WITH STORAGE UNIT	BEECH SLATTED BED BASE WITH TILTING MECHANISM OR SLATTED BED BASE WITH HORIZONTAL LIFTING MECHANISM (OPTIONAL) AND STORAGE BOTTOM IN BLEACHED DECORATIVE, USEFUL SPACE H. CM. 12.

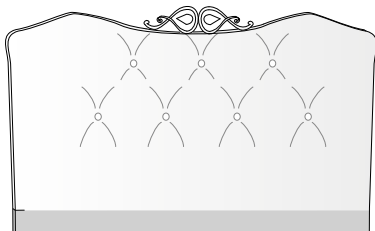

PANNELLO IMBOTTITO CON BOTTONI DECORATIVI E CIMASA LEGNO
UPHOLSTERED PANEL WITH DECORATION BUTTONS AND WOODEN MOULDING

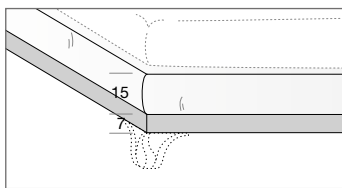

GIROLETTO SUPERIORE IMBOTTITO, GIROLETTO INFERIORE LEGNO
TOP UPHOLSTERED BED, WOODEN LOW BED SURROUND

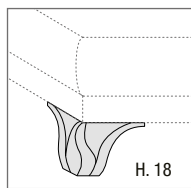

PIEDE LEGNO INTAGLIATO
CARVED WOODEN TOP

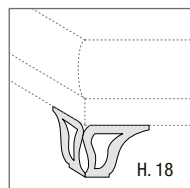

PIEDE METALLO TRAFORATO AL LASER
METAL FOOT PERFORATED WITH LASER

NEW

GIROLETTO PER MODELLO 'SIBILLA LIGHT'
BED SURROUND FOR 'SIBILLA LIGHT' MODEL

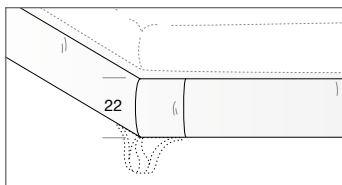

GIROLETTO IMBOTTITO
UPHOLSTERED BED SURROUND

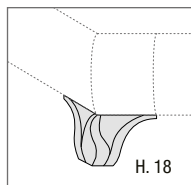

PIEDE LEGNO INTAGLIATO
CARVED WOODEN TOP

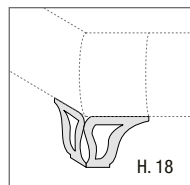

PIEDE METALLO TRAFORATO AL LASER
METAL FOOT PERFORATED WITH LASER

LETTO CON TESTIERA E GIROLETTO IMBOTTITI

STRUTTURA TESTIERA	MASSELLO E IN PANNELLO DI MULTISTRATI PIOPPO SP. CM. 2.5 IMBOTTITO IN GOMMAPIUMA E RIVESTITO DA CAMPIONARIO.
CIMASA TESTIERA	MASSELLO DI TOULIPIER O FRASSINO SPAZZOLATO SP. CM.3 INTAGLIATO, VERNICIATO O LACCATO A PORO APERTO.
GIROLETTO SUPERIORE	MULTISTRATO SP. CM. 2.5, IMBOTTITO IN GOMMAPIUMA E RIVESTITO DA CAMPIONARIO.
GIROLETTO INFERIORE	MASSELLO DI TOULIPIER O FRASSINO SPAZZOLATO SP.3, VERNICIATO O LACCATO A PORO APERTO.

BED WITH UPHOLSTERED BED SURROUND AND HEADBOARD

HEADBOARD STRUCTURE	SOLID WOOD AND POPLAR MULTILAYER PANEL TH. CM. 2.5 UPHOLSTERED IN FOAM RUBBER AND COVERED WITH OUR RANGE FINISHES.
HEADBOARD MOULDING	TOULIPIER SOLID WOOD OR BRUSHED SOLID ASHWOOD TH. CM.3 CARVED, PAINTED OR OPEN PORE LACQUERED.
TOP BED SURROUND	MULTILAYER TH. CM. 2.5, UPHOLSTERED IN FOAM RUBBER AND COVERED IN OUR RANGE FINISHES.
LOW BED SURROUND	TOULIPIER SOLID WOOD OR BRUSHED SOLID ASHWOOD TH.3, PAINTED OR OPEN PORE LACQUERED.

SIBILLA E SIBILLA LIGHT

RAISSA

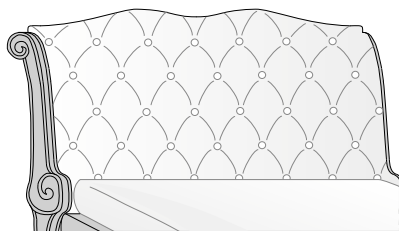

PANNELLO IMBOTTITO CON BOTTONI DECORATIVI
UPHOLSTERED PANEL WITH DECORATION BUTTONS

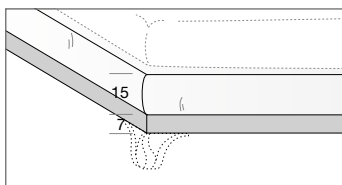

GIROLETTO SUPERIORE IMBOTTITO, GIROLETTO INFERIORE LEGNO
TOP UPHOLSTERED BED, WOODEN LOW BED SURROUND

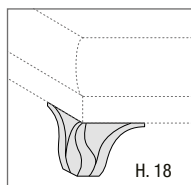

PIEDE LEGNO INTAGLIATO
CARVED WOODEN TOP

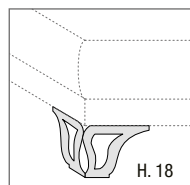

PIEDE METALLO TRAFORATO AL LASER
METAL FOOT PERFORATED WITH LASER

LETTO CON TESTIERA E GIROLETTO IMBOTTITI

STRUTTURA TESTIERA	MASSELLO DI TOULIPIER O FRASSINO SPAZZOLATO E PANNELLO DI MULTISTRATO SP. CM. 2.5 IMBOTTITO IN GOMMAPIUMA E RIVESTITO DA CAMPIONARIO.
GIROLETTO SUPERIORE	MULTISTRATO SP. CM. 2.5, IMBOTTITO IN GOMMAPIUMA E RIVESTITO DA CAMPIONARIO.
GIROLETTO INFERIORE	MASSELLO DI TOULIPIER O FRASSINO SPAZZOLATO SP.3, VERNICIATO O SPAZZOLATO A PORO APERTO.

BED WITH UPHOLSTERED BED SURROUND AND HEADBOARD

HEADBOARD STRUCTURE	TOULIPIER SOLID WOOD OR BRUSHED SOLID ASHWOOD AND MULTILAYER PANEL TH. CM. 2.5 UPHOLSTERED WITH IN FOAM RUBBER AND COVERED WITH OUR RANGE FINISHES.
TOP BED SURROUND	MULTILAYER TH. CM. 2.5, UPHOLSTERED IN FOAM RUBBER AND COVERED IN OUR RANGE FINISHES.
LOW BED SURROUND	TOULIPIER SOLID WOOD OR BRUSHED SOLID ASHWOOD TH.3, OPEN PORE PAINTED OR BRUSHED.

PORTOFINO NOTTE - NIGHT

CARATTERISTICHE TECNICHE TECHNICAL CHARACTERISTICS

COMODINO, SETTIMINO E COMÒ

TOP	PANNELLO DI LISTELLARE IMPIALLACCIATO IN NOCE O FRASSINO SPAZZOLATO SP. CM. 1.5, VERNICIATO O LACCATO A PORO APERTO.
FONDO	PANNELLO DI MULTISTRATO PIOPPO SP. CM. 1.8, VERNICIATO O LACCATO.
FIANCO	PANNELLO SCATOLATO E CURVATO SP. CM. 5, IMPIALLACCIATO ESTERNAMENTE IN NOCE O FRASSINO SPAZZOLATO E INTERNAMENTE IN NOCE TANGANICA, VERNICIATO O LACCATO A PORO APERTO.
SCHIENALE	PANNELLO DI MULTISTRATO SP. CM. 0.8, VERNICIATO O LACCATO.
PIEDE LEGNO	MASSELLO DI TOULIPIER O FRASSINO SPAZZOLATO SP. CM. 4 INTAGLIATO, VERNICIATO O LACCATO A PORO APERTO.
PIEDE METALLO	FINITURA NICHEL LUCIDO.
APERTURE	PUSH-PULL O MANIGLIA

BEDSIDE TABLE, 7-DRAWER CHEST AND CHEST OF DRAWER

TOP	BLOCKBOARD PANEL VENEERED IN WALNUT OR BRUSHED ASHWOOD TH. CM. 1.5, PAINTED OR OPEN PORE LACQUERED.
BOTTOM PANEL	POPLAR MULTILAYER PANEL TH. CM. 1.8, PAINTED OR LACQUERED.
SIDE PANEL	CURVED PANEL TH. CM. 5, VENEERED OUTSIDE IN WALNUT OR BRUSHED ASHWOOD AND INSIDE IN TANGANICA WALNUT, PAINTED OR OPEN PORE LACQUERED.
BACK PANEL	MULTILAYER PANEL TH. CM. 0.8, PAINTED OR LACQUERED.
WOODEN TOP	TOULIPIER SOLID WOOD OR BRUSHED SOLID ASHWOOD TH. CM. 4 CARVED, PAINTED OR OPEN PORE LACQUERED.
METAL FOOT	GLOSSY NICKEL FINISH.
OPENINGS	PUSH-PULL OR HANDLE

COMODINO 2 CASSETTI BEDSIDE TABLE WITH 2 DRAWERS

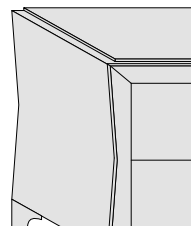

FIANCO SAGOMATO
SHAPE SIDE PANEL

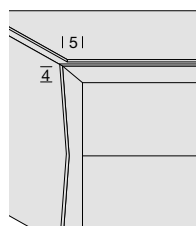

CORNICE COMODINO
FRAME FOR BEDSIDE TABLE

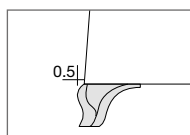

PIEDE LEGNO INTAGLIATO
CARVED WOODEN TOP

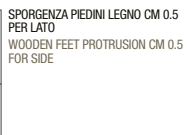

PIEDE METALLO TRAFORATO
AL LASER
METAL FOOT PERFORATED
WITH LASER

SPORGENZA PIEDINI LEGNO CM 0.5
PER LATO
WOODEN FEET PROTRUSION CM 0.5
FOR SIDE

SETTIMINO 6 CASSETTI 6-DRAWER CHEST

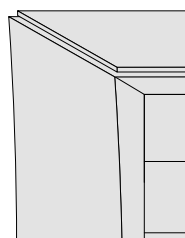

FIANCO SAGOMATO
SHAPE SIDE PANEL

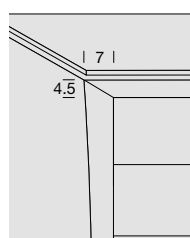

CORNICE SETTIMINO
FRAME FOR 7-DRAWER CHEST

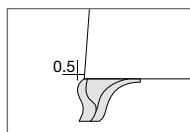

PIEDE LEGNO INTAGLIATO
CARVED WOODEN TOP

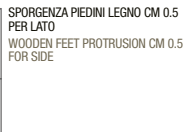

PIEDE METALLO TRAFORATO
AL LASER
METAL FOOT PERFORATED
WITH LASER

SPORGENZA PIEDINI LEGNO CM 0.5
PER LATO
WOODEN FEET PROTRUSION CM 0.5
FOR SIDE

COMÒ 4 CASSETTI CHEST OF DRAWERS WITH 4 DRAWERS

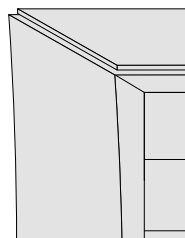

FIANCO SAGOMATO
SHAPE SIDE PANEL

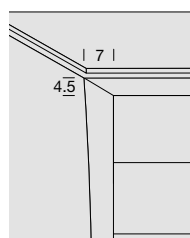

CORNICE SETTIMINO
FRAME FOR 7-DRAWER CHEST

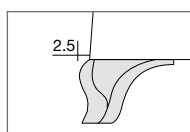

PIEDE LEGNO INTAGLIATO
CARVED WOODEN TOP

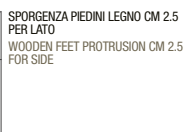

PIEDE METALLO TRAFORATO
AL LASER
METAL FOOT PERFORATED
WITH LASER

SPORGENZA PIEDINI LEGNO CM 2.5
PER LATO
WOODEN FEET PROTRUSION CM 2.5
FOR SIDE

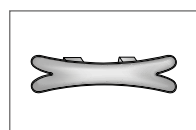

MANIGLIA RABBIT
RABBIT HANDLE

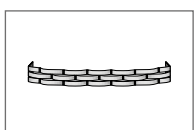

MANIGLIA CINGHIETTA
CINGHIETTA HANDLE

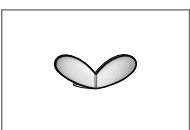

MANIGLIA CUORE
CUORE HANDLE

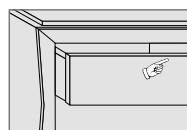

CHIUSURA CASSETTI PUSH-PULL
DRAWERS WITH PUSH-PULL CLOSURE

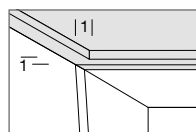

PARTICOLARE TOP RIENTRANTE
DETAIL OF RECESSED TOP

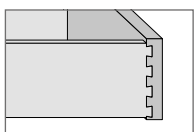

INCASTRI A CODA DI RONDINE
DOVETAIL JOINTS

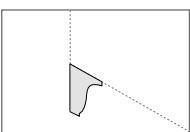

PIEDINO POSTERIORE
BACK FOOT

COMODINO, settimino e comò

FRONTALE CASSETTO	PANNELLO DI LISTELLARE IMPIALLACCIATO IN NOCE O FRASSINO SPAZZOLATO SP. CM. 2.5, E CORNICE PERIMETRALE IN TOULIPIER O FRASSINO SPAZZOLATO SP. CM.3.2, VERNICIATO O LACCATO A PORO APERTO.
STRUTTURA CASSETTO	PANNELLI DI MULTISTRATI BETULLA SP. 1.5, CON INCASTRI A CODA DI RONDINE, VERNICIATO IN FINITURA TINTA ACACIA.
GUIDE CASSETTO	AMMORTIZZATE REGOLABILI IN ALTEZZA.
MANIGLIA	MANIGLIA RABBIT PICCOLA O CUORE IN FINITURA NICHEL LUCIDO, MANIGLIA CINGHIETTA IN NICHEL SATINATO O PUSH-PULL.

BEDSIDE TABLE, 6-DRAWER CHEST, CHEST OF DRAWERS

DRAWER FRONT	BLOCKBOARD PANEL VENEERED IN WALNUT OR BRUSHED ASHWOOD TH. CM. 2.5, AND PERIMETRIC FRAME IN TOULIPIER OR BRUSHED ASHWOOD TH. CM.3.2, PAINTED OR OPEN PORE LACQUERED.
DRAWER STRUCTURE	BIRCH MULTILAYER PANELS TH. 1.5, WITH DOVETAIL JOINTS, PAINTED IN ACACIA STAINED FINISH.
DRAWER GUIDES	HEIGHT ADJUSTABLE SOFT-CLOSE GUIDES
HANDLE	SMALL RABBIT OR CUORE HANDLES IN GLOSSY NICKEL FINISH, CINGHIETTA HANDLE IN SATIN-FINISH NICKEL FINISH OR PUSH-PULL.

CARATTERISTICHE TECNICHE
TECHNICAL CHARACTERISTICS

SPECCHIERA

MIRROR

PORTOFINO

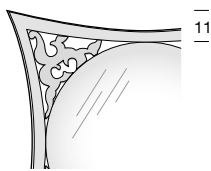

SPECCHIERA

CORNICE TRAFORATA MULTISTRATO IMPIALLACCIATO IN NOCE O FRASSINO SPAZZOLATO SP. CM. 2, VERNICIATO O LACCATO A PORO APERTO.

SUPPORTO POSTERIORE PANNELLO DECORATIVO CM. 1.8.

SPECCHIO ARGENTO

MIRROR

PERFORATED FRAME MULTILAYER VENEERED IN WALNUT OR BRUSHED ASHWOOD TH. CM. 2, PAINTED OR OPEN PORE LACQUERED.

BACK SUPPORT DECORATIVE PANEL CM. 1.8.

MIRROR SILVER

TOILETTE

STRUTTURA MASSELLO DI TOULIPIER O FRASSINO SPAZZOLATO, VERNICIATO O LACCATO A PORO APERTO.
GAMBA LEGNO MASSELLO DI TIGLIO O FRASSINO SPAZZOLATO SP. CM. 11, VERNICIATO O LACCATO A PORO APERTO.

DRESSING TABLE

STRUCTURE TOULIPIER SOLID WOOD OR BRUSHED SOLID ASHWOOD, PAINTED OR OPEN PORE LACQUERED.
WOODEN LEG LINDEN SOLID WOOD OR BRUSHED SOLID ASHWOOD TH. CM. 11, PAINTED OR OPEN PORE LACQUERED.

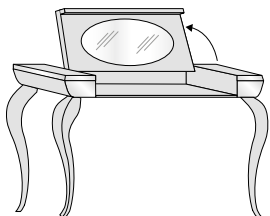

TOILETTE

PIANO LISTELLARE IMPIALLACCIATO IN NOCE O FRASSINO SPAZZOLATO SP. CM.1.8 E SPONDE IN MASSELLO DI TOULIPIER O FRASSINO SPAZZOLATO SP. CM.3.4, VERNICIATO O LACCATO A PORO APERTO.

DRESSING TABLE

TOP BLOCKBOARD VENEERED IN WALNUT OR BRUSHED ASHWOOD TH. CM.1.8 AND SIDES IN TOULIPIER SOLID WOOD OR BRUSHED SOLID ASHWOOD TH. CM.3.4, PAINTED OR OPEN PORE LACQUERED.

PORTOFINO NOTTE - NIGHT

CARATTERISTICHE TECNICHE TECHNICAL CHARACTERISTICS

ARMADIO ANTE SCORREVOLI

CAPPELLO, FONDO E FIANCO DIVISORIO	PANNELLO DI PARTICELLE DI LEGNO RIVESTITO SU 2 LATI IN DECORATIVO OLMO SBIANCATO SP. 2,5 CM
FIANCO	PANNELLO IN LEGNO CON TELAIO IN ABETE SP. CM. 3 IMPIALLACCIATO ESTERNAMENTE IN FRASSINO SPAZZOLATO ED INTERNAMENTE IN DECORATIVO.
RIPIANO	PANNELLO DI PARTICELLE DI LEGNO RIVESTITO SU 2 LATI IN DECORATIVO OLMO SBIANCATO SP. 2,5 CM E BORDO FRONTALE SP. 3,6 CM
SCHIENALE	PANNELLO DI MDF IMPIALLACCIATO IN DECORATIVO SP. CM.0.8.

WARDROBE WITH SLIDING DOORS

TOP, BOTTOM AND PARTITION SIDE PANEL	PANEL OF WOOD PARTICLES COVERED ON 2 SIDES IN DECORATIVE BLEACHED ELM TH. 2.5 CM
SIDE PANEL	WOOD PANEL WITH FIR FRAME TH. CM. 3 VENEERED OUTSIDE IN BRUSHED ASHWOOD AND INSIDE IN DECORATIVE.
SHELF	PANEL OF WOOD PARTICLES COVERED ON 2 SIDES IN DECORATIVE 'OLMO SBIANCATO' TH. 2,5 CM AND FRONT EDGE TH. 3.6 CM
BACK PANEL	DECORATIVE VENEERED MDF PANEL TH. CM.0.8.

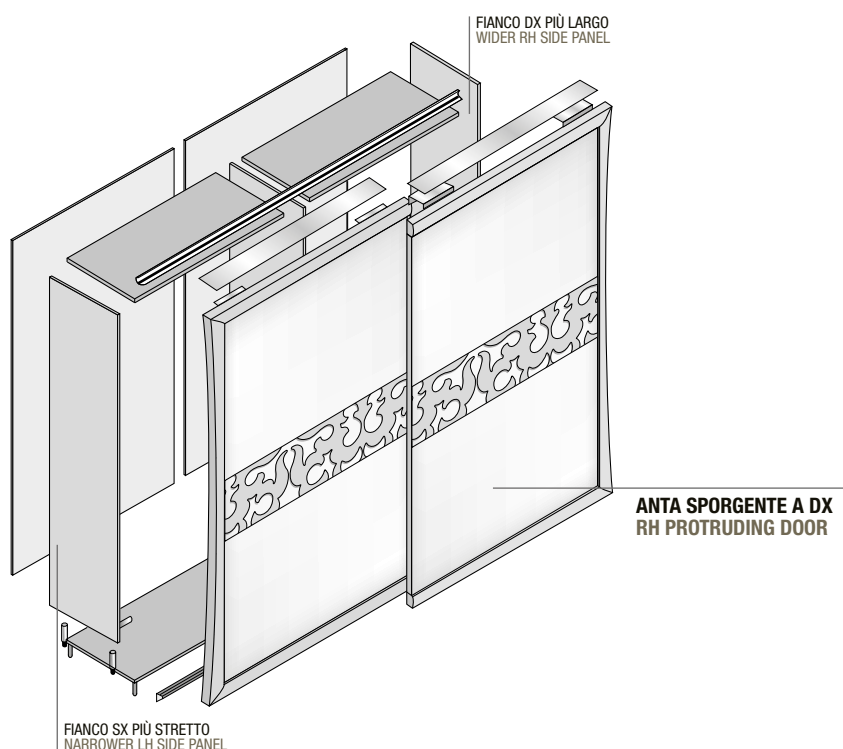

ANTE SCORREVOLI (VERSIONE 2 O 3 ANTE)

ANTE	TELAIO IN MASSELLO DI TOULIPIER O FRASSINO SPAZZOLATO SP. CM. 3.4 E PANNELLO TRAFORATO IN MULTISTRATO IMPIALLACCIATO IN NOCE O FRASSINO SPAZZOLATO SP. CM. 2, VERNICIATO O LACCATO A PORO APERTO.
VETRO O SPECCHIO	SERIGRAFATO SP. CM. 0.4 CON DISEGNO "MILLERIGHE" O SPECCHIO ARGENTO O BRONZO APPLICATO SU PANNELLO IN MULTISTRATO SP. CM. 1.5.
CASSETTIERA INTERNA EASY (OPTIONAL)	TOP IN PANNELLO IN LEGNO SP. CM 4 CON FONDO, FIANCHI E FRONTALI CASSETTO IN PANNELLO DI MULTISTRATO TRUCIOLARE SP. CM. 1.5 CON GUIDE CASSETTO IN LEGNO.

LAMPADA LED L.100 CON SENSORE (OPTIONAL).

SLIDING DOORS (VERSION WITH 2 OR 3 DOORS)

DOORS	FRAME IN TOULIPIER SOLID WOOD OR BRUSHED SOLID ASHWOOD TH. CM. 3.4 AND MULTILAYER PERFORATED PANEL VENEERED IN WALNUT OR BRUSHED ASHWOOD TH. CM. 2, PAINTED OR OPEN PORE LACQUERED.
GLASS OR MIRROR	SCREEN-PRINTED TH. CM. 0.4 WITH "MILLERIGHE" OR SILVER/BRONZE MIRROR DRAWING APPLIED ON MULTILAYER PANEL TH. CM. 1.5.
INTERNAL EASY DRAWER UNIT (OPTIONAL)	WITH WOOD PANEL TOP TH. CM 4 WITH DRAWER BOTTOM, SIDE AND FRONTS IN MULTILAYER PANEL TH. CM. 1.5 WITH WOODEN DRAWER GUIDES.

LED LAMP W.100 WITH SENSOR (OPTIONAL).

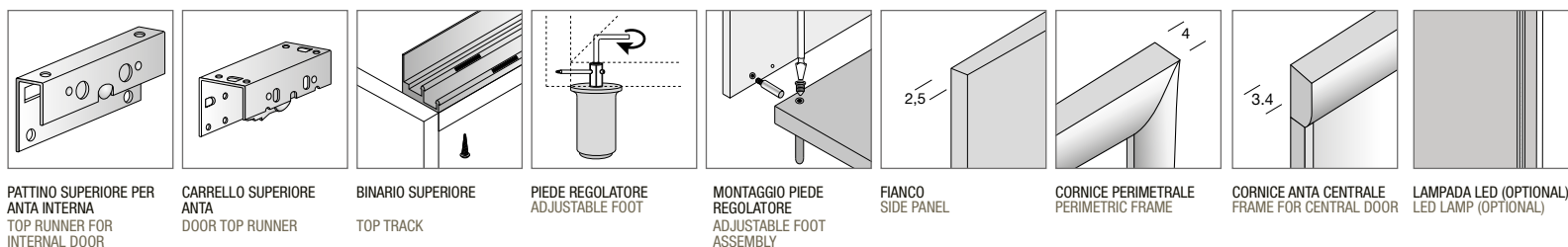

VANI INTERNI INTERNAL COMPARTMENT

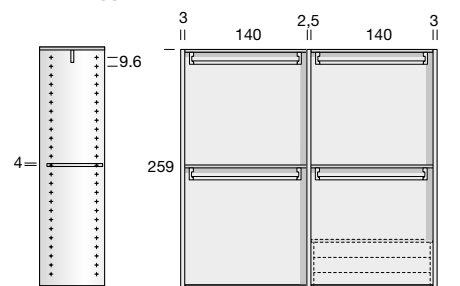

2 ANTE SCORREVOLI 2 SLIDING DOORS

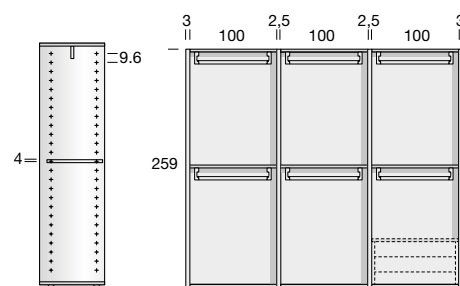

3 ANTE SCORREVOLI 3 SLIDING DOORS

REGOLAZIONE ANTE PRIMA DEL MONTAGGIO DOOR ADJUSTMENT BEFORE ASSEMBLY

PRIMA DI PROCEDERE AL MONTAGGIO, BISOGNA REGOLARE LA TENSIONE DELLE ANTE POSIZIONANDOLE OBBLIGATORIAMENTE IN ORIZZONTALE E UTILIZZANDO UN CACCIAVITE O UN PUNTERUOLO.
BEFORE ASSEMBLING REGULATE DOOR TENSION BY PLACING THEM HORIZONTALLY AND USING THE SPECIAL SPANNER PROVIDED.

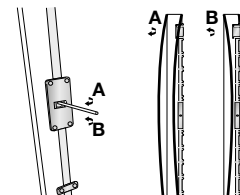

MONTAGGIO ANTE SCORREVOLI SLIDING DOOR ASSEMBLY

PER POTER AGGANCIARE LE ANTE AL BINARIO SUPERIORE TRA IL SOFFITTO E L'ARMADIO CI DEVONO ESSERE ALMENO 3 CM.
LEAVE AT LEAST 3CM CLEARANCE SO THAT THE DOORS CAN BE ATTACHED TO THE UPPER RAIL BETWEEN THE CEILING AND WARDROBE.

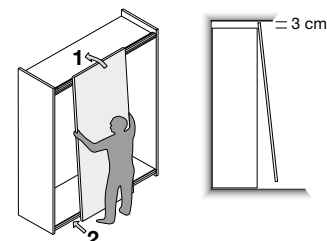

- 1 AGGANCIARE L'ANTA AL BINARIO SUPERIORE
FASTEN THE DOOR TO THE TOP TRACK
- 2 SPINGERE L'ANTA NEL BINARIO INFERIORE
PUSH THE DOOR IN THE LOW TRACK

SMONTAGGIO ANTE SCORREVOLI REMOVAL SLIDING DOORS

PER SBLOCCARE LE ANTE DAL SISTEMA DI BLOCCAGGIO DI SICUREZZA È NECESSARIO AVVITARE IL GRANO (1), LA LINGUETTA (2) SI SPOSTA AUTOMATICAMENTE E SARÀ POSSIBILE SGANCIARE LE ANTE.
TO RELEASE THE DOORS FROM THE SAFETY LOCKING SYSTEM YOU NEED TO TIGHTEN THE SPECIAL SCREW(1), THE TAB (2) AUTOMATICALLY MOVES AND THE DOORS CAN BE RELEASED

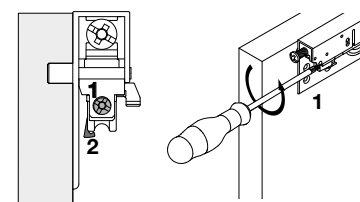

CARATTERISTICHE TECNICHE TECHNICAL CHARACTERISTICS

ARMADIO ANTE BATTENTI

CAPPELLO E FONDO	PANNELLO IN LEGNO CON TELAIO IN ABETE IMPIALLACCIATO IN FRASSINO SP. CM. 2.5, VERNICIATO TINTO ACACIA.
FIANCO	PANNELLO IN LEGNO CON TELAIO IN ABETE SP. CM. 3 IMPIALLACCIATO ESTERNAMENTE IN NOCE TANGANICA O FRASSINO SPAZZOLATO ED INTERNAMENTE IN FRASSINO VERNICIATO TINTA ACACIA.
FIANCO DIVISORIO	PANNELLO IN LEGNO CON TELAIO IN ABETE IMPIALLACCIATO IN FRASSINO AMBO I LATI DI SP. CM. 3 IN VERNICIATO TINTA ACACIA.
RIPIANO	PANNELLO IN LEGNO CON TELAIO IN ABETE IMPIALLACCIATO IN FRASSINO SP. CM. 4 IN VERNICIATO TINTA ACACIA.
SCHIENALE	PANNELLO DI MULTISTRATO IMPIALLACCIATO IN FRASSINO SP. CM. 0.8 IN VERNICIATO TINTA ACACIA.
VERSIONI	4 ANTE BATTENTE E 3 ANTE BATTENTE PICCOLO. CERNIERE AMMORTIZZATE DI SERIE.

WARDROBE WITH HINGED DOORS

TOP AND BOTTOM PANEL	WOOD PANEL WITH FIR FRAME VENEERED IN ASHWOOD TH. CM. 2.5, ACACIA STAINED FINISH.
SIDE PANEL	WOOD PANEL WITH FIR FRAME TH. CM. 3 VENEERED OUTSIDE IN TANGANICA WALNUT OR BRUSHED ASHWOOD AND INSIDE IN ASHWOOD IN ACACIA STAINED PAINTED.
PARTITION SIDE PANEL	WOOD PANEL WITH FIR FRAME VENEERED IN ASHWOOD ON BOTH SIDES TH. CM. 3 IN ACACIA STAINED FINISH.
SHELF	WOOD PANEL WITH FIR FRAME VENEERED IN ASHWOOD TH. CM. 4 IN ACACIA STAINED PAINTED.
BACK PANEL	MULTILAYER PANEL VENEERED IN ASHWOOD TH. CM. 0.8 IN ACACIA STAINED PAINTED.
VERSIONS	4 HINGED DOORS AND 3 PICCOLO HINGED DOORS. STANDARD SOFT-CLOSE HINGES.

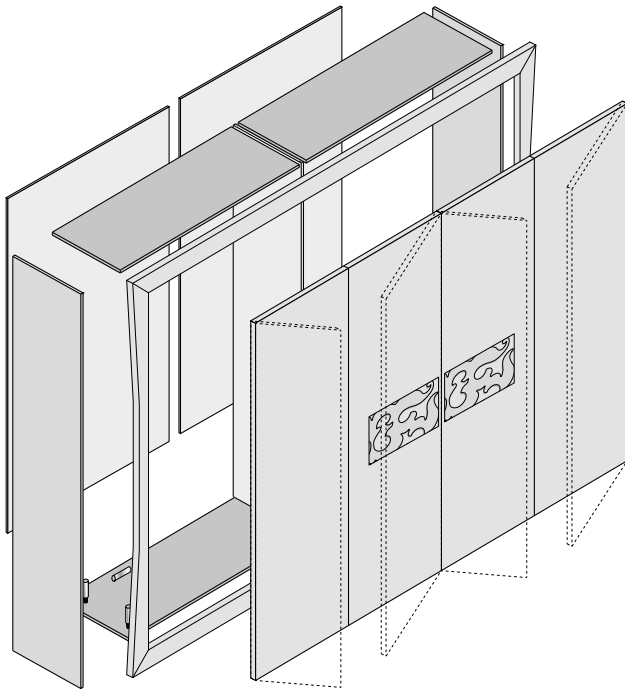

ANTE BATTENTI (VERSIONE 3 O 4 ANTE)

CORNICE PERIMETRALE	MASSELLO DI TOULIPIER O FRASSINO SPAZZOLATO SP. CM. 4.
ANTE	TELAIO IN LEGNO CON PANNELLO DI ABETE IMPIALLACCIATO IN NOCE O FRASSINO SPAZZOLATO AMBO I LATI SP. CM. 2.5, VERNICIATO O SPAZZOLATO A PORO APERTO.
MANIGLIA	RABBIT GRANDE IN ZAMA NICHEL LUCIDO CM. 16 (1 MANIGLIA PER COPPIA DI ANTE), MANIGLIA CUORE IN ZAMA NICHEL LUCIDO CM. 10 (2 MANIGLIE PER COPPIA DI ANTE) O MANIGLIA CINGHIETTA NICHEL SATINATO.
CASSETTIERA INTERNA (OPTIONAL)	TOP IN PANNELLO IN LEGNO SP. CM. 4, FONDO, FIANCHI E FRONTALI CASSETTO IN PANNELLO DI MULTISTRATO BETULLA SP. CM. 1.5, IN FINITURA TINTA ACACIA CON GUIDE CASSETTO AMMORTIZZATE.
CASSETTIERA INTERNA EASY (OPTIONAL)	TOP IN PANNELLO DI PARTICELLE DI LEGNO SP. CM 4 CON FONDO, FIANCHI E FRONTALI CASSETTO IN PANNELLO DI MULTISTRATO BETULLA SP. CM. 1.5 IN FINITURA TINTA ACACIA CON GUIDE CASSETTO IN LEGNO.

LAMPADA LED L.100 CON SENSORE (OPTIONAL).

HINGED DOORS (VERSION WITH 3 OR 4 DOORS)

PERIMETRIC FRAME DOORS	TOULIPIER SOLID WOOD OR BRUSHED SOLID ASHWOOD TH. CM. 4. WOOD FRAME WITH FIR PANEL VENEERED IN WALNUT OR BRUSHED ASHWOOD ON BOTH SIDES TH. CM. 2.5, OPEN PORE BRUSHED OR PAINTED.
HANDLE	LARGE RABBIT IN GLOSSY NICKEL ZAMAK CM. 16 (1 HANDLE PER PAIR OF DOORS), CUORE HANDLE IN GLOSSY NICKEL ZAMAK CM. 10 (2 HANDLES PER PAIR OF DOORS) OR CINGHIETTA HANDLE INSATIN-FINISH NICKEL.
INTERNAL DRAWER UNIT (OPTIONAL)	TOP IN WOOD PANEL TH. CM. 4, DRAWER BOTTOM, SIDE PANELS AND FRONTS IN BIRCH MULTILAYER PANEL TH. CM. 1.5, IN ACACIA STAINED FINISH WITH SOFT-CLOSE DRAWER GUIDES.
INTERNAL EASY DRAWER UNIT (OPTIONAL)	WOOD PARTICLE BOARD PANEL TOP TH. CM 4 WITH DRAWER BOTTOM, DRAWER SIDES AND FRONTS IN BIRCH MULTILAYER PANEL TH. CM. 1.5 IN ACACIA STAINED FINISH WITH WOODEN DRAWER GUIDES.

LED LAMP W.100 WITH SENSOR (OPTIONAL).

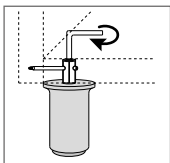

PIEDE REGOLATORE
ADJUSTABLE FOOT

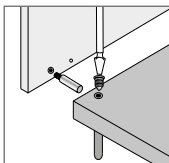

MONTAGGIO PIEDE
REGOLATORE
ADJUSTABLE FOOT
ASSEMBLY

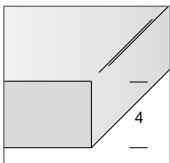

RIPIANO INTERNO
INTERNAL SHELF

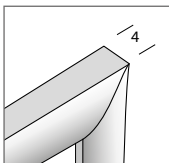

CORNICE PERIMETRALE
PERIMETRIC FRAME

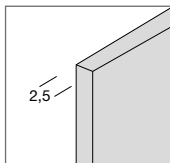

FIANCO
SIDE PANEL

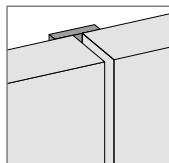

BATTUTA ANTE LEGNO
WOODEN DOOR PROFILE

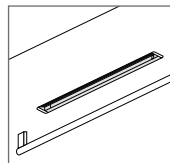

LAMPADA LED (OPTIONAL)
LED LAMP (OPTIONAL)

VANI INTERNI

INTERNAL COMPARTMENT

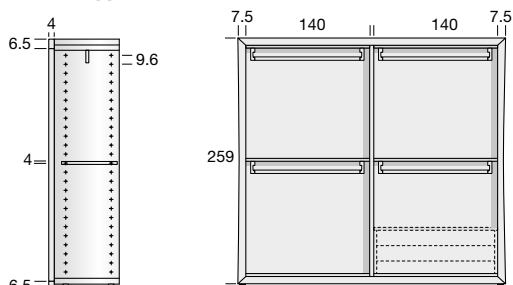

4 ANTE BATTENTE 4 HINGED DOORS

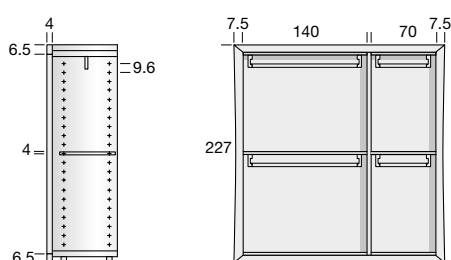

3 ANTE BATTENTE 3 HINGED DOORS

INGOMBRO ANTE APERTE ARMADI BATTENTI

DIMENSIONS OF WARDROBE OPEN HINGED DOORS

NEGLI ARMADI BATTENTI L'INGOMBRO TOTALE È CALCOLATO SOMMANDO LA PROFONDITÀ DELL'ARMADIO E LA LARGHEZZA DELL'ANTA NEL VANO L.140 COMPRESIVA DELLO SPESSORE DELLA CORNICE

TOTAL DIMENSIONS OF WARDROBES WITH HINGED DOORS ARE CALCULATED BY ADDING THE WARDROBE DEPTH AND WIDTH OF THE DOOR FOR THE W.140 COMPARTMENT, INCLUDING THE TRIM THICKNESS.

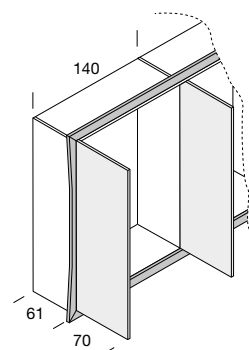

MANIGLIA

HANDLE

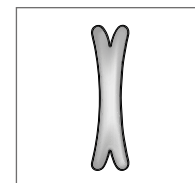

MANIGLIA RABBIT GRANDE
RABBIT LARGE HANDLE

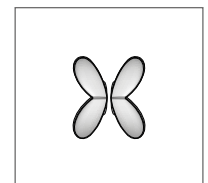

MANIGLIA CUORE
CUORE HANDLE

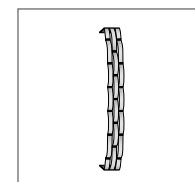

MANIGLIA CINGHIETTA
CINGHIETTA HANDLE

CREDENZE E VETRINE

RIPIANI	VETRO FILO LUCIDO SP. CM. 0.8.
PIEDE LEGNO	MASSELLO DI TOULIPIER O FRASSINO SPAZZOLATO SP. CM. 4 INTAGLIATO, VERNICIATO O LACCATO A PORO APERTO.
PIEDE METALLO	FINITURA NICHEL LUCIDO.
VERSIONI	CREDENZA ANTE BATTENTI: 2 ANTE, 3 ANTE, 2 ANTE E 4 CASSETTI

SIDEBOARDS AND DISPLAY UNITS

SHELVES	FLUSH GLOSSY GLASS TH. CM. 0.8.
WOODEN TOP	TOULIPIER SOLID WOOD OR BRUSHED SOLID ASHWOOD TH. CM. 4 CARVED, PAINTED OR OPEN PORE LACQUERED.
METAL FOOT	GLOSSY NICKEL FINISH.
VERSIONS	SIDEBOARD WITH HINGED DOORS: 2 DOORS, 3 DOORS, 2 DOORS AND 4 DRAWERS

CREDENZA ANTE BATTENTI SIDEBOARD WITH HINGED DOORS

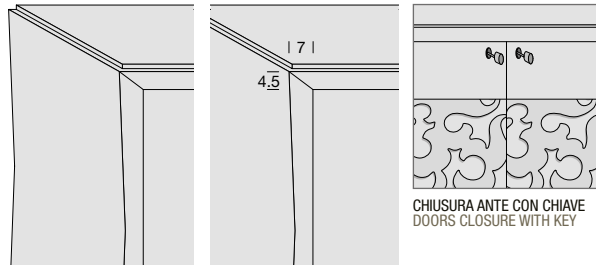

FIANCO SAGOMATO
SHAPED SIDE PANEL

CORNICE CREDENZA
FRAME FOR SIDEBOARD

CHIUSURA ANTE CON CHIAVE
DOORS CLOSURE WITH KEY

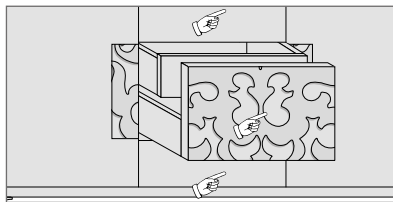

CHIUSURA CASSETTI PUSH-PULL
DRAWERS WITH PUSH-PULL CLOSURE

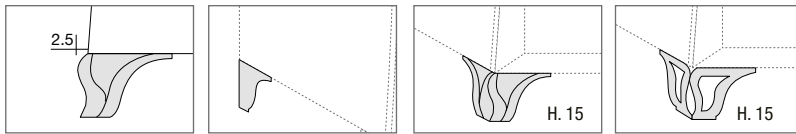

SPORGENZA PIEDINI LEGNO CM 2.5 PER LATO
WOODEN FEET PROTRUSION CM 2.5 FOR SIDE

PIEDINO POSTERIORE
BACK FOOT

PIEDE LEGNO INTAGLIATO
CARVED WOODEN TOP

PIEDE METALLO TRAFORATO AL LASER
METAL FOOT PERFORATED WITH LASER

CREDENZA 2 E 3 ANTE BATTENTI

TOP	PANNELLO DI LISTELLARE IMPIALLACCIATO IN NOCE O FRASSINO SPAZZOLATO SP. CM. 1.5, VERNICIATO O LACCATO A PORO APERTO.
FONDO	PANNELLO DI MULTISTRATO PIOPPO SP. CM. 1.8, VERNICIATO O LACCATO.
FIANCO	PANNELLO SCATOLATO E CURVATO SP. CM. 7.5, IMPIALLACCIATO ESTERNAMENTE NOCE O FRASSINO SPAZZOLATO ED INTERNAMENTE IN NOCE TANGANIKA, VERNICIATO O LACCATO A PORO APERTO.
SCHIENALE	PANNELLO DI MULTISTRATO SP. CM. 0.8, VERNICIATO O LACCATO.
ANTA	PANNELLO LISTELLARE SP. CM. 2.5 IMPIALLACCIATO NOCE O FRASSINO SPAZZOLATO E PANNELLO TRAFORATO MULTISTRATI IMPIALLACCIATO NOCE O FRASSINO S.P. CM. 0.8, VERNICIATO O LACCATO A PORO APERTO.
STRUTTURA CASSETTO	PANNELLO DI MULTISTRATO BETULLA SP. CM. 1.5, CON INCASTRI A CODA DI RONDINE, FINITURA TINTA ACACIA.
APERTURA	CHIAVE DI SERIE IN FINITURA NICHEL LUCIDO. PUSH-PULL PER I CASSETTI.

SIDEBOARD WITH HINGED DOORS

TOP	BLOCKBOARD PANEL VENEERED IN WALNUT OR BRUSHED ASHWOOD TH. CM. 1.5, PAINTED OR OPEN PORE LACQUERED.
BOTTOM PANEL	POPLAR MULTILAYER PANEL TH. CM. 1.8, PAINTED OR LACQUERED.
SIDE PANEL	CURVED PANEL TH. CM. 7.5, VENEERED OUTSIDE IN WALNUT OR BRUSHED ASHWOOD AND INSIDE IN TANGANIKA WALNUT, PAINTED OR OPEN PORE LACQUERED.
BACK PANEL	MULTILAYER PANEL TH. CM. 0.8, PAINTED OR LACQUERED.
DOOR	BLOCKBOARD PANEL TH. CM. 2.5 VENEERED IN WALNUT OR BRUSHED ASHWOOD AND MULTILAYER PERFORATED PANEL VENEERED IN WALNUT OR ASHWOOD TH. CM. 0.8, PAINTED OR OPEN PORE LACQUERED.
DRAWER STRUCTURE	BIRCH MULTILAYER PANEL TH. CM. 1.5, WITH DOVETAIL JOINTS, ACACIA STAINED FINISH.
OPENING	STANDARD KEY IN GLOSSY NICKEL FINISH. PUSH-PULL FOR DRAWERS.

VETRINA DISPLAY UNIT

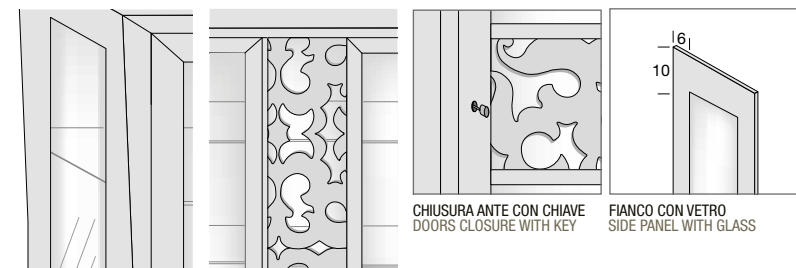

FIANCO SAGOMATO
SHAPED SIDE PANEL

PANNELLO CON TRAFORO LEGNO
PANEL WITH WOODEN DECORATION

CHIUSURA ANTE CON CHIAVE
DOORS CLOSURE WITH KEY

FIANCO CON VETRO
SIDE PANEL WITH GLASS

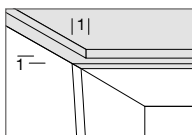

PARTICOLARE TOP RIENTRANTE
DETAIL OF RECESSED TOP

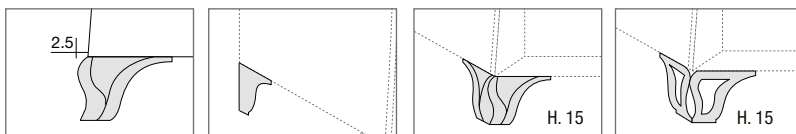

SPORGENZA PIEDINI LEGNO CM 2.5 PER LATO
WOODEN FEET PROTRUSION CM 2.5 FOR SIDE

PIEDINO POSTERIORE
BACK FOOT

PIEDE LEGNO INTAGLIATO
CARVED WOODEN TOP

PIEDE METALLO TRAFORATO AL LASER
METAL FOOT PERFORATED WITH LASER

VETRINA 1 E 2 ANTE

CAPPELLO	PANNELLO DI LISTELLARE IMPIALLACCIATO NOCE TANGANIKA O FRASSINO SPAZZOLATO SP. CM. 1.8.
TELAIO	FRONTALE VETRINA IN MASSELLO DI TOULIPIER O FRASSINO SPAZZOLATO SP. CM. 3.2, VERNICIATO O LACCATO A PORO APERTO.
FONDO	PANNELLO DI LISTELLARE IMPIALLACCIATO NOCE TANGANIKA O FRASSINO SPAZZOLATO SP. CM. 1.8.
FIANCO	TELAIO IN MASSELLO DI TOULIPIER O FRASSINO SPAZZOLATO SAGOMATO SP. CM. 4 CON VETRO FLOAT SP. CM. 0.4, VERNICIATO O LACCATO A PORO APERTO.
SCHIENALE	PANNELLO DI MULTISTRATO IMPIALLACCIATO NOCE TANGANIKA O FRASSINO SPAZZOLATO SP. CM. 0.8, CON PROFILO SUPPORTO RIPIANI IN MASSELLO DI TOULIPIER SP. CM. 6, VERNICIATO O LACCATO A PORO APERTO.
ANTA	IN MASSELLO DI TOULIPIER O FRASSINO SPAZZOLATO SP. CM. 2.7 E PANNELLO TRAFORATO DI MULTISTRATO IMPIALLACCIATO IN NOCE O FRASSINO SPAZZOLATO SP. CM. 2, VETRO FLOAT SP. CM. 0.4.
APERTURA	CHIAVE DI SERIE IN FINITURA NICHEL LUCIDO.

DISPLAY UNIT

TOP	BLOCKBOARD PANEL VENEERED IN TANGANIKA WALNUT OR BRUSHED ASHWOOD TH. CM. 1.8.
FRAME	DISPLAY UNIT FRONT IN TOULIPIER SOLID WOOD OR BRUSHED SOLID ASHWOOD TH. CM. 3.2, PAINTED OR OPEN PORE LACQUERED.
BOTTOM PANEL	BLOCKBOARD PANEL VENEERED IN TANGANIKA WALNUT OR BRUSHED ASHWOOD TH. CM. 1.8.
SIDE PANEL	FRAME IN TOULIPIER SOLID WOOD OR BRUSHED SOLID ASHWOOD, SHAPED TH. CM. 4 WITH FLOAT GLASS TH. CM. 0.4, PAINTED OR OPEN PORE LACQUERED.
BACK PANEL	MULTILAYER PANEL VENEERED IN TANGANIKA WALNUT OR BRUSHED ASHWOOD TH. CM. 0.8, WITH SHELF SUPPORT PROFILE IN TOULIPIER SOLID WOOD TH. CM. PAINTED OR OPEN PORE LACQUERED.
DOOR	IN TOULIPIER SOLID WOOD OR BRUSHED SOLID ASHWOOD TH. CM. 2.7 AND MULTILAYER PERFORATED PANEL VENEERED IN WALNUT OR BRUSHED ASHWOOD TH. CM. 2, FLOAT GLASS TH. CM. 0.4.
OPENING	STANDARD KEY IN GLOSSY NICKEL FINISH.

CARATTERISTICHE TECNICHE
TECHNICAL CHARACTERISTICS

TAVOLI, TAVOLINI E CONSOLLE
TABLES, SMALL TABLES AND CONSOLLE

PORTOFINO

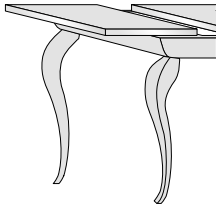

TAVOLO ALLUNGABILE:
IL PIANO SCORRE LATERALMENTE
PER POTER INSERIRE L'ALLUNGA
EXTENDING TABLE
THE TOP SLIDES SIDEWAYS TO
ACCOMMODATE THE EXTENSION.

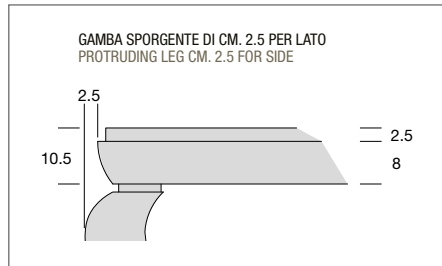

PROFILO TAVOLO
TABLE PROFILE

TAVOLO RETTANGOLARE E QUADRATO ALLUNGABILE

- PIANO LEGNO** PANNELLO DI PARTICELLE DI LEGNO IMPIALLACCIATO IN NOCE O FRASSINO SPAZZOLATO SP. CM. 2.6 E STRUTTURA PERIMETRALE IN MASSELLO DI TOULIPIER O FRASSINO SPAZZOLATO SP. CM. 3.4 VERNICIATO O LACCATO A PORO APERTO.
- ALLUNGA** PANNELLO DI PARTICELLE DI LEGNO IMPIALLACCIATO IN NOCE O FRASSINO SPAZZOLATO SP. CM. 2.6, 1 ALLUNGA INTERNA LATERALE.
- STRUTTURA** MASSELLO DI TOULIPIER O FRASSINO SPAZZOLATO, VERNICIATO O LACCATO A PORO APERTO.
- GAMBA LEGNO** MASSELLO DI TIGLIO O FRASSINO SPAZZOLATO SP. CM. 11, VERNICIATO O LACCATO A PORO APERTO.

RECTANGULAR AND SQUARE EXTENDING TABLE

- WOODEN TOP** WOOD PARTICLE BOARD PANEL VENEERED IN WALNUT OR BRUSHED ASHWOOD TH. CM. 2.6 AND PERIMETRIC STRUCTURE IN TOULIPIER SOLID WOOD OR BRUSHED SOLID ASHWOOD TH. CM. 3.4 PAINTED OR OPEN PORE LACQUERED.
- EXTENSION** WOOD PARTICLE BOARD PANEL VENEERED IN WALNUT OR BRUSHED ASHWOOD TH. CM. 2.6, 1 SIDE INTERNAL EXTENSION
- STRUCTURE** TOULIPIER SOLID WOOD OR BRUSHED SOLID ASHWOOD, PAINTED OR OPEN PORE LACQUERED.
- WOODEN LEG** LINDEN SOLID WOOD OR BRUSHED SOLID ASHWOOD TH. CM. 11, PAINTED OR OPEN PORE LACQUERED.

PORTOFINO

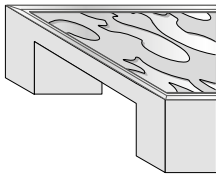

TRAFORO IN LEGNO E TOP IN VETRO
INCASSATO NELLA STRUTTURA
PERFORATED IN WOOD AND GLASS TOP
BUILT IN THE STRUCTURE

TAVOLINO QUADRATO E RETTANGOLARE

- PIANO TRAFORATO** PANNELLO IN MULTISTRATI DI NOCE O FRASSINO SPAZZOLATO SP. CM. 0.8, VERNICIATO O LACCATO A PORO APERTO, TOP IN VETRO TRASPARENTE SP. CM. 0.6.
- STRUTTURA** MASSELLO TOULIPIER O FRASSINO SPAZZOLATO SP. CM. 2.6, VERNICIATO O LACCATO A PORO APERTO.
- TOP** VETRO SP. 0.6 CM

RECTANGULAR AND SQUARE TABLE

- PERFORATED TOP** MULTILAYER PANEL IN WALNUT OR BRUSHED ASHWOOD TH. CM. 0.8, PAINTED OR OPEN PORE LACQUERED, TRANSPARENT GLASS TOP TH. CM. 0.6.
- STRUCTURE** TOULIPIER SOLID WOOD OR SOLID ASHWOOD TH. CM. 2.6, PAINTED OR OPEN PORE LACQUERED.
- TOP** GLASS TH. 0.6 CM

PORTOFINO

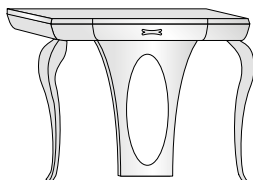

CONSOLLE 1 CASSETTO

- PIANO** PANNELLO DI LISTELLARE IMPIALLACCIATO IN NOCE O FRASSINO SPAZZOLATO SP. CM. 1.8 E SPONDE IN MASSELLO DI TOULIPIER O FRASSINO SPAZZOLATO SP. CM. 3.4, VERNICIATO O LACCATO A PORO APERTO.
- GAMBA POSTERIORE** PANNELLO DI LISTELLARE IMPIALLACCIATO NOCE O FRASSINO SPAZZOLATO SP. CM. 3, VERNICIATO O LACCATO A PORO APERTO.
- STRUTTURA CASSETTO** PANNELLO DI MULTISTRATO BETULLA SP. CM. 1.5, VERNICIATO TINTO ACACIA.

CONSOLE WITH 1 DRAWER

- TOP** BLOCKBOARD VENEERED PANEL IN WALNUT OR BRUSHED ASHWOOD TH. CM. 1.8 AND SIDES IN TOULIPIER SOLID WOOD OR BRUSHED ASHWOOD TH. CM. 3.4, PAINTED OR OPEN PORE LACQUERED.
- BACK LEG** VENEERED PANEL WALNUT OR BRUSHED ASHWOOD TH. CM. 3, PAINTED OR OPEN PORE LACQUERED.
- DRAWER STRUCTURE** BIRCH MULTILAYER PANEL TH. CM. 1.5, ACACIA STAINED PAINTED.

SEDIE

FUSTO MASSELLO DI FAGGIO, VERNICIATO O LACCATO.

CHAIRS

CARCASE LACQUERED OR PAINTED BEECH SOLID WOOD.

PENELOPE

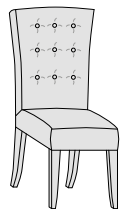

SEDIA

IMBOTTITURA GOMMAPIUMA CON BOTTONI E RIVESTIMENTO CON TESSUTI DA CAMPIONARIO.

CHAIR

PADDING FOAM RUBBER WITH BOTTONS AND COVER WITH SAMPLE FABRICS.

COCÒ

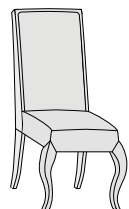

SEDIA

IMBOTTITURA GOMMAPIUMA E RIVESTIMENTO CON TESSUTI DA CAMPIONARIO.

CHAIR

PADDING FOAM RUBBER AND COVER WITH SAMPLE FABRICS.

LETTO PORTOFINO PANNELLO TRAFORATO PORTOFINO BED PERFORATED PANEL

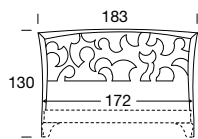

NOCE-FRASSINO / WALNUT-ASHWOOD

LETTO DA 160 - (CONTENITORE CON RETE BASCULANTE OPTIONAL)
160 CM WIDE BED - (OPTIONAL BED STORAGE WITH TILTING BED BASE)



MISURE INTERNE 162X202 PER MATERASSO 160X200
INTERNAL DIMENSIONS 162X202 FOR MATTRESS 160X200

PFN5001K	OPTIONAL	
3.375	PIEDI NICHEL NICKEL FEET	BOX CONTENITORE STORAGE BED
mc 0,55 - Kg 60	+ 211	+ 680 mc 0,40 - Kg 66

LETTO FRIDA PANNELLO TESTIERA IMBOTTITO FRIDA BED UPHOLSTERED HEADBOARD PANEL

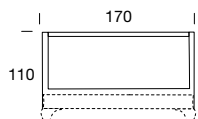

NOCE-FRASSINO / WALNUT-ASHWOOD

LETTO DA 160 - (CONTENITORE CON RETE BASCULANTE OPTIONAL)
160 CM WIDE BED - (OPTIONAL BED STORAGE WITH TILTING BED BASE)



MISURE INTERNE 162X202 PER MATERASSO 160X200
INTERNAL DIMENSIONS 162X202 FOR MATTRESS 160X200

PFN5601K			OPTIONAL	
CAT. A	CAT. B	CAT. C	PIEDI NICHEL NICKEL FEET	BOX CONTENITORE STORAGE BED
ECOPELLE/ECONABUK ECOLEATHER/ECONABUK	LINO/VELLUTO LINEN/VELVET	PELLE LEATHER		
3.869	4.233	4.572	+ 211	+ 680
mc 0,55 - Kg 60			mc 0,40 - Kg 66	

LETTO TEODORA PANNELLO TESTIERA IMBOTTITO TEODORA BED UPHOLSTERED HEADBOARD PANEL

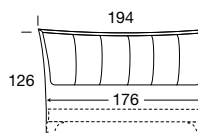

NOCE-FRASSINO / WALNUT-ASHWOOD

LETTO DA 160 - (CONTENITORE CON RETE BASCULANTE OPTIONAL)
160 CM WIDE BED - (OPTIONAL BED STORAGE WITH TILTING BED BASE)



MISURE INTERNE 162X202 PER MATERASSO 160X200
INTERNAL DIMENSIONS 162X202 FOR MATTRESS 160X200

PFN5441K			OPTIONAL	
CAT. A	CAT. B	CAT. C	PIEDI NICHEL NICKEL FEET	BOX CONTENITORE STORAGE BED
ECOPELLE/ECONABUK ECOLEATHER/ECONABUK	LINO/VELLUTO LINEN/VELVET	PELLE LEATHER		
3.696	4.158	4.324	+ 211	+ 680
mc 0,55 - Kg 75			mc 0,40 - Kg 66	

LETTO SIBILLA LIGHT VERSIONE GIROLETTO TUTTO IMBOTTITO

SIBILLA LIGHT BED
VERSION WITH ALL UPHOLSTERED
BED SURROUND

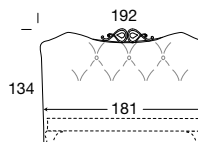

NOCE-FRASSINO / WALNUT-ASHWOOD

LETTO DA 160 - (CONTENITORE CON RETE BASCULANTE OPTIONAL)
160 CM WIDE BED - (OPTIONAL BED STORAGE WITH TILTING BED BASE)

NEW



MISURE INTERNE 162X202 PER MATERASSO 160X200
INTERNAL DIMENSIONS 162X202 FOR MATTRESS 160X200

PFN5701K			OPTIONAL	
CAT. A	CAT. B	CAT. C	PIEDI NICHEL NICKEL FEET	BOX CONTENITORE STORAGE BED
ECOPELLE/ECONABUK ECOLEATHER/ECONABUK	LINO/VELLUTO LINEN/VELVET	PELLE LEATHER		
3.442	3.584	4.606	+ 211	+ 680
mc 0,90 - Kg 75			mc 0,40 - Kg 66	

GIROLETTO
IMBOTTITO
UPHOLSTERED
SURROUND

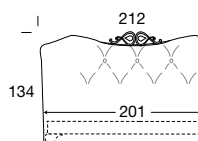

NOCE-FRASSINO / WALNUT-ASHWOOD

LETTO DA 180 - (CONTENITORE CON RETE BASCULANTE OPTIONAL)
180 CM WIDE BED - (OPTIONAL BED STORAGE WITH TILTING BED BASE)

NEW



MISURE INTERNE 182X202 PER MATERASSO 180X200
INTERNAL DIMENSIONS 182X202 FOR MATTRESS 180X200

PFN5721K			OPTIONAL	
CAT. A	CAT. B	CAT. C	PIEDI NICHEL NICKEL FEET	BOX CONTENITORE STORAGE BED
ECOPELLE/ECONABUK ECOLEATHER/ECONABUK	LINO/VELLUTO LINEN/VELVET	PELLE LEATHER		
3.578	3.732	4.836	+ 211	+ 750
mc 0,95 - Kg 80			mc 0,40 - Kg 66	

MAGGIORAZIONI E RIDUZIONI SURCHARGES AND REDUCTIONS

PER LONGHERONI PIÙ LUNGI
O PIÙ CORTI APPLICARE
MAGG. DEL **+ 15%**
FOR LONGER OR SHORTER
SIDES PLEASE ADD THE
FOLLOWING EXTRA CHARGE

OPTIONAL OPTIONAL

+ 222
SOLLEVAMENTO ORIZZONTALE
HORIZONTAL LIFTING MECHANISM

KIT N. 2 PIEDI IN METALLO
H. 18 CM PER LETTO
NELLE FINITURE:
**NICHEL SPAZZOLATO
BRONZO SPAZZOLATO
OTTONE BRUNITO**

KIT N. 2 METAL FEET H. 18 CM
FOR BED IN FINISHES:
**BRUSHED NICKEL
BRUSHED BRONZE
BURNISHED BRASS**

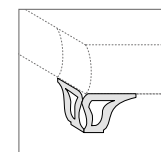

+ 557

RETE A DOGHE SLATTED BED BASE

RETE 160x200 PER LETTI
DA 160
BED BASE 160x200 FOR
160 CM WIDE BEDS

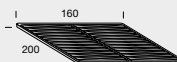

ACS5160K

433

RETE 180x200 PER LETTI
DA 180
BED BASE 180x200 FOR
180 CM WIDE BEDS



ACS5180K

593

LETTI BEDS

LETTO SIBILLA VERSIONE GIROLETTO LEGNO E IMBOTTITO

SIBILLA BED VERSION WITH WOODEN AND UPHOLSTERED BED SURROUND

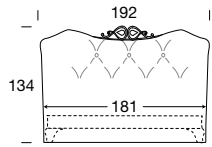

LETTO DA 160
160 CM WIDE BED



MISURE INTERNE 162X202 PER MATERASSO 160X200
INTERNAL DIMENSIONS 162X202 FOR MATTRESS 160X200

PFN5321K			OPTIONAL	
CAT. A	CAT. B	CAT. C		
ECOPELLE/ECONABUK ECOLEATHER/ECONABUK	LINO/VELLUTO LINEN/VELVET	PELLE LEATHER	PIEDI NICHEL NICKEL FEET	BOX CONTENITORE STORAGE BED
3.659	3.806	4.859	+ 211	+ 680
mc 0,90 – Kg 75			mc 0,40 – Kg 66	

NOCE-FRASSINO / WALNUT-ASHWOOD

LETTO DA 180
180 CM WIDE BED

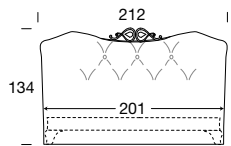

MISURE INTERNE 182X202 PER MATERASSO 180X200
INTERNAL DIMENSIONS 182X202 FOR MATTRESS 180X200

PFN5401K			OPTIONAL	
CAT. A	CAT. B	CAT. C		
ECOPELLE/ECONABUK ECOLEATHER/ECONABUK	LINO/VELLUTO LINEN/VELVET	PELLE LEATHER	PIEDI NICHEL NICKEL FEET	BOX CONTENITORE STORAGE BED
3.806	3.881	5.016	+ 211	+ 750
mc 0,90 – Kg 80			mc 0,40 – Kg 66	

NOCE-FRASSINO / WALNUT-ASHWOOD

LETTO RAISSA TESTIERA E GIROLETTO SUPERIORE IMBOTTITI

RAISSA BED UPHOLSTERED TOP BED SURROUND AND PANEL

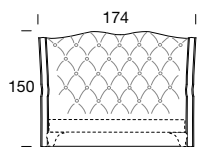

LETTO DA 160
160 CM WIDE BED



MISURE INTERNE 162X197 PER MATERASSO 160X195
INTERNAL DIMENSIONS 162X197 FOR MATTRESS 160X195

PFN5201K			OPTIONAL	
CAT. A	CAT. B	CAT. C		
ECOPELLE/ECONABUK ECOLEATHER/ECONABUK	LINO/VELLUTO LINEN/VELVET	PELLE LEATHER	PIEDI NICHEL NICKEL FEET	BOX CONTENITORE STORAGE BED
4.276	4.344	5.848	+ 211	+ 680
mc 0,90 – Kg 75			mc 0,40 – Kg 66	

NOCE-FRASSINO / WALNUT-ASHWOOD

LETTO DA 180
180 CM WIDE BED

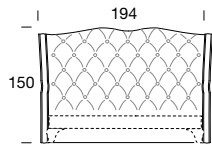

MISURE INTERNE 182X197 PER MATERASSO 180X195
INTERNAL DIMENSIONS 182X197 FOR MATTRESS 180X195

PFN5281K			OPTIONAL	
CAT. A	CAT. B	CAT. C		
ECOPELLE/ECONABUK ECOLEATHER/ECONABUK	LINO/VELLUTO LINEN/VELVET	PELLE LEATHER	PIEDI NICHEL NICKEL FEET	BOX CONTENITORE STORAGE BED
4.424	4.578	6.274	+ 211	+ 750
mc 0,90 – Kg 80			mc 0,40 – Kg 66	

NOCE-FRASSINO / WALNUT-ASHWOOD

MAGGIORAZIONI E RIDUZIONI SURCHARGES AND REDUCTIONS

PER LONGHERONI PIÙ LUNGHI
O PIÙ CORTI APPLICARE
MAGG. DEL + 15%
FOR LONGER OR SHORTER
SIDES PLEASE ADD THE
FOLLOWING EXTRA CHARGE

OPTIONAL OPTIONAL

+ 222
SOLLEVAMENTO ORIZZONTALE
HORIZONTAL LIFTING MECHANISM

KIT N. 2 PIEDI IN METALLO
H. 18 CM PER LETTO
NELLE FINITURE:
NICHEL SPAZZOLATO
BRONZO SPAZZOLATO
OTTONE BRUNITO

KIT N. 2 METAL FEET H. 18 CM
FOR BED IN FINISHES:
BRUSHED NICKEL
BRUSHED BRONZE
BURNISHED BRASS

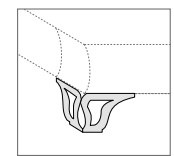

+ 557

RETE A DOGHE SLATTED BED BASE

RETE 160x195 PER LETTI
DA 160

BED BASE 160x195 FOR
160 CM WIDE BEDS

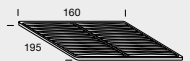

ACS5170K

433

RETE 180x195 PER LETTI
DA 180

BED BASE 180x195 FOR
180 CM WIDE BEDS



ACS5190K

593

RETE 160x200 PER LETTI
DA 160

BED BASE 160x200 FOR
160 CM WIDE BEDS



ACS5160K

433

RETE 180x200 PER LETTI
DA 180

BED BASE 180x200 FOR
180 CM WIDE BEDS



ACS5180K

593

PORTOFINO NOTTE - NIGHT

ARMADI SCORREVOLI SLIDING DOOR WARDROBES

ARMADIO PORTOFINO SCORREVOLE

CON TRAFORO CENTRALE

PORTOFINO WARDROBE
WITH SLIDING DOOR
WITH CENTRAL DECORATION

ATTREZZATURA INTERNA: 2 RIPIANI,
4 TUBI APPENDIABILI

INTERIOR FITTINGS: 2 SHELVES,
4 CLOTHES HANGING RAILS

MAGGIORAZIONE PER SCOCCA ARMADIO IN
PANNELLO IN LEGNO
INCREASE FOR WARDROBE STRUCTURE IN WOOD
PANEL.

+ 532

MAGG. TRAFORO DI COLORE DIVERSO
DAL FONDO
SURCH. FOR DECORATION WITH
DIFFERENT COLOUR FROM THE BOTTOM
PANEL.

+ 3%

NOCE-FRASSINO / WALNUT-ASHWOOD

ARMADIO 2 ANTE SCORREVOLI
WARDROBE WITH 2 WIDE SLIDING DOORS

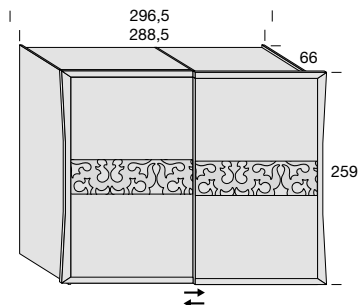

PANNELLO LEGNO
WOOD PANEL

PFN8081K	OPTIONAL
	ACS3100K L. 140
6.383	+ 470
mc 1,50 – Kg 262	mc 0,44 – Kg 54

ARMADIO 2 ANTE SCORREVOLI
WARDROBE WITH 2 WIDE SLIDING DOORS

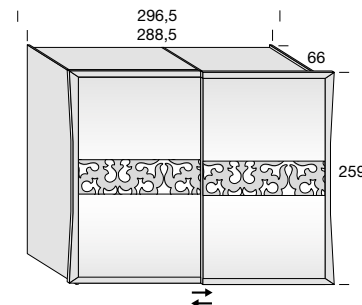

SPECIFICARE SE VETRO SERIGRAFATO MILLERIGHE O SPECCHIO ARGENTO O SPECCHIO BRONZO
SPECIFY IF "MILLERIGHE" SCREEN-PRINTED GLASS OR BRONZE OR SILVER MIRROR

PFN8001K	OPTIONAL
	ACS3100K L. 140
6.100	+ 470
mc 1,50 – Kg 282	mc 0,44 – Kg 54

ARMADIO PORTOFINO SCORREVOLE

CON TRAFORO CENTRALE

PORTOFINO WARDROBE
WITH SLIDING DOOR
WITH CENTRAL DECORATION

ATTREZZATURA INTERNA: 3 RIPIANI,
6 TUBI APPENDIABILI

INTERIOR FITTINGS: 3 SHELVES,
6 CLOTHES HANGING RAILS

MAGGIORAZIONE PER SCOCCA ARMADIO IN
PANNELLO IN LEGNO
INCREASE FOR WARDROBE STRUCTURE IN WOOD
PANEL.

+ 582

MAGG. TRAFORO DI COLORE DIVERSO
DAL FONDO
SURCH. FOR DECORATION WITH
DIFFERENT COLOUR FROM THE BOTTOM
PANEL.

+ 3%

NOCE-FRASSINO / WALNUT-ASHWOOD

ARMADIO 3 ANTE SCORREVOLI
WARDROBE WITH 2 WIDE SLIDING DOORS

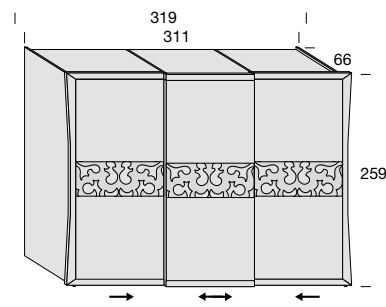

PANNELLO LEGNO
WOOD PANEL

PFN8361K	OPTIONAL
	ACS3110K L. 100
8.540	+ 451
mc 1,75 – Kg 300	mc 0,44 – Kg 42

ARMADIO 3 ANTE SCORREVOLI
WARDROBE WITH 2 WIDE SLIDING DOORS

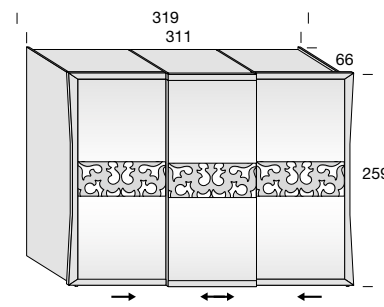

SPECIFICARE SE VETRO SERIGRAFATO MILLERIGHE O SPECCHIO ARGENTO O SPECCHIO BRONZO
SPECIFY IF "MILLERIGHE" SCREEN-PRINTED GLASS OR BRONZE OR SILVER MIRROR

PFN8341K	OPTIONAL
	ACS3110K L. 100
8.360	+ 451
mc 1,75 – Kg 300	mc 0,44 – Kg 42

ATTREZZATURA INTERNA ARMADIO SCORREVOLE DECORATIVO COLOR OLMO SBIANCATO

INTERIOR FITTINGS
WARDROBE WITH SLIDING
DOORS

BLEACHED ELM COLOR
DECORATION

DIVISORIO INTERNO SP. 2.5
INTERNAL PARTITIONS TH. 2.5

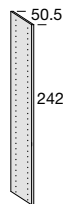

DIVISORIO INTERNO SP. 2.5
INTERNAL PARTITIONS TH. 2.5

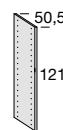

KIT 2 LUCI LED VERTICALI H. 240
KIT FOR 2 VERTICAL LED LIGHTS
H. 240



CASSETTIERA "EASY" 3 CASSETTI
"EASY" DRAWER UNIT WITH 3 DRAWERS

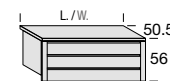

ACS1022C	ACS1021C
415	222
mc 0,10 – Kg 24	mc 0,05 – Kg 10

CON SENSORE E TRASFORMATORE (1 DX E 1 SX)
WITH SENSOR AND TRANSFORMER (1 RH AND 1 LH)

ACS1080K	ACS3110K	ACS3100K
637	L.100	L.140
	451	470
	mc 0,35 – Kg 42	mc 0,44 – Kg 54

STRUTTURA INTERNA DECORATIVO COLOR OLMO SBIANCATO ED ESTERNO NOCE TANGANICA O FRASSINO
INTERNAL STRUCTURE IN BLEACHED ELM COLOR DECORATION AND EXTERNAL STRUCTURE IN TANGANICA WALNUT OR ASHWOOD

ARMADIO CAPRI SCORREVOLE CAPRI SLIDING DOOR WARDROBE

ARMADIO 2 ANTE SCORREVOLI
WARDROBE WITH 2 WIDE SLIDING DOORS

ATTREZZATURA INTERNA: 2 RIPIANI,
4 TUBI APPENDIABILI
INTERIOR FITTINGS: 2 SHELVES,
4 CLOTHES HANGING RAILS

MAGGIORAZIONE PER SCOCCA ARMADIO IN
PANNELLO IN LEGNO
INCREASE FOR WARDROBE STRUCTURE IN WOOD
PANEL.

+ 532

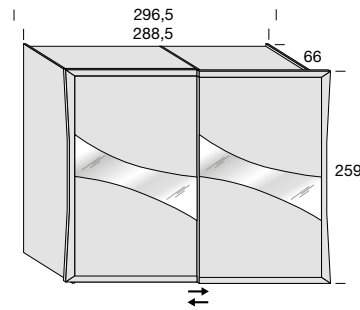

SPECCHIO ARGENTO
SILVER MIRROR

PFN8101K

OPTIONAL

ACS3100K L. 140



NOCE-FRASSINO / WALNUT-ASHWOOD

5.995

+ 470

mc 1,50 - Kg 282

mc 0,44 - Kg 54

MAGGIORAZIONI E RIDUZIONI SURCHARGES AND REDUCTIONS

RIDUZIONI SINGOLE
SINGLE ADJUSTMENTS

LUNGHEZZA LENGTH	+ 30%
PROFONDITÀ DEPTH	
ALTEZZA HEIGHT	

RIDUZIONI COMBinate TRA LORO
COMBINED ADJUSTMENTS

RIDUZIONE DI 2 O 3 MISURE REDUCTION OF 2 OR 3 DIMENSIONS	+ 40%
---	--------------

ES. RIDUZIONE IN LUNGHEZZA +
PROFONDITÀ O PROFONDITÀ + ALTEZZA ECC.
EX. OF REDUCTION IN LENGTH +
DEPTH OR DEPTH + HEIGHT ETC.

MAGG. ANTA SPORGENTE A SX
SURCH. FOR LH PROTRUDING DOOR **+ 5%**

PER ULTERIORI MODIFICHE
RICHIEDERE PREVENTIVO
FOR MODIFICATIONS
ASK FOR AN ESTIMATE.

OPTIONAL OPTIONAL

CASSETTIERA "EASY" 3 CASSETTI
"EASY" DRAWER UNIT WITH 3 DRAWERS

CASSETTIERA 2 CASSETTI
DRAWER UNIT WITH 2 DRAWERS

POSSIBILITÀ DI FRONTALE DIVERSO
DALLA SCOCCA, SPECIFICARE LA
FINITURA SCELTA

IN CASE OF FRONT DIFERENT FROM
THE CARCASE CONSIDER THE
HIGHER PRICE OF THE CHOOSEN
FINISH

RIPIANI SP. 3,6 CM
SHELVES TH. 3,6 CM

TUBO APPENDIABILI
CLOTHES HANGING RAILS

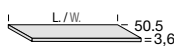

ACS1014C ACS1013C ACS1012C ACS1016C ACS1011C

L. 45 L. 70 L. 90 L. 100 L. 140

136 162 186 229 241

mc 0,04 - Kg 4 mc 0,05 - Kg 8 mc 0,05 - Kg 11 mc 0,06 - Kg 13 mc 0,07 - Kg 15

ACS1104C ACS1103C ACS1102C ACS1106C ACS1101C

L. 45 L. 70 L. 90 L. 100 L. 140

44 44 55 55 55

PORTOFINO NOTTE - NIGHT

ARMADI BATTENTE HINGED DOOR WARDROBES

ARMADIO PORTOFINO BATTENTE H. 259 PORTOFINO WARDROBE WITH HINGED DOOR H. 259

**ATTREZZATURA INTERNA: 2 RIPIANI,
4 TUBI APPENDIABILI**
INTERIOR FITTINGS: 2 SHELVES,
4 CLOTHES HANGING RAILS

MAGG. TRAFORO DI COLORE DIVERSO
DAL FONDO
SURCH. FOR DECORATION WITH
DIFFERENT COLOUR FROM THE BOTTOM
PANEL. **+ 3%**

ARMADIO 4 ANTE BATTENTI
WARDROBE WITH 4 HINGED DOORS

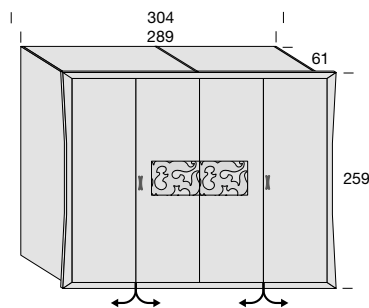

TRAFORO CENTRALE, SPECIFICARE IL TIPO DI MANGLIA SCELTA
CENTRAL DECORATION, SPECIFY THE TYPE OF HANDLE CHOICE

PFN8021K	OPTIONAL
	ACS1006K L. 140
7.149	+ 686
mc 1,60 – Kg 260	mc 0,44 – Kg 54

ARMADIO 4 ANTE BATTENTI
WARDROBE WITH 4 HINGED DOORS

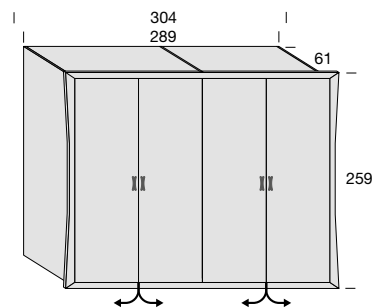

SPECIFICARE IL TIPO DI MANGLIA SCELTA
SPECIFY THE TYPE OF HANDLE CHOICE

PFN8041K	OPTIONAL
	ACS1006K L. 140
6.983	+ 686
mc 1,60 – Kg 260	mc 0,44 – Kg 54

NOCE-FRASSINO / WALNUT-ASHWOOD

ATTREZZATURA INTERNA ARMADIO BATTENTE FINITURA FRASSINO TINTA ACACIA

INTERIOR FITTINGS
WARDROBE WITH HINGED
DOORS
ACACIA STAINED ASHWOOD FINISH

DIVISORIO INTERNO SP. 2.5
INTERNAL PARTITIONS TH. 2.5

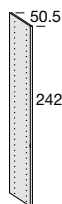

ACS1022C
415
mc 0,10 – Kg 24

DIVISORIO INTERNO SP. 2.5
INTERNAL PARTITIONS TH. 2.5

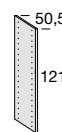

ACS1021C
229
mc 0,05 – Kg 10

KIT 2 LUCI LED L. 100
KIT FOR 2 LED LIGHTS W. 100

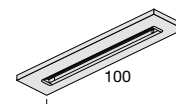

CON SENSORE E TRASFORMATORE (1 DX E 1 SX)
WITH SENSOR AND TRANSFORMER (1 RH AND 1 LH)

ACS1080K
637

CASSETTIERA "EASY" 3 CASSETTI
"EASY" DRAWER UNIT WITH 3 DRAWERS

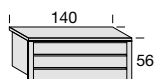

ACS1006K
L. 140
686
mc 0,44 – Kg 54

CASSETTIERA 2 CASSETTI
DRAWER UNIT WITH 2 DRAWERS

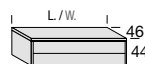

ACS1004K	ACS1002K	ACS1000K
L. 70	L. 90	L. 140
637	736	945
mc 0,35 – Kg 15	mc 0,23 – Kg 22	mc 0,35 – Kg 30

CASSETTIERA 4 CASSETTI
DRAWER UNIT WITH 4 DRAWERS

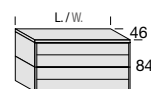

ACS1005K	ACS1003K	ACS1001K
L. 70	L. 90	L. 140
1.107	1.255	1.686
mc 0,65 – Kg 30	mc 0,41 – Kg 45	mc 0,62 – Kg 60

**ARMADIO PORTOFINO
BATTENTE H. 227**
PORTOFINO WARDROBE
WITH HINGED DOOR H. 227

ARMADIO 3 ANTE BATTENTI
WARDROBE WITH 3 HINGED DOORS

**ATTREZZATURA INTERNA: 2 RIPIANI,
4 TUBI APPENDIABILI**
INTERIOR FITTINGS: 2 SHELVES,
4 CLOTHES HANGING RAILS

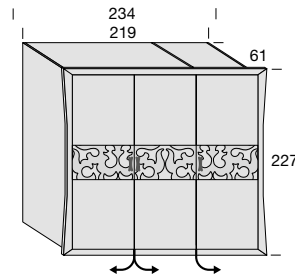

**MAGG. TRAFORO DI COLORE DIVERSO
DAL FONDO**
SURCH. FOR DECORATION WITH
DIFFERENT COLOUR FROM THE BOTTOM
PANEL. + 3%

TRAFORO CENTRALE, SPECIFICARE IL TIPO DI MANGLIA SCELTA
CENTRAL DECORATION, SPECIFY THE TYPE OF HANDLE CHOICE

	PFN8071K	OPTIONAL	
		L. 140	L. 70
NOCE-FRASSINO / WALNUT-ASHWOOD	6.525	+ 686	+ 637
	mc 1,20 – Kg 220	mc 0,44 – Kg 54	mc 0,35 – Kg 15

**MAGGIORAZIONI E RIDUZIONI
SURCHARGES AND REDUCTIONS**

RIDUZIONI SINGOLE
SINGLE ADJUSTMENTS

LUNGHEZZA LENGTH	+ 30%
PROFONDITÀ DEPTH	
ALTEZZA HEIGHT	

RIDUZIONI COMBinate TRA LORO
COMBINED ADJUSTMENTS

RIDUZIONE DI 2 O 3 MISURE REDUCTION OF 2 OR 3 DIMENSIONS	+ 40%
---	-------

ES. RIDUZIONE IN LUNGHEZZA +
PROFONDITÀ O PROFONDITÀ + ALTEZZA ECC.
EX. OF REDUCTION IN LENGTH +
DEPTH OR DEPTH + HEIGHT ETC.

**PER ULTERIORI MODIFICHE
RICHIEDERE PREVENTIVO
FOR MODIFICATIONS
ASK FOR AN ESTIMATE.**

**OPTIONAL
OPTIONAL**

CASSETTIERA "EASY" 3 CASSETTI
"EASY" DRAWER UNIT WITH 3 DRAWERS

CASSETTIERA 2 CASSETTI
DRAWER UNIT WITH 2 DRAWERS

**POSSIBILITÀ DI FRONTALE DIVERSO
DALLA SCOCCA, SPECIFICARE LA
FINITURA SCELTA**

IN CASE OF FRONT DIFERENT FROM
THE CARCASE CONSIDER THE
HIGHER PRICE OF THE CHOOSEN
FINISH

PORTOFINO NOTTE - NIGHT

COMODINO, COMÒ, SETTIMINO, SPECCHIERE E TOILETTE

BEDSIDE TABLE, CHEST OF DRAWERS, 6-DRAWER CHEST MIRRORS AND DRESSING TABLE

COMODINO, COMÒ, SETTIMINO PORTOFINO

PORTOFINO BEDSIDE TABLE, CHEST OF DRAWER AND 6-DRAWER CHEST

COMODINO 2 CASSETTI
BEDSIDE TABLE WITH 2 DRAWERS

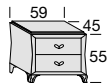

COMÒ 4 CASSETTI
4-DRAWER CHEST

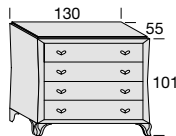

SETTIMINO 6 CASSETTI
6-DRAWERS UNIT

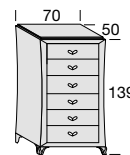

LE RIDUZIONI IN ALTEZZA SONO DA VALUTARE SINGOLARMENTE
HEIGHT REDUCTION HAVE TO BE EVALUATE SEPARATELY

SPORGENZA PIEDINI LEGNO CM 0.5 PER LATO
WOODEN FEET PROTRUSION CM 0.5 FOR SIDE

PFN7001K	OPTIONAL
	PIEDI NICHEL NICKEL FEET
1.318	+ 221
mc 0,18 – Kg 25	

SPORGENZA PIEDINI LEGNO CM 2.5 PER LATO
WOODEN FEET PROTRUSION CM 2.5 FOR SIDE

PFN6001K	OPTIONAL
	PIEDI NICHEL NICKEL FEET
2.879	+ 253
mc 0,83 – Kg 80	

SPORGENZA PIEDINI LEGNO CM 0.5 PER LATO
WOODEN FEET PROTRUSION CM 0.5 FOR SIDE

PFN6041K	OPTIONAL
	PIEDI NICHEL NICKEL FEET
2.879	+ 221
mc 0,60 – Kg 72	

SPECCHIERE MIRRORS

SPECCHIERA PORTOFINO
PORTOFINO MIRROR

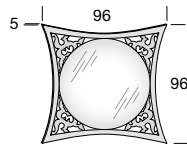

TRAFORATA
PERFORATED

PFN9001K
904
mc 0,10 – Kg 16

SPECCHIERA ELIOS
ELIOS MIRROR

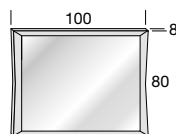

CORNICE IN LEGNO
WOODEN FRAME

DCN9010K
711
mc 0,08 – Kg 14

TOILETTE PORTOFINO PORTOFINO DRESSING TABLE

TOILETTE
DRESSING TABLE

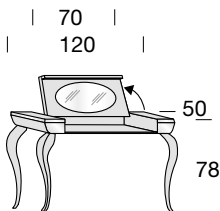

PFN7811K
2.960
mc 0,55 – Kg 30

MAGGIORAZIONI E RIDUZIONI SURCHARGES AND REDUCTIONS

RIDUZIONI SINGOLE
SINGLE ADJUSTMENTS

LUNGHEZZA LENGTH	+ 30%
PROFONDITÀ DEPTH	
NO RIDUZIONI IN ALTEZZA HEIGHT REDUCTIONS NOT POSSIBLE	

RIDUZIONI COMBinate TRA LORO
COMBINED ADJUSTMENTS

LUNGHEZZA + PROFONDITÀ LENGTH + DEPTH	+ 40%
--	--------------

OPTIONAL OPTIONAL

KIT PIEDI IN METALLO PER COMODINO E SETTIMINO CON MANIGLIE ABBINATE IN FINITURA:
NICHEL SPAZZOLATO
BRONZO SPAZZOLATO
OTTONE BRUNITO

METAL FEET KIT FOR BEDSIDE TABLE AND 6-DRAWERS CHEST WITH MATCHING HANDLES IN FINISH:
BRUSHED NICKEL
BRUSHED BRONZE
BURNISHED BRASS

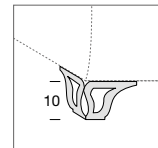

+ 802

KIT PIEDI IN METALLO PER COMO' CON MANIGLIE ABBINATE IN FINITURA:
NICHEL SPAZZOLATO
BRONZO SPAZZOLATO
OTTONE BRUNITO

METAL FEET KIT FOR CHEST OF DRAWER WITH MATCHING HANDLES IN FINISH:
BRUSHED NICKEL
BRUSHED BRONZE
BURNISHED BRASS

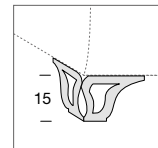

+ 1.063

VETRINE E SEDIE DISPLAY UNITS AND CHAIRS

VETRINA PORTOFINO CON TRAFORO LEGNO

PORTOFINO DISPLAY UNIT WITH WOODEN DECORATION

N.B.: SPORGENZA PIEDINI CM 2.5 PER LATO
N.B.: FEET PROTRUSION CM 2.5 FOR SIDE

LE RIDUZIONI IN ALTEZZA
SONO DA VALUTARE SINGOLARMENTE
HEIGHT REDUCTION
HAVE TO BE EVALUATE SEPARATELY

NOCE-FRASSINO / WALNUT-ASHWOOD

VETRINA 1 ANTA SX
DISPLAY UNIT WITH 1 DOOR LH

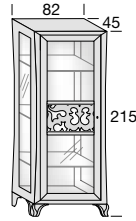

PFG3101K	OPTIONAL
	1 LED PIEDI NICHEL NICKEL FEET
2.584	
+118	+253
mc 0,95 – Kg 66	

VETRINA 1 ANTA DX
DISPLAY UNIT WITH 1 DOOR RH

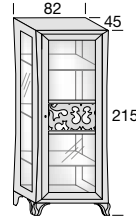

PFG3001K	OPTIONAL
	1 LED PIEDI NICHEL NICKEL FEET
2.584	
+118	+253
mc 0,95 – Kg 66	

VETRINA 2 ANTE
DISPLAY UNIT WITH 2 DOORS

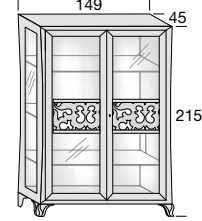

PFG3081K	OPTIONAL
	2 LED PIEDI NICHEL NICKEL FEET
3.553	
+236	+253
mc 1,55 – Kg 90	

VETRINA 2 ANTE
DISPLAY UNIT WITH 2 DOORS

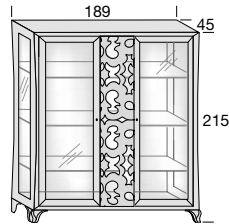

PFG3051K	OPTIONAL
	2 LED PIEDI NICHEL NICKEL FEET
4.320	
+236	+253
mc 0,85 – Kg 105	

N.B.: SPORGENZA PIEDINI CM 2.5 PER LATO
N.B.: FEET PROTRUSION CM 2.5 FOR SIDE

LE RIDUZIONI IN ALTEZZA
SONO DA VALUTARE SINGOLARMENTE
HEIGHT REDUCTION
HAVE TO BE EVALUATE SEPARATELY

NOCE-FRASSINO / WALNUT-ASHWOOD

VETRINA PORTOFINO WOOD CON PANNELLO TRAFORATO

PORTOFINO WOOD DISPLAY UNIT WITH PERFORATED PANEL

N.B.: SPORGENZA PIEDINI CM 2.5 PER LATO
N.B.: FEET PROTRUSION CM 2.5 FOR SIDE

LE RIDUZIONI IN ALTEZZA
SONO DA VALUTARE SINGOLARMENTE
HEIGHT REDUCTION
HAVE TO BE EVALUATE SEPARATELY

NOCE-FRASSINO / WALNUT-ASHWOOD

VETRINA 1 ANTA SX
DISPLAY UNIT WITH 1 DOOR LH

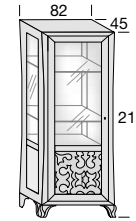

PFG3111K	OPTIONAL
	1 LED PIEDI NICHEL NICKEL FEET
2.941	
+118	+253
mc 0,95 – Kg 66	

VETRINA 1 ANTA DX
DISPLAY UNIT WITH 1 DOOR RH

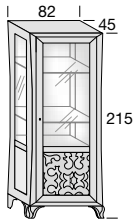

PFG3011K	OPTIONAL
	1 LED PIEDI NICHEL NICKEL FEET
2.941	
+118	+253
mc 0,95 – Kg 66	

VETRINA 2 ANTE
DISPLAY UNIT WITH 2 DOORS

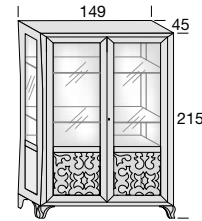

PFG3021K	OPTIONAL
	2 LED PIEDI NICHEL NICKEL FEET
4.245	
+236	+253
mc 1,55 – Kg 90	

SEDIE IMBOTTITE

CHAIRS UPHOLSTERED

SEDIA PENELOPE
PENELOPE CHAIR

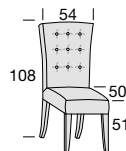

CML1011K		
CAT. A	CAT. B	CAT. C
ECOPELLE/ECONABUK	LINO/VELLUTO	PELLE
ECOLEATHER/ECONABUK	LINEN/VELVET	LEATHER
626	685	755

SEDIA COCÒ
COCÒ CHAIR

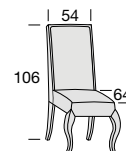

CML1401K		
CAT. A	CAT. B	CAT. C
ECOPELLE/ECONABUK	LINO/VELLUTO	PELLE
ECOLEATHER/ECONABUK	LINEN/VELVET	LEATHER
637	779	938

NOCE-FRASSINO / WALNUT-ASHWOOD

mc 0,37 – Kg 10

mc 0,37 – Kg 12

OPTIONAL OPTIONAL



KIT PIEDI IN METALLO
PER VETRINA CON CHIAVI
ABBINATE IN FINITURA:
NICHEL SPAZZOLATO
BRONZO SPAZZOLATO
OTTONE BRUNITO

METAL FEET KIT FOR DISPLAY UNIT
WITH MATCHING KEYS IN FINISH:

BRUSHED NICKEL
BRUSHED BRONZE
BURNISHED BRASS

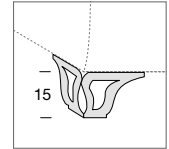

+1.063

PORTOFINO GIORNO - DAY

CREDENZE, TAVOLI E TAVOLINI

SIDEBOARDS, TABLES AND COFFEE TABLES

CREDENZE PORTOFINO PORTOFINO SIDEBOARDS

CREDENZA 2 ANTE BATTENTI
SIDEBOARD WITH 2 HINGED DOORS

CREDENZA 3 ANTE BATTENTI
SIDEBOARD WITH 3 HINGED DOORS

CREDENZA 2 ANTE BATTENTI
E 4 CASSETTI
SIDEBOARD WITH 2 HINGED DOORS
AND 4 DRAWERS

RIPIANI LEGNO AL POSTO DI VETRO
WOODEN SHELVES INSTEAD OF GLASS SHELVES + 165

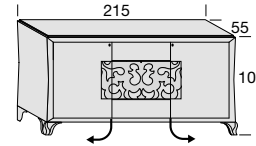
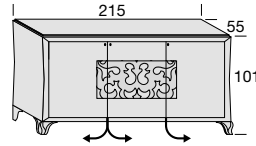
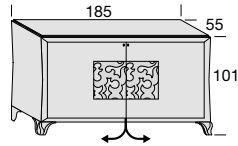

N.B.: SPORGENZA PIEDINI CM 2.5 PER LATO
N.B.: FEET PROTRUSION CM 2.5 FOR SIDE

LE RIDUZIONI IN ALTEZZA
SONO DA VALUTARE SINGOLARMENTE
HEIGHT REDUCTION
HAVE TO BE EVALUATE SEPARATELY

2 RIPIANI VETRO
2 GLASS SHELVES

PFG2001K	OPTIONAL
	PIEDI NICHEL NICKEL FEET
3.411	+ 253

3 RIPIANI VETRO
3 GLASS SHELVES

PFG2061K	OPTIONAL
	PIEDI NICHEL NICKEL FEET
3.615	+ 253

2 RIPIANI VETRO
2 GLASS SHELVES

PFG2051K	OPTIONAL
	PIEDI NICHEL NICKEL FEET
4.276	+ 253

NOCE-FRASSINO / WALNUT-ASHWOOD

mc 1,20 - Kg 86

mc 1,40 - Kg 96

mc 1,40 - Kg 96

TAVOLO PORTOFINO PORTOFINO TABLE

TAVOLO QUADRATO FISSO
SQUARE FIXED TABLE

TAVOLO RETTANGOLARE FISSO
RECTANGULAR FIXED TABLE

TAVOLO RETTANGOLARE FISSO
RECTANGULAR FIXED TABLE

NEW

NEW

NEW

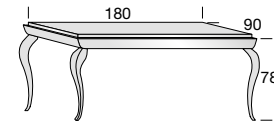
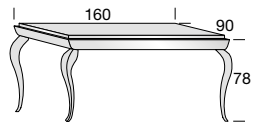
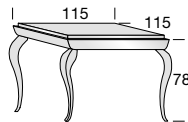

N.B.: SPORGENZA GAMBE CM 2.5 PER LATO
N.B.: LEG PROTRUSION CM 2.5 FOR SIDE

PFG4201K
2.212

PFG4231K
2.312

PFG4221K
2.542

NOCE-FRASSINO / WALNUT-ASHWOOD

mc 0,32 - Kg 40

mc 0,35 - Kg 47

mc 0,38 - Kg 50

TAVOLO QUADRATO ALLUNGABILE
SQUARE EXTENDING TABLE

TAVOLO RETTANGOLARE ALLUNGABILE
RECTANGULAR EXTENDING TABLE

TAVOLO RETTANGOLARE ALLUNGABILE
RECTANGULAR EXTENDING TABLE

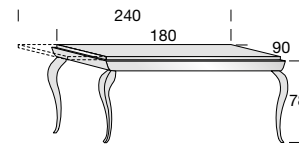
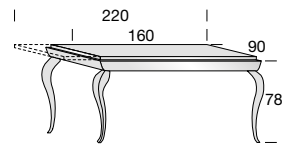
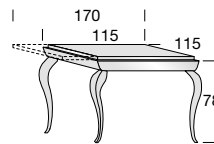

N.B.: SPORGENZA GAMBE CM 2.5 PER LATO
N.B.: LEG PROTRUSION CM 2.5 FOR SIDE

ALLUNGA DA 55
55 CM WIDE EXTENSION

PFG4001K
2.813

ALLUNGA DA 60
60 CM WIDE EXTENSION

PFG4031K
2.896

ALLUNGA DA 60
60 CM WIDE EXTENSION

PFG4021K
3.197

NOCE-FRASSINO / WALNUT-ASHWOOD

mc 0,32 - Kg 40

mc 0,35 - Kg 47

mc 0,38 - Kg 50

TAVOLINO PORTOFINO TRAFORO LEGNO

PORTOFINO SMALL TABLE WOODEN DECORATION

NEW

NEW

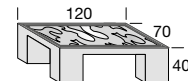
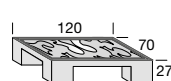
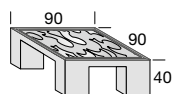
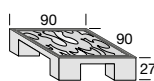

VETRO SU TOP
GLASS ON TOP

PFG4550K
1.263

VETRO SU TOP
GLASS ON TOP

PFG4570K
1.386

VETRO SU TOP
GLASS ON TOP

PFG4560K
1.410

VETRO SU TOP
GLASS ON TOP

PFG4580K
1.546

NOCE-FRASSINO / WALNUT-ASHWOOD

mc 0,26 - Kg 40

mc 0,38 - Kg 45

mc 0,29 - Kg 34

mc 0,44 - Kg 38

MAGGIORAZIONI E RIDUZIONI SURCHARGES AND REDUCTIONS

RIDUZIONI SINGOLE
SINGLE ADJUSTMENTS

LUNGHEZZA LENGTH	+ 30%
PROFONDITÀ DEPTH	+ 30%
NO RIDUZIONI IN ALTEZZA HEIGHT REDUCTIONS NOT POSSIBLE	

RIDUZIONI COMBinate TRA LORO
COMBINED ADJUSTMENTS

LUNGHEZZA + PROFONDITÀ LENGTH + DEPTH	+ 40%
--	-------

OPTIONAL OPTIONAL

CASSETTIERA INTERNA
PER CREDENZA 2
CASSETTI
DRAWERS UNIT WITH 2
DRAWERS FOR SIDEBOARD



ACS2000K

587

KIT PIEDI INTAGLIATI H.15 CM
KIT FOR CARVED FEET H. 15 CM

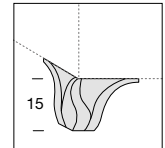

ACS4001K

285

KIT PIEDI IN METALLO PER
CREDENZE CON CHIAVI E
MANGIE ABBINATE
IN FINITURA:
NICHEL SPAZZOLATO
BRONZO SPAZZOLATO
OTTONE BRUNITO

METAL FEET KIT FOR SIDEBOARDS
WITH KEYS AND MATCHING
HANDLES IN FINISH
BRUSHED NICKEL
BRUSHED BRONZE
BURNISHED BRASS

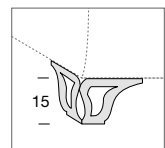

+1.063

PER MODIFICHE E
RIDUZIONI TAVOLI,
RICHIEDERE PREVENTIVO
FOR TABLE MODIFICATIONS
AND REDUCTIONS, ASK FOR
AN ESTIMATE

RIDUZIONI TAVOLINI
SMALL TABLE REDUCTIONS

1 RIDUZIONE 1 REDUCTION	+ 30%
2 RIDUZIONI 2 REDUCTIONS	+ 40%

BICOLORE TAVOLINO
BICOLOR SMALL TABLE

FONDO DEL DECORO +
TRAFORO DI COLORE
DIVERSO DALLA STRUTTURA
BOTTOM PANEL +
DECORATION IN A DIFFERENT
COLOUR FROM THE
STRUCTURE

+ 5%

TAVOLINI, CONSOLLE, PORTA TV E MADIE COFFEE TABLES, CONSOLE, TV UNIT AND CUPBOARDS

**TAVOLINO
CAPRI**
TRAFORO LEGNO
**CAPRI
SMALL TABLE**
WOODEN DECORATION

PIEDE INTAGLIO
CARVED FOOT

NEW

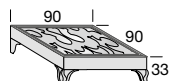

VETRO SU TOP
GLASS ON TOP

PFG4571K

OPTIONAL

1.587

mc 0,27 – Kg 30

PIEDI NICHEL
NICKEL FEET

+ 253

PIEDE INTAGLIO
CARVED FOOT

NEW

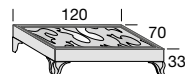

VETRO SU TOP
GLASS ON TOP

PFG4581K

OPTIONAL

1.728

mc 0,28 – Kg 32

PIEDI NICHEL
NICKEL FEET

+ 253

NOCE-FRASSINO / WALNUT-ASHWOOD

**CONSOLLE PORTOFINO
PORTOFINO CONSOLE**

CONSOLLE 1 CASSETTO
CONSOLE WITH 1 DRAWER

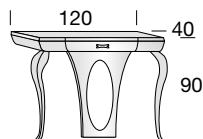

PFN7841K

NOCE-FRASSINO / WALNUT-ASHWOOD

2.255

mc 0,15 – Kg 33

**PORTA TV PORTOFINO
PORTOFINO TV UNIT**

BASE PORTA TV 2 ANTE, 1 CASSETTO E VANO
A GIORNO
TV BASE UNIT WITH 2 DOORS, 1 DRAWER
AND OPEN COMPART.

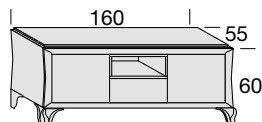

FIANCHI SAGOMATI, APERTURA PUSH-PULL
SHAPED SIDE PANELS, PUSH PULL OPENING

PFG7801K

OPTIONAL

2.639

mc 0,68 – Kg 56

PIEDI NICHEL
NICKEL FEET

+ 253

NOCE-FRASSINO / WALNUT-ASHWOOD

**CAPPOTTIERA PORTOFINO
PORTOFINO COAT**

1 ANTA, 1 RIPIANO LEGNO E 1 TUBO APPENDIABITI
1 DOOR, 1 WOODEN SHELF AND 1 CLOTHES HANGING RAIL

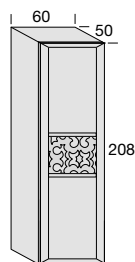

DX / RH
SX / LH

PFG7821K

OPTIONAL

2.435

mc 0,75 – Kg 50

ACS4001K

PIEDE INTAGLIO H. 15 CM
CARVED FEET H. 15 CM

+ 285

2 ANTE, 1 RIPIANO LEGNO E 1 TUBO APPENDIABITI
2 DOORS, 1 WOODEN SHELF AND 1 CLOTHES HANGING RAIL

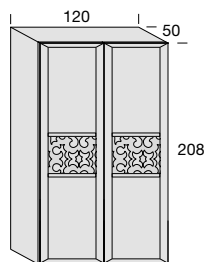

PFG7831K

OPTIONAL

3.466

mc 1,50 – Kg 70

ACS4001K

PIEDE INTAGLIO H. 15 CM
CARVED FEET H. 15 CM

+ 285

NOCE-FRASSINO / WALNUT-ASHWOOD

OPTIONAL
OPTIONAL

KIT PIEDI INTAGLIATI H.15 CM
KIT FOR CARVED FEET H. 15 CM

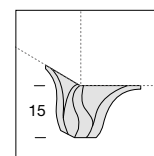

ACS4001K

285

KIT PIEDI IN METALLO PER
TAVOLINI IN FINITURA:
NICHEL SPAZZOLATO
BRONZO SPAZZOLATO
OTTONE BRUNITO
METAL FEET KIT FOR FINISHED
COFFEE TABLES:
BRUSHED NICKEL
BRUSHED BRONZE
BURNISHED BRASS

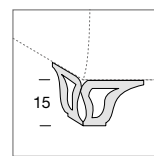

+1.063

MADIE DISPLAY UNITS

MADIA CON PIEDE INTAGLIO H. 76,5 P. 40

CUPBOARD WITH CARVED
FOOT H. 76,5 D. 40

NEW

2 ANTE LEGNO, 3 CASSETTI, 2 RIPIANI VETRO
2 WOODEN DOORS, 3 DRAWERS, 2 GLASS SHELVES

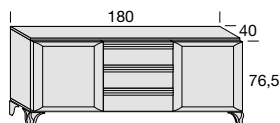

APERTURA PUSH-PULL
PUSH PULL OPENING

PFG2501K	OPTIONAL
	PIEDI NICHEL NICKEL FEET
2.687	+ 253
mc 0,54 – Kg 80	

NOCE-FRASSINO / WALNUT-ASHWOOD

2 ANTE TRAFORATE, 3 CASSETTI, 2 RIPIANI VETRO
2 PERFORATED DOORS, 3 DRAWERS, 2 GLASS SHELVES

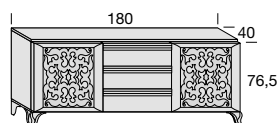

APERTURA PUSH-PULL
PUSH PULL OPENING

PFG2601K	OPTIONAL
	PIEDI NICHEL NICKEL FEET
3.054	+ 253
mc 0,54 – Kg 80	

OPTIONAL
OPTIONAL

KIT N. 4 PIEDI IN METALLO
PER MADIE NELLE FINITURE:
NICHEL SPAZZOLATO
BRONZO SPAZZOLATO
OTTONE BRUNITO
KIT N. 4 METAL FEET
FOR CUPBOARDS IN FINISHES:
BRUSHED NICKEL
BRUSHED BRONZE
BURNISHED BRASS

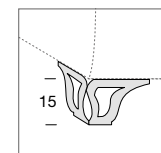

+1.063

MADIA CON PIEDE INTAGLIO H. 76,5 P. 50

CUPBOARD WITH CARVED
FOOT H. 76,5 D. 50

NEW

2 ANTE LEGNO, 3 CASSETTI, 2 RIPIANI VETRO
2 WOODEN DOORS, 3 DRAWERS, 2 GLASS SHELVES

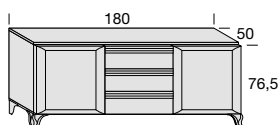

APERTURA PUSH-PULL
PUSH PULL OPENING

PFG2502K	OPTIONAL
	PIEDI NICHEL NICKEL FEET
2.904	+ 253
mc 0,67 – Kg 100	

NOCE-FRASSINO / WALNUT-ASHWOOD

2 ANTE TRAFORATE, 3 CASSETTI, 2 RIPIANI VETRO
2 PERFORATED DOORS, 3 DRAWERS, 2 GLASS SHELVES

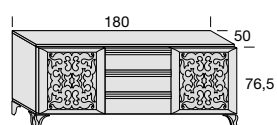

APERTURA PUSH-PULL
PUSH PULL OPENING

PFG2602K	OPTIONAL
	PIEDI NICHEL NICKEL FEET
3.265	+ 253
mc 0,67 – Kg 100	

BARRA LED A BASSO
CONSUMO
ACCENSIONE TOUCH
IN ALLUMINIO L. 37.2
LOW CONSUMPTION LED
BAR
TOUCH SWITCH
IN ALUMINIUM W. 37.2



ZZZFE22001

163

MADIA CON PIEDE INTAGLIO H. 136,5 P. 40

CUPBOARD WITH CARVED
FOOT H. 136,5 P. 40

NEW

4 ANTE LEGNO, 4 RIPIANI VETRO
4 WOODEN DOORS, 4 GLASS SHELVES

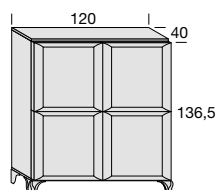

APERTURA PUSH-PULL
PUSH PULL OPENING

PFG2511K	OPTIONAL
	PIEDI NICHEL NICKEL FEET
2.554	+ 253
mc 0,70 – Kg 52	

NOCE-FRASSINO / WALNUT-ASHWOOD

2 ANTE VETRO, 2 ANTE LEGNO, 4 RIPIANI VETRO
2 GLASS DOORS, 2 WOODEN DOORS, 4 GLASS SHELVES

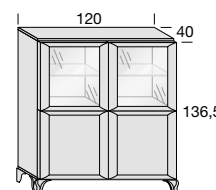

APERTURA PUSH-PULL
PUSH PULL OPENING

PFG2611K	OPTIONAL
	PIEDI NICHEL NICKEL FEET
2.554	+ 253
mc 0,70 – Kg 52	

ALIMENTATORE
POWER SUPPLY



ZZZFE22002

66

COLLEGAMENTO
A CARICO DEL CLIENTE
CONNECTIONS
TO BE MADE BY
THE CUSTOMER.

MADIA CON PIEDE INTAGLIO H. 136,5 P. 40

CUPBOARD WITH CARVED
FOOT H. 136,5 P. 40

NEW

4 ANTE TRAFORATE, 4 RIPIANI VETRO
4 PERFORATED DOORS, 4 GLASS SHELVES

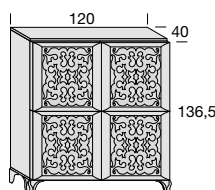

APERTURA PUSH-PULL
PUSH PULL OPENING

PFG2711K	OPTIONAL
	PIEDI NICHEL NICKEL FEET
3.222	+ 253
mc 0,70 – Kg 52	

NOCE-FRASSINO / WALNUT-ASHWOOD

2 ANTE VETRO, 2 ANTE TRAFORATE, 4 RIPIANI VETRO
2 GLASS DOORS, 2 PERFORATED DOORS, 4 GLASS SHELVES

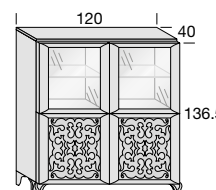

APERTURA PUSH-PULL
PUSH PULL OPENING

PFG2811K	OPTIONAL
	PIEDI NICHEL NICKEL FEET
3.072	+ 253
mc 0,70 – Kg 52	

MADIE DISPLAY UNITS

MADIA H. 63 P. 40 CUPBOARD H. 63 D. 40

4 ANTE LEGNO, 2 RIPIANI VETRO
4 WOODEN DOORS, 2 GLASS SHELVES

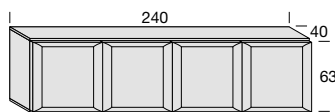

APERTURA PUSH-PULL
PUSH PULL OPENING

PFC6111K	OPTIONAL	
	PIEDI INTAGLIO H. 15 CM CARVED FEET H. 15 CM	PIEDI NICHEL NICKEL FEET
2.669		
	+ 285	+ 253

NOCE-FRASSINO / WALNUT-ASHWOOD

mc 0,72 – Kg 112

4 ANTE TRAFORATE, 2 RIPIANI VETRO
4 PERFORATED DOORS, 2 GLASS SHELVES

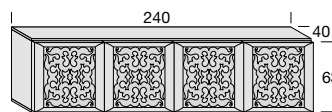

APERTURA PUSH-PULL
PUSH PULL OPENING

PFC6181K	OPTIONAL	
	PIEDI INTAGLIO H. 15 CM CARVED FEET H. 15 CM	PIEDI NICHEL NICKEL FEET
3.463		
	+ 285	+ 253

mc 0,72 – Kg 112

OPTIONAL OPTIONAL

KIT N. 4 PIEDI IN METALLO
PER MADIE NELLE FINITURE:
NICHEL SPAZZOLATO
BRONZO SPAZZOLATO
OTTONE BRUNITO
KIT N. 4 METAL FEET
FOR CUPBOARDS IN FINISHES:
BRUSHED NICKEL
BRUSHED BRONZE
BURNISHED BRASS

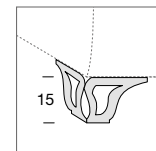

+1.063

MADIA H. 63 P. 50 CUPBOARD H. 63 D. 50

4 ANTE LEGNO, 2 RIPIANI VETRO
4 WOODEN DOORS, 2 GLASS SHELVES



APERTURA PUSH-PULL
PUSH PULL OPENING

PFC6115K	OPTIONAL	
	PIEDI INTAGLIO H. 15 CM CARVED FEET H. 15 CM	PIEDI NICHEL NICKEL FEET
2.946		
	+ 285	+ 253

NOCE-FRASSINO / WALNUT-ASHWOOD

mc 0,90 – Kg 140

4 ANTE TRAFORATE, 2 RIPIANI VETRO
4 PERFORATED DOORS, 2 GLASS SHELVES



APERTURA PUSH-PULL
PUSH PULL OPENING

PFC6185K	OPTIONAL	
	PIEDI INTAGLIO H. 15 CM CARVED FEET H. 15 CM	PIEDI NICHEL NICKEL FEET
3.745		
	+ 285	+ 253

mc 0,90 – Kg 140

BARRA LED A BASSO
CONSUMO
ACCENSIONE TOUCH
IN ALLUMINIO L. 37.2
LOW CONSUMPTION LED
BAR
TOUCH SWITCH
IN ALUMINIUM W. 37.2



ZZZFE22001

163

ALIMENTATORE
POWER SUPPLY



ZZZFE22002

66

COLLEGAMENTO
A CARICO DEL CLIENTE
CONNECTIONS
TO BE MADE BY
THE CUSTOMER.

COMPOSIZIONE 154

COMPOSITION 154

PAG. 92-93 CATALOGO "MODOZINE" E PAG. 6-7 "PORTOFINO NEW"

PAGE 92-93 "MODOZINE" CATALOGUE AND PAGE 6-7 "PORTOFINO NEW"

		NOCE FRASSINO	
1	PFN5321K	LETTO SIBILLA DA 160 IMBOTTITO RIVESTITO IN ECONABUK CAT. A 160 CM WIDE SIBILLA UPHOLSTERED BED WITH ECONABUK COVER CAT. A	3.659
1	PFN6001K	COMO 4 CASSETTI 4-DRAWER CHEST	2.879
2	PFN7001K	COMODINO 2 CASSETTI BEDSIDE TABLE WITH 2 DRAWERS	2.636
1	PFN8001K	ARMADIO 2 ANTE SCORREVOLI E TRAFORO CENTRALE WARDROBE WITH 2 SLIDING DOORS AND CENTRAL DECORATION	6.100
PREZZO TOTALE COMPOSIZIONE TOTAL PRICE FOR COMPOSITION		15.274	



COMPOSIZIONE 161

COMPOSITION 161

PAG. 40-41 CATALOGO "PORTOFINO" E PAG. 20-21 "PORTOFINO NEW"

PAGE 40-41 "PORTOFINO" CATALOGUE AND PAGE 20-21 "PORTOFINO NEW"

		NOCE FRASSINO	
1	PFN5321K	LETTO SIBILLA DA 160 IMBOTTITO RIVESTITO IN ECOPELLE CAT. A 160 CM WIDE SIBILLA UPHOLSTERED BED WITH ECOLEATHER COVER CAT. A	3.659
1	PFN6001K	COMO 4 CASSETTI 4-DRAWER CHEST	2.879
2	PFN7001K	COMODINO 2 CASSETTI BEDSIDE TABLE WITH 2 DRAWERS	2.636
PREZZO TOTALE COMPOSIZIONE TOTAL PRICE FOR COMPOSITION		9.174	



COMPOSIZIONE 157

COMPOSITION 157

PAG. 14-15 CATALOGO "PORTOFINO" E PAG. 28-29 "PORTOFINO NEW"

PAGE 14-15 "PORTOFINO" CATALOGUE AND PAGE 28-29 "PORTOFINO NEW"

		NOCE FRASSINO	
1	PFN5001K	LETTO PORTOFINO DA 160 CON PANNELLO TRAFORATO 160 CM WIDE PORTOFINO BED WITH PERFORATED PANEL	3.375
1	PFN6001K	COMO 4 CASSETTI 4-DRAWER CHEST	2.879
2	PFN7001K	COMODINO 2 CASSETTI BEDSIDE TABLE WITH 2 DRAWERS	2.636
PREZZO TOTALE COMPOSIZIONE TOTAL PRICE FOR COMPOSITION		8.890	



COMPOSIZIONE 158

COMPOSITION 158

PAG. 20-21 CATALOGO "PORTOFINO" E PAG. 34-35 "PORTOFINO NEW"

PAGE 20-21 "PORTOFINO" CATALOGUE AND PAGE 34-35 "PORTOFINO NEW"

		NOCE FRASSINO	
1	PFN5001K	LETTO PORTOFINO DA 160 CON PANNELLO TRAFORATO E PIEDE NICHEL 160 CM WIDE PORTOFINO BED WITH PERFORATED PANEL AND NICKEL FOOT	3.586
1	PFN6001K	COMO 4 CASSETTI CON PIEDE NICHEL 4-DRAWER CHEST WITH NICKEL FOOT	3.132
2	PFN7001K	COMODINO 2 CASSETTI CON PIEDE NICHEL BEDSIDE TABLE WITH 2 DRAWERS AND NICKEL FOOT	3.078
PREZZO TOTALE COMPOSIZIONE TOTAL PRICE FOR COMPOSITION		9.796	



COMPOSIZIONI A CATALOGO
CATALOGUE COMPOSITIONS

COMPOSIZIONE 159

COMPOSITION 159

PAG. 24-25 CATALOGO "PORTOFINO" E PAG. 38-39 "PORTOFINO NEW"
PAGE 24-25 "PORTOFINO" CATALOGUE AND PAGE 38-39 "PORTOFINO NEW"

		NOCE FRASSINO
1	PFN5001K LETTO PORTOFINO DA 160 CON PANNELLO TRAFORATO 160 CM WIDE PORTOFINO BED WITH PERFORATED PANEL	3.375
1	PFN6001K COMO 4 CASSETTI 4-DRAWER CHEST	2.879
2	PFN7001K COMODINO 2 CASSETTI BEDSIDE TABLE WITH 4 DRAWERS	2.636
1	PFN8001K ARMADIO 2 ANTE SCORREVOLI CON VETRO MILLERIGHE E TRAFORO CENTRALE WARDROBE WITH 2 SLIDING DOORS WITH "MILLERIGHE" GLASS AND CENTRAL DECORATION	6.100
PREZZO TOTALE COMPOSIZIONE TOTAL PRICE FOR COMPOSITION		14.990



COMPOSIZIONE 160

COMPOSITION 160

PAG. 32-33 CATALOGO "PORTOFINO" E PAG. 46-47 "PORTOFINO NEW"
PAGE 32-33 "PORTOFINO" CATALOGUE AND PAGE 46-47 "PORTOFINO NEW"

		NOCE FRASSINO
1	PFN5441K LETTO TEODORA DA 160 CON PANNELLO IMBOTTITO RIVESTITO IN ECOPELLE CAT. A 160 CM WIDE TEODORA BED WITH UPHOLSTERED PANEL WITH ECOLEATHER COVER CAT. A	3.696
1	PFN6001K COMO 4 CASSETTI 4-DRAWER CHEST	2.879
2	PFN7001K COMODINO 2 CASSETTI BEDSIDE TABLE WITH 2 DRAWERS	2.636
1	PFN8001K ARMADIO 2 ANTE SCORREVOLI CON VETRO MILLERIGHE E TRAFORO CENTRALE WARDROBE WITH 2 SLIDING DOORS WITH "MILLERIGHE" GLASS AND CENTRAL DECORATION	6.100
PREZZO TOTALE COMPOSIZIONE TOTAL PRICE FOR COMPOSITION		15.311



COMPOSIZIONE 156

COMPOSITION 156

PAG. 110-111 CATALOGO "MODOZINE" E PAG. 52-53 "PORTOFINO NEW"
PAGE 110-111 "MODOZINE" CATALOGUE AND PAGE 52-53 "PORTOFINO NEW"

		NOCE FRASSINO
1	PFN5601K LETTO FRIDA DA 160 CON PANNELLO IMBOTTITO RIVESTITO IN ECONABUK CAT. A 160 CM WIDE FRIDA BED WITH UPHOLSTERED PANEL AND ECONABUK COVER CAT. A	3.869
1	PFN6001K COMO 4 CASSETTI 4-DRAWER CHEST	2.879
2	PFN7001K COMODINO 2 CASSETTI BEDSIDE TABLE WITH 2 DRAWERS	2.636
1	PFN8101K ARMADIO CAPRI 2 ANTE SCORREVOLI CON SPECCHIO ARGENTO CAPRI WARDROBE WITH 2 SLIDING DOORS WITH SILVER MIRROR	5.995
PREZZO TOTALE COMPOSIZIONE TOTAL PRICE FOR COMPOSITION		15.379



COMPOSIZIONE 162

COMPOSITION 162

PAG. 52-53 CATALOGO "PORTOFINO" E PAG. 66-67 "PORTOFINO NEW"
PAGE 52-53 "PORTOFINO" CATALOGUE AND PAGE 66-67 "PORTOFINO NEW"

		NOCE FRASSINO
1	PFN5201K LETTO RAISSA DA 160 CON PANNELLO IMBOTTITO RIVESTITO IN ECOPELLE CAT. A 160 CM WIDE RAISSA BED WITH UPHOLSTERED PANEL WITH ECOLEATHER COVER CAT. A	4.276
1	PFN6001K COMO 4 CASSETTI 4-DRAWER CHEST	2.879
2	PFN7001K COMODINO 2 CASSETTI BEDSIDE TABLE WITH 2 DRAWERS	2.636
PREZZO TOTALE COMPOSIZIONE TOTAL PRICE FOR COMPOSITION		9.791



COMPOSIZIONE 151

COMPOSITION 151

PAG. 72-73 CATALOGO "MODOZINE" E PAG. 70-71 "PORTOFINO NEW"

PAGE 72-73 "MODOZINE" CATALOGUE AND PAGE 70-71 "PORTOFINO NEW"

		NOCE FRASSINO	
1	PFG4021K	TAVOLO PORTOFINO RETTANGOLARE ALLUNGABILE MIS. 180/240X90 PORTOFINO EXTENDING RECTANGULAR TABLE DIM. 180/240X90	3.197
1	PFG2051K	CREDENZA 2 ANTE E 4 CASSETTI SIDEBOARD WITH 2 DOORS AND 4 DRAWERS	4.276
4	CML1401K	SEDIA COCÒ RIVESTITA IN ECOPELLE CAT.A COCO CHAIR WITH ECOLEATHER COVER CAT.A	2.548
1	PFC0116K	COMPONIBILE PORTOFINO COMPOSIZIONE 116 PORTOFINO MODULAR UNIT - COMPOSITION 116	8.244
PREZZO TOTALE COMPOSIZIONE TOTAL PRICE FOR COMPOSITION		18.265	



COMPOSIZIONE 163

COMPOSITION 163

PAG. 58-59 CATALOGO "PORTOFINO" E PAG. 82-83 "PORTOFINO NEW"

PAGE 58-59 "PORTOFINO" CATALOGUE AND PAGE 82-83 "PORTOFINO NEW"

		NOCE FRASSINO	
1	PFG4021K	TAVOLO PORTOFINO RETTANGOLARE ALLUNGABILE MIS. 180/240X90 PORTOFINO EXTENDING RECTANGULAR TABLE DIM. 180/240X90	3.197
1	PFG3081K	VETRINA 2 ANTE DISPLAY UNIT WITH 2 DOORS	3.553
1	PFG2001K	CREDENZA 2 ANTE BATTENTI SIDEBOARD WITH 2 HINGED DOORS	3.411
4	CML1011K	SEDIA PENELOPE RIVESTITA IN ECOPELLE CAT.A PENELOPE CHAIR WITH ECOLEATHER COVER CAT.A	2.504
PREZZO TOTALE COMPOSIZIONE TOTAL PRICE FOR COMPOSITION		12.665	



COMPOSIZIONE 165

COMPOSITION 165

PAG. 76-77 CATALOGO "PORTOFINO" E PAG. 90-91 "PORTOFINO NEW"

PAGE 76-77 "PORTOFINO" CATALOGUE AND PAGE 90-91 "PORTOFINO NEW"

		NOCE FRASSINO	
2	PFG3081K	VETRINA 2 ANTE DISPLAY UNIT WITH 2 DOORS	7.106
1	PFG4021K	TAVOLO PORTOFINO RETTANGOLARE ALLUNGABILE MIS. 180/240X90 PORTOFINO EXTENDING RECTANGULAR TABLE DIM. 180/240X90	3.197
4	CML1011K	SEDIA PENELOPE RIVESTITA IN ECOPELLE CAT.A PENELOPE CHAIR WITH ECOLEATHER COVER CAT.A	2.504
PREZZO TOTALE COMPOSIZIONE TOTAL PRICE FOR COMPOSITION		12.807	



PORTOFINO SISTEMA COMPONIBILE

PORTOFINO MODULAR SYSTEM

CARATTERISTICHE TECNICHE E PARTICOLARITÀ DI UTILIZZO TECHNICAL CHARACTERISTICS AND PARTICULAR USE	174
ACCESSORI OPTIONAL - ELEMENTI COMUNI OPTIONAL ACCESSORIES - COMMUN ELEMENTS	180
BASI A TERRA P. 40 FLOOR-STANDING BASE UNIT D. 40	182
BASI A TERRA P. 50 FLOOR-STANDING BASE UNIT D. 50	184
BASI SOSPESE P. 40 SUSPENDED BASE UNITS D. 40	186
BASI SOSPESE P. 50 SUSPENDED BASE UNITS D. 50	188
PENSILI ORIZZONTALI P. 40 HORIZONTAL WALL UNITS D. 40	190
PENSILI VERTICALI P. 40/41 VERTICAL WALL UNITS D. 40/41	192
MADIA H. 63 P. 40/50 CUPBOARD H. 63 D. 40/50	194
VETRINE H. 208 P. 40 DISPLAY UNITS H. 208 D. 40	196
COMPOSIZIONI A CATALOGO CATALOGUE COMPOSITIONS	198

PORTOFINO SISTEMA COMPONIBILE - MODULAR SYSTEM

CARATTERISTICHE TECNICHE E PARTICOLARITÀ DI UTILIZZO

TECHNICAL CHARACTERISTICS AND PARTICULAR USE

ANTE DOORS

ANTA PER PENSILI CON CORNICE PERIMETRALE
DOOR FOR WALL UNITS WITH PERIMETRIC FRAME

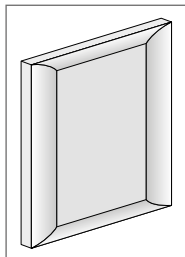

ANTA LEGNO
WOODEN DOOR

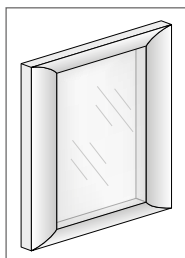

ANTA VETRO
GLASS DOOR

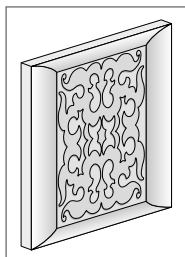

ANTA TRAFORATA
PERFORATED DOOR

ANTA PER PENSILI SENZA CORNICE PERIMETRALE
DOOR FOR WALL UNITS WITHOUT PERIMETRIC FRAME

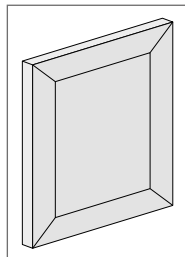

ANTA LEGNO
WOODEN DOOR

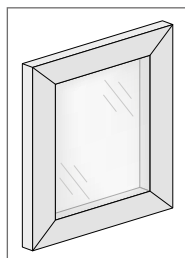

ANTA VETRO
GLASS DOOR

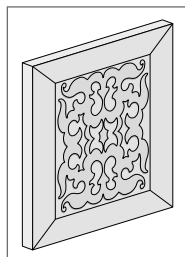

ANTA TRAFORATA
PERFORATED DOOR

ANTA LEGNO MASSELLO DI TOULUPIER O FRASSINO SPAZZOLATO SP. CM. 3 E PANNELLO IN MULTISTRATO IMPIALLACCIATO NOCE O FRASSINO SPAZZOLATO SP. CM.0.8 VERNICIATO O LACCATO A PORO APERTO.

MANIGLIA PUSH-PULL, POMOLO O CUORE IN FINITURA NICHEL LUCIDO.

CERNIERE AMMORTIZZATE DI SERIE

WOODEN DOOR TOULUPIER SOLID WOOD OR BRUSHED ASHWOOD TH. CM. 3 AND MULTILAYER PANEL VENEERED IN WALNUT OR BRUSHED ASHWOOD TH. CM.0.8 PAINTED OR OPEN PORE LACQUERED.

HANDLE PUSH-PULL, KNOB OR CUORE IN GLOSSY NICKEL FINISH.

STANDARD SOFT-CLOSE HINGES

ANTA VETRO MASSELLO DI TOULUPIER O FRASSINO SPAZZOLATO SP. CM.3 E VETRO FLOAT SPESSORE CM.0.4, VERNICIATO O LACCATO A PORO APERTO.

MANIGLIA PUSH-PULL, POMOLO O CUORE IN FINITURA NICHEL LUCIDO.

CERNIERE AMMORTIZZATE DI SERIE

GLASS DOOR TOULUPIER SOLID WOOD OR BRUSHED ASHWOOD TH. CM.3 AND FLOAT GLASS TH. CM.0.4, OPEN PORE LACQUERED OR PAINTED.

HANDLE PUSH-PULL, KNOB OR CUORE IN GLOSSY NICKEL FINISH.

STANDARD SOFT-CLOSE HINGES

ANTA TRAFORATA MASSELLO DI TOULUPIER O FRASSINO SPAZZOLATO SP. CM.3 E PANNELLO IN MULTISTRATO IMPIALLACCIATO IN NOCE O FRASSINO SPAZZOLATO SP. CM.0.8, VERNICIATO O LACCATO A PORO APERTO.

MANIGLIA PUSH-PULL, POMOLO O CUORE IN FINITURA NICHEL LUCIDO.

CERNIERE AMMORTIZZATE DI SERIE

PERFORATED DOOR TOULUPIER SOLID WOOD OR BRUSHED ASHWOOD TH. CM.3 AND MULTILAYER PANEL VENEERED IN WALNUT OR BRUSHED ASHWOOD TH. CM.0.8, OPEN PORE LACQUERED OR PAINTED.

HANDLE PUSH-PULL, KNOB OR CUORE IN GLOSSY NICKEL FINISH.

STANDARD SOFT-CLOSE HINGES

CASSETTI E CESTONI DRAWERS AND BASKETS

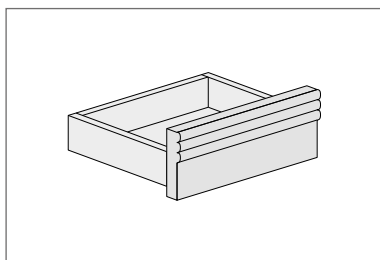

CASSETTO LEGNO
WOODEN DRAWER

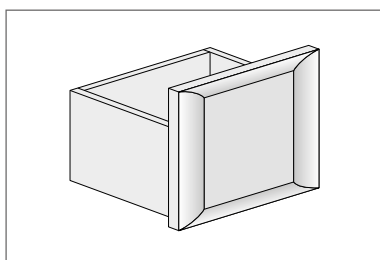

CESTONE LEGNO
WOODEN BASKET

FRONTALE CASSETTO MASSELLO DI TOULUPIER O FRASSINO SPAZZOLATO SP. CM. 3, VERNICIATO O LACCATO A PORO APERTO.

STRUTTURA CASSETTO PANNELLO DI MULTISTRATO BETULLA SP. CM. 1.5 VERNICIATO TINTA ACACIA.

GUIDE CASSETTO REGOLABILI IN ALTEZZA E CON RICHIAMO AUTOMATICO AMMORTIZZATO

MANIGLIA CASSETTO PUSH-PULL O MANIGLIA MONDRIAN IN FINITURA ABBIANATA AL CASSETTO.

DRAWER FRONT TOULUPIER SOLID WOOD OR BRUSHED SOLID ASHWOOD TH. CM. 3, OPEN PORE LACQUERED OR PAINTED.

DRAWER STRUCTURE BIRCH MULTILAYER PANEL TH. CM.1.5 ACACIA STAINED PAINTED.

DRAWER GUIDES ADJUSTABLE IN HEIGHT AND SOFT-CLOSE SELF-CLOSING MECHANISM

DRAWER HANDLE PUSH-PULL OR MONDRIAN HANDLE IN THE SAME FINISH AS THE DRAWER.

FRONTALE CESTONE PANNELLO DI LISTELLARE IMPIALLACCIATO IN NOCE O FRASSINO SPAZZOLATO O SP. CM. 1.5 E CORNICE PERIMETRALE IN MASSELLO DI TOULUPIER O FRASSINO SPAZZOLATO SP. CM.3 VERNICIATO O LACCATO A PORO APERTO.

STRUTTURA CESTONE PANNELLO DI MULTISTRATO BETULLA SP. CM.1.5 VERNICIATO TINTA ACACIA.

GUIDE CASSETTO REGOLABILI IN ALTEZZA E CON RICHIAMO AUTOMATICO AMMORTIZZATO

MANIGLIA CESTONE PUSH-PULL, POMOLO, CUORE O RABBIT IN FINITURA NICHEL LUCIDO.

BASKET FRONT BLOCKBOARD PANEL VENEERED IN WALNUT OR BRUSHED ASHWOOD TH. CM. 1.5 AND PERIMETRIC FRAME IN TOULUPIER SOLID WOOD OR BRUSHED ASHWOOD TH. CM.3 OPEN PORE LACQUERED OR PAINTED.

BASKET STRUCTURE BIRCH MULTILAYER PANEL TH. CM.1.5 ACACIA STAINED PAINTED.

DRAWER GUIDES ADJUSTABLE IN HEIGHT AND SOFT-CLOSE SELF-CLOSING MECHANISM

BASKET HANDLE PUSH-PULL, KNOB, CUORE OR RABBIT IN GLOSSY NICKEL FINISH.

PORTOFINO SISTEMA COMPONIBILE - MODULAR SYSTEM

ESEMPIO DI ELEMENTI A TERRA, IN APPOGGIO E A PARETE

EXAMPLE OF FLOOR-STANDING, RAISED AND WALL ELEMENTS

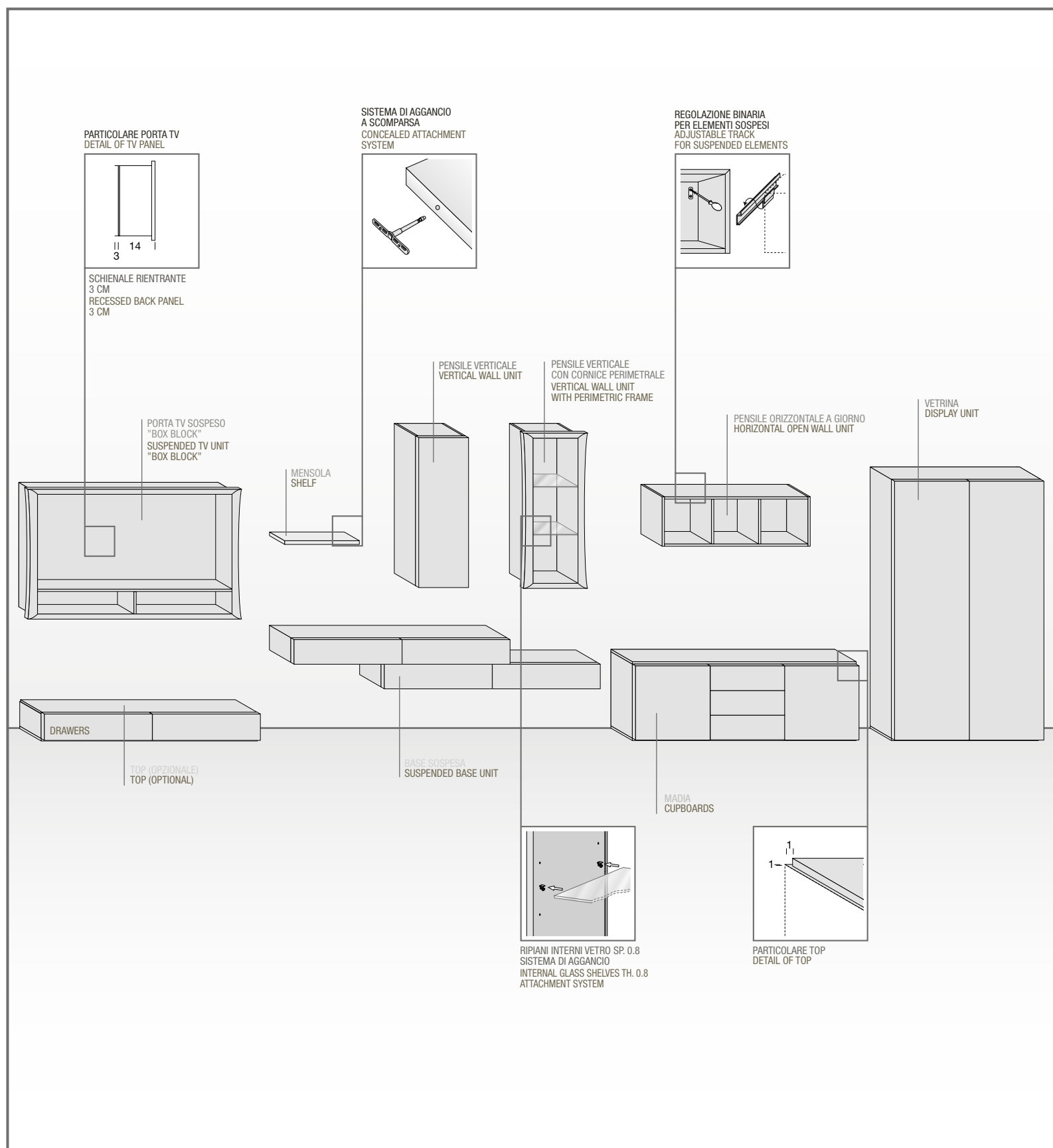

FRONTALI PORTOFINO PORTOFINO FRONTS

ANTE DOORS

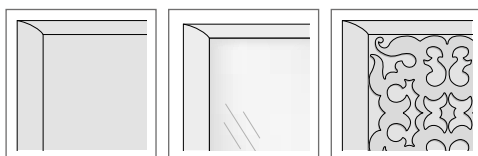

LEGNO
(BATTENTE/VASISTAS/
RIBALTA)
WOOD
(HINGED/LIFT-UP/DROP-
DOWN)

VETRO
(BATTENTE/VASISTAS/
RIBALTA)
GLASS
(HINGED/LIFT-UP/DROP-
DOWN)

TRAFORATO
(BATTENTE)
PERFORATED
(HINGED)

ANTA CON CORNICE PERIMETRALE DOOR WITH PERIMETRIC FRAME

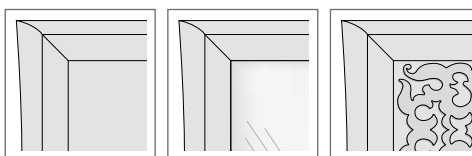

LEGNO
(BATTENTE)
WOOD
(HINGED)

VETRO
(BATTENTE)
GLASS
(HINGED)

TRAFORATO
(BATTENTE)
PERFORATED
(HINGED)

CASSETTI DRAWERS

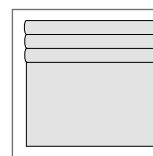

LEGNO INCISO
RIDGED WOOD

CESTONI BASKETS

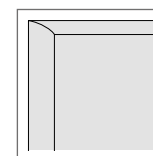

LEGNO
WOOD

PORTOFINO SISTEMA COMPONIBILE - MODULAR SYSTEM

MODULARITÀ

MODULARITY

BASI A TERRA H. 21.5 – P. 40/50

FLOOR-STANDING BASE UNIT H. 21.5 – D. 40/50

CON CASSETTO
WITH DRAWER



BASI A TERRA H. 41.5 – P. 40/50

FLOOR-STANDING BASE UNIT H. 41.5 – D. 40/50

A GIORNO
OPEN

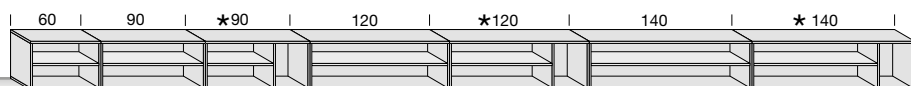

A GIORNO CON CASSETTO
OPEN WITH DRAWER

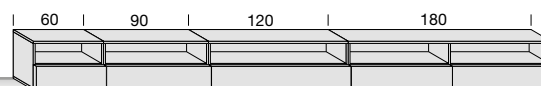

CON CASSETTI
WITH DRAWERS



CON CESTONE
WITH BASKET



CON ANTA A RIBALTA
WITH DROP-DOWN DOOR

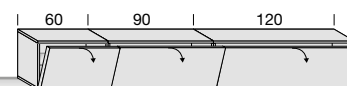

BASI A TERRA H. 41.5 – P. 40/50

FLOOR-STANDING BASE UNIT H. 41.5 – D. 40/50

CON ANTA
WITH DOOR

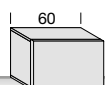

CON ANTA
WITH DOOR

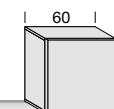

BASI SOSPESE H. 20 – P. 40/50

SUSPENDED BASE UNITS H. 20 – D. 40/50

CON CASSETTO
WITH DRAWER



BASI SOSPESE H. 40 – P. 40/50

SUSPENDED BASE UNITS H. 40 – D. 40/50

A GIORNO
OPEN

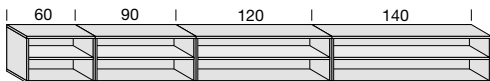

CON CESTONE
WITH BASKET

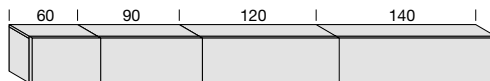

CON ANTA A RIBALTA
WITH DROP-DOWN DOOR

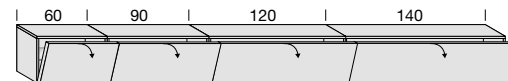

PENSILI ORIZZONTALI H. 20 – P. 40

HORIZONTAL WALL UNITS H. 20 – D. 40

A GIORNO
OPEN

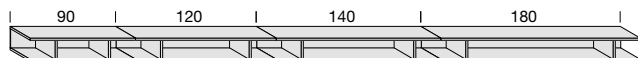

MODULARITÀ MODULARITY

■ ELEMENTI ANCHE CON CORNICE PERIMETRALE
ELEMENTS ALSO WITH PERIMETRIC FRAME

PENSILI ORIZZONTALI H. 40 – P. 40 HORIZONTAL WALL UNITS H. 40 – D. 40

A GIORNO
OPEN

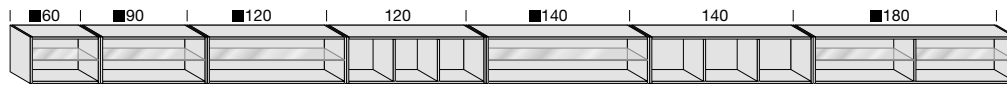

CON ANTA A RIBALTA/VASISTAS
WITH DROP-DOWN/LIFT-UP DOOR

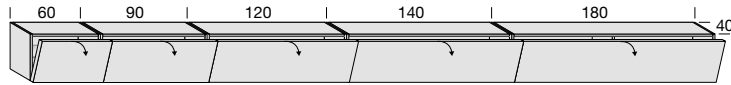

CON ANTA A RIBALTA
WITH DROP-DOWN DOOR

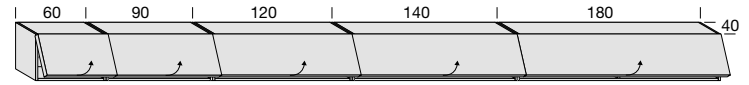

PENSILI ORIZZONTALI H. 60/64.4 – P. 40 HORIZONTAL WALL UNITS H. 60/64.4 – D. 40

A GIORNO
OPEN

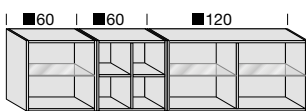

CON ANTA
WITH DOOR

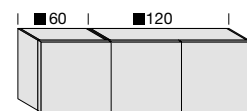

PENSILI VERTICALI H. 120/124.4 – P. 40/41 VERTICAL WALL UNITS H. 120/124.4 – D. 40/41

A GIORNO
OPEN

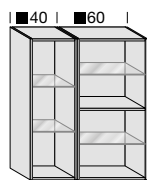

CON ANTA
WITH DOOR

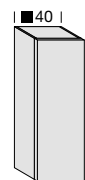

CON ANTE
WITH DOORS

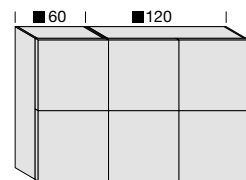

MADIE H. 63/130 – P. 40/50 CUPBOARDS H. 63 – D. 40/50

CON ANTA E CASSETTI
WITH DOOR AND DRAWERS

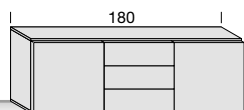

CON ANTE
WITH DOORS

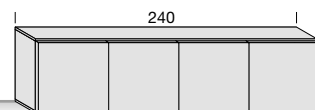

CON ANTE
WITH DOORS

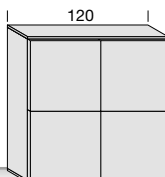

VETRINE H. 208 – P. 40 DISPLAY UNITS H. 208 – D. 40

CON ANTE
WITH DOORS

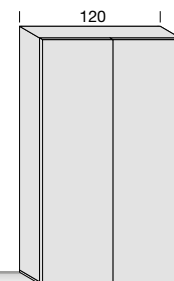

PORTA TV "BOX BLOCK" H. 100 – P. 21 CON CORNICE PERIMETRALE "BOX BLOCK" TV UNIT H. 100 – D. 21 WITH PERIMETRIC FRAME

CON VANO PORTA DECODER
WITH DECODER UNIT

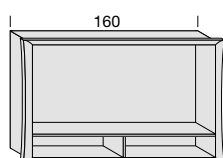

CON LIBRERIA SX
WITH LH BOOKCASE

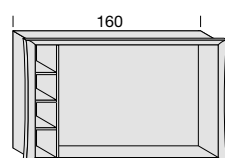

CON LIBRERIA DX
WITH RH BOOKCASE

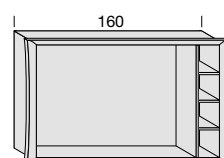

PORTOFINO SISTEMA COMPONIBILE - MODULAR SYSTEM

CARATTERISTICHE TECNICHE E PARTICOLARITÀ DI UTILIZZO

TECHNICAL CHARACTERISTICS AND PARTICULAR USE

LIMITI DI UTILIZZO PER PENSILI VASISTAS E RIBALTA

USE LIMITS FOR WALL UNITS WITH LIFT-UP DOORS AND DROP-DOWN DOORS

PORTOFINO:

NON È POSSIBILE SOVRAPPORRE DUE PENSILI VASISTAS O DUE PENSILI RIBALTA

PORTOFINO:

IT IS NOT POSSIBLE TO STACK TWO ALL UNITS WITH LIFT-UP DOORS OR TWO WALL UNITS WITH DROP-DOWN DOORS

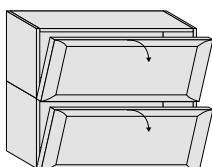
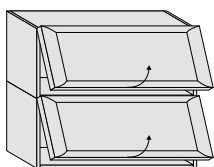

ALTEZZE MASSIME DI POSIZIONAMENTO ANTE VASISTAS/RIBALTA

MAXIMUM POSITION HEIGHTS FOR LIFT-UP/DROP-DOWN DOORS

ANTA VASISTAS LIFT-UP DOOR

H.250

H.160

H.108

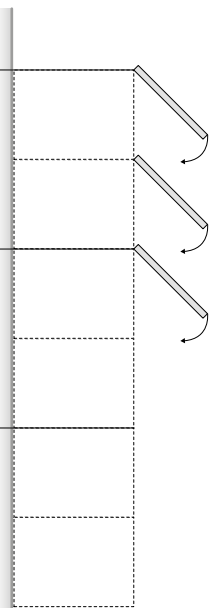

ANTA RIBALTA DROP-DOWN DOOR

H.250

H.160

H.108

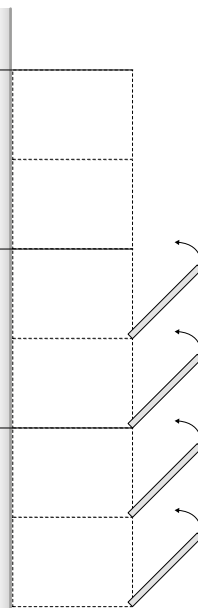

POSIZIONAMENTO ANTE A VASISTAS DA H. 160 A H. 250
POSITION OF LIFT-UP DOORS FROM H. 160 TO H. 250

POSIZIONAMENTO ANTE A RIBALTA DA H. 4.5 A H. 160
POSITION OF DROP-DOWN DOORS H. 4.5 A H. 160

CARATTERISTICHE TECNICHE E PARTICOLARITÀ DI UTILIZZO TECHNICAL CHARACTERISTICS AND PARTICULAR USE

GESTIONE CORNICE PERIMETRALE PERIMETRIC FRAME

INGOMBRI CORNICE PERIMETRALE DIMENSIONS FOR PERIMETRIC FRAME

VISTA FRONTALE
FRONT VIEW

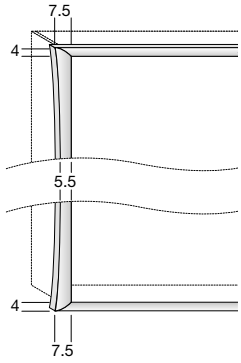

VISTA IN PIANTA
LAYOUT VIEW

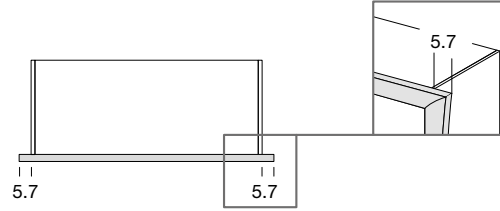

VISTA LATERALE
SIDE VIEW

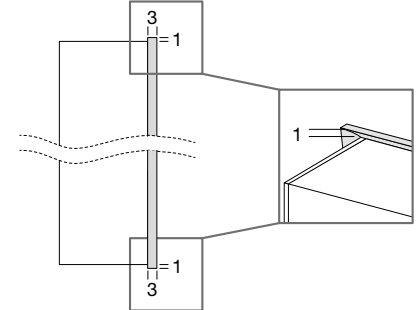

PENSILI SENZA CORNICE PERIMETRALE PORTOFINO WALL UNITS WITHOUT PORTOFINO PERIMETRIC FRAME

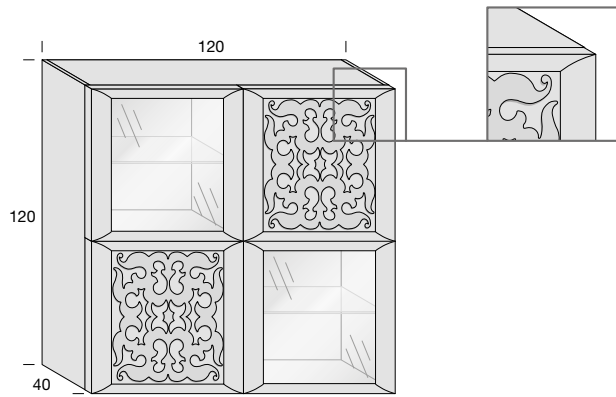

PENSILI CON CORNICE PERIMETRALE PORTOFINO E CROCIERA A VISTA WALL UNITS WITH PORTOFINO PERIMETRIC FRAME AND VISIBLE CROSSPIECE

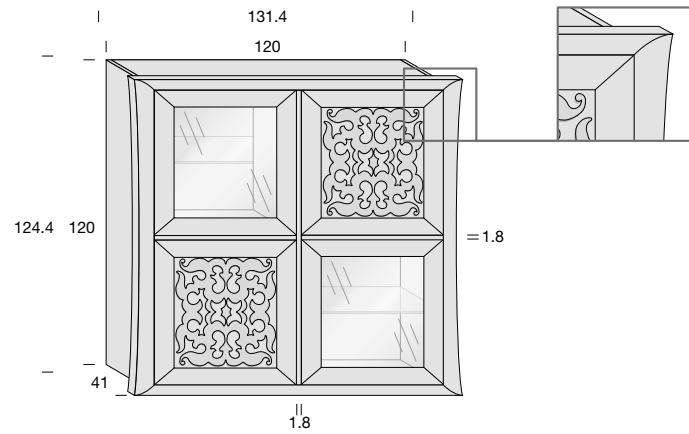

GESTIONE CORNICE PER BASI A GIORNO FRAME FOR OPEN BASE UNITS

BASI SENZA CORNICE DECOR CON RIPIANO LEGNO BASE UNITS WITHOUT DECOR FRAME WITH WOODEN SHELF

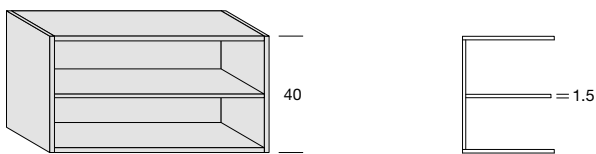

BASI SENZA CORNICE PORTOFINO CON RIPIANO VETRO BASE UNITS WITHOUT PORTOFINO FRAME WITH GLASS SHELF

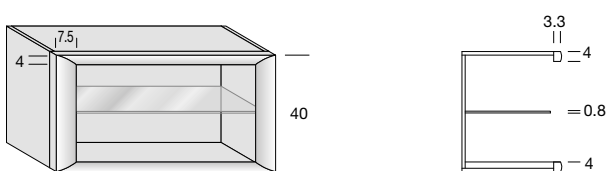

PORTOFINO SISTEMA COMPONIBILE - MODULAR SYSTEM

ACCESSORI OPTIONAL - ELEMENTI COMUNI

OPTIONAL ACCESSORIES - COMMUN ELEMENTS

BARRA LED A BASSO CONSUMO
ACCENSIONE TOUCH
IN ALLUMINIO L. 37.2
COLLEGAMENTO
A CARICO DEL CLIENTE

LOW CONSUMPTION LED BAR
TOUCH SWITCH
IN ALUMINIUM W. 37.2
CONNECTIONS
TO BE MADE BY THE CUSTOMER.



codice
code

ZZZFE22001

163

TELECOMANDO
REMOTE CONTROL



codice
code

ZZZFE22004

158

ALIMENTATORE
POWER SUPPLY



codice
code

ZZZFE22002

67

KIT SPORTELLINO PASSACAVI
+ BORCHIA

KIT FOR CABLE MANAGEMENT HOLE
+ COVER

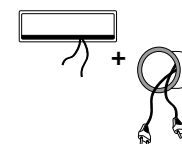

codice
code

ZZZFE22005

133

MULTIPRESA A SCOMPARSA CON
SPORTELLINO APRI/CHIUDI IN
METALLO

CONCEALED MULTIPLE SOCKET
WITH METAL OPEN/CLOSE FLAP

VERSIONE TV:
 1 PRESA SCHUKO
 2 PRESA USB RICARICA
 1 PRESA SAT.
 TV VERSION:
 1 SCHUKO SOCKET
 2 SOCKETS USB CHARGE
 1 SAT. SOCKET



codice
code

ZZZFE22030

595

VERSIONE PC/MAC:
 1 PRESA SCHUKO
 2 PORTE USB DATI
 1 PORTA HDMI
 PC/MAC VERSION:
 1 SCHUKO SOCKET
 2 USB PORT
 1 HDMI PORT



codice
code

ZZZFE22031

595

MENSOLE P. 28 – SP. 3
SHELVES D. 28 – TH. 3

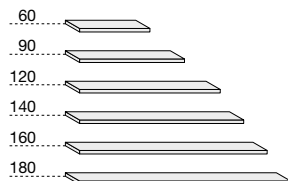

larghezza width	codice code	NOCE-FRASSINO WALNUT-ASHWOOD	
60	PFC3501K	187	mc 0,02 – Kg 2
90	PFC3511K	229	mc 0,03 – Kg 3
120	PFC3521K	271	mc 0,03 – Kg 6
140	PFC3541K	308	mc 0,04 – Kg 9
160	PFC3551K	361	mc 0,05 – Kg 9
180	PFC3531K	386	mc 0,05 – Kg 9

MENSOLONE P. 50 – SP. 6
POSIZIONABILI MAX H. 1,2 METRI.
PER AUTOPORTANTE
AGGIUNGERE STAFFE DA MURO
(+ 50,00 €)

LARGE SHELF D. 50 – TH. 6
1,2 METER MAX ADJUSTABLE.
FOR SELF-SUPPORTING
ADD WALL BRACKETS
(+ 50,00 €)

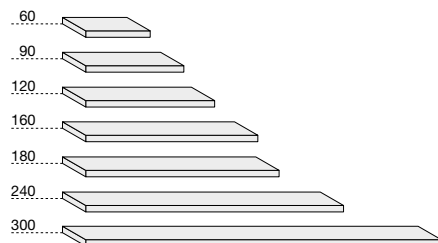

larghezza width	codice code	NOCE-FRASSINO WALNUT-ASHWOOD	
60	DCC3001K	223	mc 0,03 – Kg 3
90	DCC3011K	318	mc 0,03 – Kg 4
120	DCC3021K	415	mc 0,05 – Kg 7
160	DCC3061K	511	mc 0,06 – Kg 10
180	DCC3031K	554	mc 0,07 – Kg 10
240	DCC3041K	758	mc 0,09 – Kg 14
300	DCC3071K	890	mc 0,10 – Kg 16

PORTA TV SOSPESO
"BOX BLOCK" P. 21 – H. 100
SUSPENDED TV UNIT
"BOX BLOCK" D. 21 – H. 100

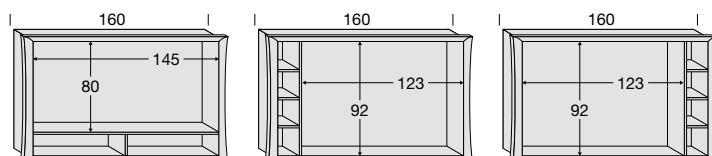

CON PORTA DECODER
 WITH DECODER UNIT

CON LIBRERIA A SX
 WITH LH BOOKCASE

CON LIBRERIA A DX
 WITH RH BOOKCASE

larghezza width	codice code	NOCE-FRASSINO WALNUT-ASHWOOD	
160	PFC8021K	1.552	mc 1,5 – Kg 22
CON PORTA DECODER WITH DECODER UNIT			
160	PFC8001K	1.882	mc 1,5 – Kg 22
CON LIBRERIA A SX WITH LH BOOKCASE			
160	PFC8011K	1.882	mc 1,5 – Kg 22
CON LIBRERIA A DX WITH RH BOOKCASE			

ELEMENTI COMUNI COMMUN ELEMENTS

PORTA DECODER ZOE P. 40 – H. 14 ZOE DECODER UNIT D. 40 – H. 14

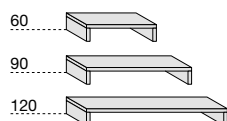

larghezza width	codice code	NOCE-FRASSINO WALNUT-ASHWOOD	
60	PFC3161K	259	mc 0,06 – Kg 7
90	PFC3111K	278	mc 0,08 – Kg 9
120	PFC3121K	331	mc 0,11 – Kg 11

PORTA DECODER ZOE P. 50 – H. 14 ZOE DECODER UNIT D. 50 – H. 14

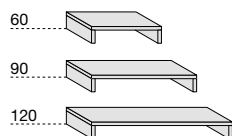

larghezza width	codice code	NOCE-FRASSINO WALNUT-ASHWOOD	
60	PFC3131K	265	mc 0,07 – Kg 7
90	PFC3141K	301	mc 0,10 – Kg 9
120	PFC3151K	349	mc 0,13 – Kg 11

PIEDISTALLI PER MENSOLONI P. 50 SP. 6 PEDESTAL FOR LARGE SHELVES D. 50 TH. 6



altezza height	codice code	NOCE-FRASSINO WALNUT-ASHWOOD	
41.5	DCC3511K	247	mc 0,02 – Kg 2
61.5	DCC3501K	271	mc 0,03 – Kg 3

TOP P. 40 PER BASI (OPZIONALE) P. 40 – SP. 1.5 BASE UNITS TOP D. 40 (OPTIONAL) D. 40 – TH. 1.5

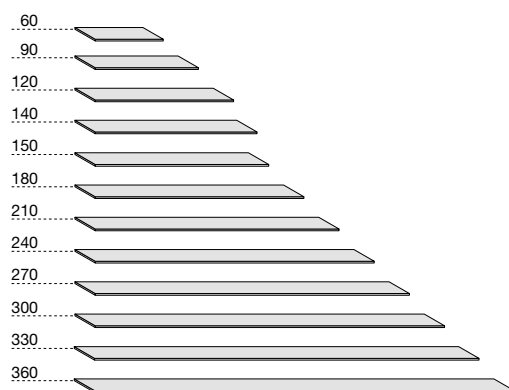

larghezza width	codice code	NOCE-FRASSINO WALNUT-ASHWOOD	
60	PFC5001C	133	mc 0,01 – Kg 3
90	PFC5011C	163	mc 0,02 – Kg 3,5
120	PFC5021C	181	mc 0,02 – Kg 4
140	PFC5221C	193	mc 0,03 – Kg 4,5
150	PFC5031C	206	mc 0,3 – Kg 6
180	PFC5041C	235	mc 0,04 – Kg 7
210	PFC5051C	265	mc 0,05 – Kg 8
240	PFC5061C	301	mc 0,05 – Kg 9
270	PFC5071C	318	mc 0,06 – Kg 9
300	PFC5081C	349	mc 0,06 – Kg 10
330	PFC5211C	391	mc 0,07 – Kg 10
360	PFC5091C	409	mc 0,07 – Kg 12

TOP P. 50 PER BASI (OPZIONALE) P. 50 – SP. 1.5 BASE UNITS TOP D. 50 (OPTIONAL) D. 50 – TH. 1.5

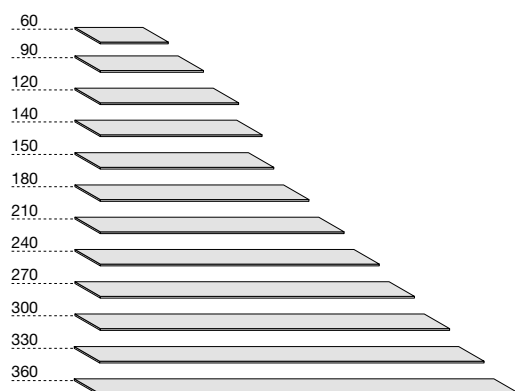

larghezza width	codice code	NOCE-FRASSINO WALNUT-ASHWOOD	
60	PFC5101C	150	mc 0,01 – Kg 3
90	PFC5111C	175	mc 0,02 – Kg 3,5
120	PFC5121C	206	mc 0,02 – Kg 4
140	PFC5231C	223	mc 0,03 – Kg 4,5
150	PFC5131C	241	mc 0,3 – Kg 6
180	PFC5141C	271	mc 0,04 – Kg 7
210	PFC5151C	301	mc 0,05 – Kg 8
240	PFC5161C	349	mc 0,05 – Kg 9
270	PFC5171C	391	mc 0,06 – Kg 9
300	PFC5181C	415	mc 0,06 – Kg 10
330	PFC5201C	463	mc 0,07 – Kg 10
360	PFC5191C	481	mc 0,07 – Kg 12

PORTOFINO SISTEMA COMPONIBILE - MODULAR SYSTEM

BASI A TERRA P. 40

FLOOR-STANDING BASE UNIT D. 40

BASI H. 21.5

BASE UNITS H. 21.5

1 CASSETTO
1 DRAWER

1 CASSETTO
1 DRAWER

1 CASSETTO
1 DRAWER

1 CASSETTO
1 DRAWER

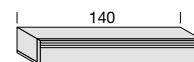
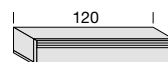
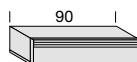
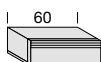

PFC1011K

PFC1031K

PFC1051K

PFC1054K

NOCE-FRASSINO / WALNUT-ASHWOOD

764

879

1.107

1.257

mc 0,06 – Kg 14

mc 0,09 – Kg 18

mc 0,13 – Kg 22

mc 0,15 – Kg 25

BASI H. 41.5

BASE UNITS H. 41.5

A GIORNO, 1 RIPIANO VETRO
OPEN, 1 GLASS SHELF

A GIORNO, 1 CASSETTO
OPEN, 1 DRAWER

2 CASSETTI
2 DRAWERS

1 CESTONE
1 BASKET

1 ANTA LEGNO, 1 RIPIANO VETRO
1 WOODEN DROP-DOWN DOOR, 1 GLASS SHELF

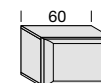
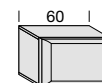
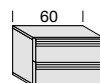
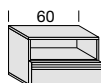
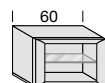

DX / RH
SX / LH

PFC1091K

PFC1152K

PFC1153K

PFC1151K

PFC1901K
PFC1911K

NOCE-FRASSINO / WALNUT-ASHWOOD

703

1.034

1.318

909

831

mc 0,12 – Kg 12

mc 0,12 – Kg 17

mc 0,12 – Kg 18

mc 0,12 – Kg 17

mc 0,12 – Kg 15

1 CESTONE
1 BASKET

1 RIBALTA LEGNO, 1 RIPIANO VETRO
1 WOODEN DROP-DOWN DOOR, 1 GLASS SHELF

A GIORNO, 1 RIPIANO VETRO
OPEN, 1 GLASS SHELF

A GIORNO, 1 CASSETTO
OPEN, 1 DRAWER

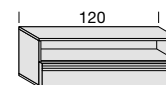
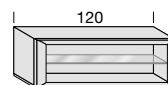
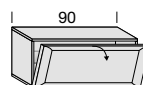
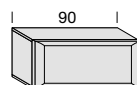

PFC1171K

PFC3311K

PFC1131K

PFC1382K

NOCE-FRASSINO / WALNUT-ASHWOOD

1.130

1.130

1.052

1.240

mc 0,18 – Kg 25

mc 0,18 – Kg 24

mc 0,24 – Kg 25

mc 0,24 – Kg 34

A GIORNO, 1 CASSETTO
OPEN, 1 DRAWER

2 CASSETTI
2 DRAWERS

1 CESTONE
1 BASKET

1 RIBALTA LEGNO, 1 RIPIANO VETRO
1 WOODEN DROP-DOWN DOOR, 1 GLASS SHELF

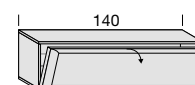
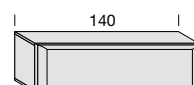
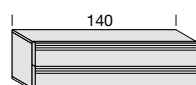
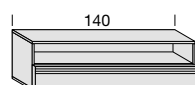

PFC1384K

PFC1364K

PFC1194K

PFC3324K

NOCE-FRASSINO / WALNUT-ASHWOOD

1.504

1.780

1.593

1.593

mc 0,28 – Kg 40

mc 0,28 – Kg 41

mc 0,28 – Kg 39

mc 0,28 – Kg 38

2 CASSETTI
2 DRAWERS

BASI AD ANGOLO H. 41.5
CORNER BASE UNITS H. 41.5

ANGOLO CIECO 43 x 43
BLIND CORNER BASE 43 x 43

ANGOLO, 1 ANTA
CORNER BASE, 1 DOOR

NEW

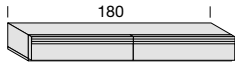

PFC1071K

1.582

mc 0,16 – Kg 50



PFC1961K

577

mc 0,09 – Kg 11

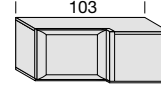

PFC1971K
PFC1981K

1.745

mc 0,22 – Kg 25

DX / RH
SX / LH

OPTIONAL
OPTIONAL

KIT SPORTELLI PASSACAVI
+ BORCHIA
KIT FOR CABLE MANAGEMENT HOLE
+ COVER

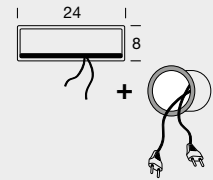

ZZZFE22005

133

1 RIBALTA LEGNO, 1 RIPIANO VETRO
1 WOODEN DROP-DOWN DOOR, 1 GLASS SHELF

A GIORNO, 1 RIPIANO VETRO
OPEN, 1 GLASS SHELF

A GIORNO, 1 CASSETTO
OPEN, 1 DRAWER

2 CASSETTI
2 DRAWERS

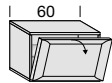

PFC3101K

909

mc 0,12 – Kg 16

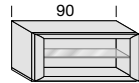

PFC1111K

848

mc 0,18 – Kg 18

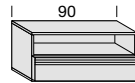

PFC1362K

1.136

mc 0,18 – Kg 26

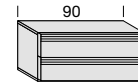

PFC1173K

1.425

mc 0,18 – Kg 27

KIT PIEDI INTAGLIATI H. 15 CM
KIT FOR CARVED FEET H. 15 CM

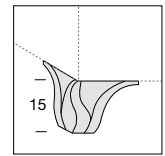

ACS4001K

278

2 CASSETTI
2 DRAWERS

1 CESTONE
1 BASKET

1 RIBALTA LEGNO, 1 RIPIANO VETRO
1 WOODEN DROP-DOWN DOOR, 1 GLASS SHELF

A GIORNO, 1 RIPIANO VETRO
OPEN, 1 GLASS SHELF

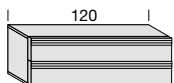

PFC1383K

1.521

mc 0,24 – Kg 35

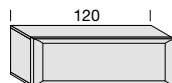

PFC1191K

1.323

mc 0,24 – Kg 33

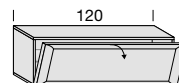

PFC3321K

1.323

mc 0,24 – Kg 32

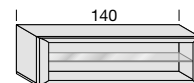

PFC1134K

1.270

mc 0,28 – Kg 28

A GIORNO, 2 CASSETTI
OPEN, 2 DRAWERS

4 CASSETTI
4 DRAWERS

BASI H. 61.5
BASE UNITS
H. 61.5

1 ANTA LEGNO, 1 RIPIANO VETRO
1 WOODEN DOOR, 1 GLASS SHELF

1 ANTA TRAFORATA, 1 RIPIANO VETRO
1 PERFORATED DOOR, 1 GLASS SHELF



PFC3192K

1.816

mc 0,36 – Kg 52

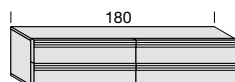

PFC3193K

2.153

mc 0,36 – Kg 54

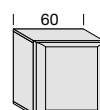

DX / RH
SX / LH

PFC3331K
PFC3332K

975

mc 0,18 – Kg 23

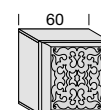

PFC3335K
PFC3336K

1.136

mc 0,18 – Kg 23

POSSIBILITÀ DI FRONTALE DIVERSO
DALLA SCOCCA, SPECIFICARE LA
FINITURA SCELTA

IN CASE OF FRONT DIFFERENT FROM
THE CARCASE CONSIDER THE
HIGHER PRICE OF THE CHOSEN
FINISH

PORTOFINO SISTEMA COMPONIBILE - MODULAR SYSTEM

BASI A TERRA P. 50

FLOOR-STANDING BASE UNIT D. 50

BASI H. 21.5

BASE UNITS H. 21.5

1 CASSETTO
1 DRAWER

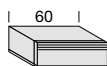

PFC1001K

NOCE-FRASSINO / WALNUT-ASHWOOD

788

mc 0,07 – Kg 18

1 CASSETTO
1 DRAWER

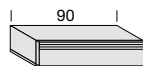

PFC1021K

903

mc 0,11 – Kg 15

1 CASSETTO
1 DRAWER

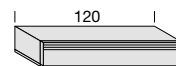

PFC1041K

1.143

mc 0,15 – Kg 28

1 CASSETTO
1 DRAWER

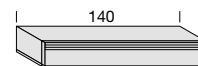

PFC1044K

1.311

mc 0,18 – Kg 32

BASI H. 41.5

BASE UNITS H. 41.5

A GIORNO, 1 RIPIANO VETRO
OPEN, 1 GLASS SHELF

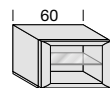

DX / RH
SX / LH

PFC1081K

727

mc 0,15 – Kg 15

A GIORNO, 1 CASSETTO
OPEN, 1 DRAWER

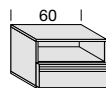

PFC1142K

1.059

mc 0,15 – Kg 22

2 CASSETTI
2 DRAWERS

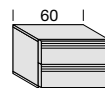

PFC1143K

1.353

mc 0,15 – Kg 23

1 CESTONE
1 BASKET

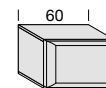

PFC1141K

932

mc 0,15 – Kg 22

1 ANTA LEGNO, 1 RIPIANO VETRO
1 WOODEN DOOR, 1 GLASS SHELF

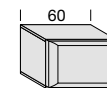

PFC1921K
PFC1931K

861

mc 0,15 – Kg 20

NOCE-FRASSINO / WALNUT-ASHWOOD

1 CESTONE
1 BASKET

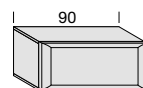

PFC1161K

1.160

mc 0,22 – Kg 32

1 RIBALTA LEGNO, 1 RIPIANO VETRO
1 WOODEN DROP-DOWN DOOR, 1 GLASS SHELF

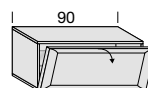

PFC3112K

1.160

mc 0,22 – Kg 30

A GIORNO, 1 RIPIANO VETRO
OPEN, 1 GLASS SHELF

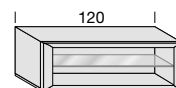

PFC1121K

1.089

mc 0,29 – Kg 32

A GIORNO, 1 CASSETTO
OPEN, 1 DRAWER

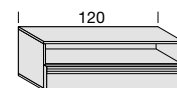

PFC1182K

1.275

mc 0,29 – Kg 42

NOCE-FRASSINO / WALNUT-ASHWOOD

A GIORNO, 1 CASSETTO
OPEN, 1 DRAWER

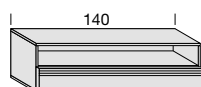

PFC1144K

1.557

mc 0,35 – Kg 50

2 CASSETTI
2 DRAWERS

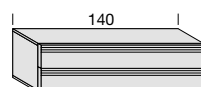

PFC1164K

1.833

mc 0,35 – Kg 52

1 CESTONE
1 BASKET

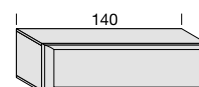

PFC1184K

1.659

mc 0,35 – Kg 49

1 RIBALTA LEGNO, 1 RIPIANO VETRO
1 WOODEN DROP-DOWN DOOR, 1 GLASS SHELF

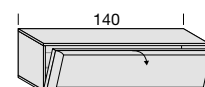

PFC3124K

1.659

mc 0,35 – Kg 48

NOCE-FRASSINO / WALNUT-ASHWOOD

2 CASSETTI
2 DRAWERS

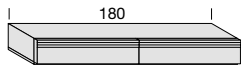

PFC1061K

1.630

mc 0,23 – Kg 23

BASI AD ANGOLO H. 41.5
CORNER BASE UNITS H. 41.5

NEW

ANGOLO CIECO 53 x 53
BLIND CORNER BASE 53 x 53



DX / RH
SX / LH

PFC1963K

625

mc 0,14 – Kg 12

ANGOLO, 1 ANTA
CORNER BASE, 1 DOOR

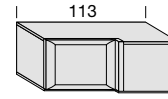

PFC1973K
PFC1974K

1.793

mc 0,30 – Kg 26

1 RIBALTA LEGNO, 1 RIPIANO VETRO
1 WOODEN DROP-DOWN DOOR, 1 GLASS SHELF

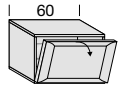

PFC3102K

932

mc 0,15 – Kg 20

A GIORNO, 1 RIPIANO VETRO
OPEN, 1 GLASS SHELF

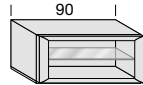

PFC1101K

871

mc 0,22 – Kg 23

A GIORNO, 1 CASSETTO
OPEN, 1 DRAWER

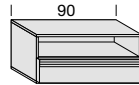

PFC1162K

1.167

mc 0,22 – Kg 33

2 CASSETTI
2 DRAWERS

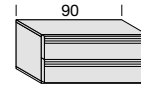

PFC1163K

1.467

mc 0,22 – Kg 34

2 CASSETTI
2 DRAWERS

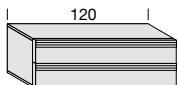

PFC1183K

1.564

mc 0,29 – Kg 43

1 CESTONE
1 BASKET



PFC1181K

1.365

mc 0,29 – Kg 41

1 RIBALTA LEGNO, 1 RIPIANO VETRO
1 WOODEN DROP-DOWN DOOR, 1 GLASS SHELF

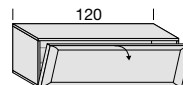

PFC3122K

1.365

mc 0,29 – Kg 40

A GIORNO, 1 RIPIANO VETRO
OPEN, 1 GLASS SHELF

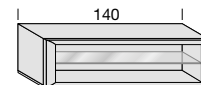

PFC1124K

1.341

mc 0,35 – Kg 35

A GIORNO, 2 CASSETTI
OPEN, 2 DRAWERS

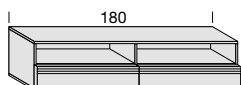

PFC1192K

1.858

mc 0,44 – Kg 65

4 CASSETTI
4 DRAWERS

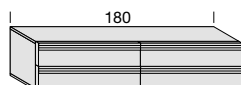

PFC1193K

2.212

mc 0,44 – Kg 68

BASI H. 61.5
BASE UNITS
H. 61.5

1 ANTA LEGNO, 1 RIPIANO VETRO
1 WOODEN DOOR, 1 GLASS SHELF

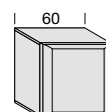

DX / RH
SX / LH

PFC3231K
PFC3232K

1.004

mc 0,22 – Kg 29

1 ANTA TRAFORATA, 1 RIPIANO VETRO
1 PERFORATED DOOR, 1 GLASS SHELF

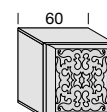

PFC3235K
PFC3236K

1.167

mc 0,22 – Kg 29

OPTIONAL
OPTIONAL

KIT SPORTELLI PASSACAVI
+ BORCHIA
KIT FOR CABLE MANAGEMENT HOLE
+ COVER

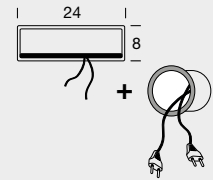

ZZZFE22005

133

KIT PIEDI INTAGLIATI H. 15 CM
KIT FOR CARVED FEET H. 15 CM

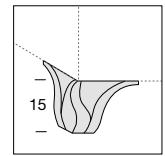

ACS4001K

278

POSSIBILITÀ DI FRONTALE DIVERSO
DALLA SCOCCA, SPECIFICARE LA
FINITURA SCELTA

IN CASE OF FRONT DIFFERENT FROM
THE CARCASE CONSIDER THE
HIGHER PRICE OF THE CHOSEN
FINISH

PORTOFINO SISTEMA COMPONIBILE - MODULAR SYSTEM

BASI SOSPESSE P. 40

SUSPENDED BASE UNITS D. 40

BASI H. 20
BASE UNIT H. 20

1 CASSETTO
1 DRAWER

1 CASSETTO
1 DRAWER

1 CASSETTO
1 DRAWER

1 CASSETTO
1 DRAWER

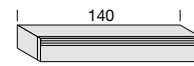
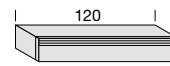
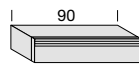
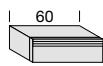

PFC1261K

PFC1281K

PFC1301K

PFC1304K

NOCE-FRASSINO / WALNUT-ASHWOOD

764

879

1.077

1.257

mc 0,06 – Kg 14

mc 0,09 – Kg 18

mc 0,13 – Kg 22

mc 0,15 – Kg 25

BASI H. 40
BASE UNITS H. 40

A GIORNO, 1 RIPIANO VETRO
OPEN, 1 GLASS SHELF

1 CESTONE
1 BASKET

1 RIBALTA LEGNO, 1 RIPIANO VETRO
1 WOODEN DROP-DOWN DOOR, 1 GLASS SHELF

A GIORNO, 1 RIPIANO VETRO
OPEN, 1 GLASS SHELF

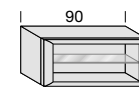
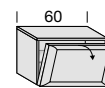
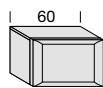
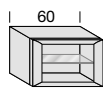

PFC1341K

PFC1401K

PFC1402K

PFC1361K

NOCE-FRASSINO / WALNUT-ASHWOOD

703

909

909

848

mc 0,12 – Kg 12

mc 0,12 – Kg 17

mc 0,12 – Kg 16

mc 0,18 – Kg 18

1 RIBALTA LEGNO
1 WOODEN DROP-DOWN DOOR

A GIORNO, 1 RIPIANO VETRO
OPEN, 1 GLASS SHELF

1 CESTONE
1 BASKET

1 RIBALTA LEGNO, 1 RIPIANO VETRO
1 WOODEN DROP-DOWN DOOR, 1 GLASS SHELF

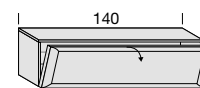
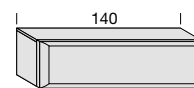
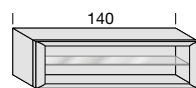
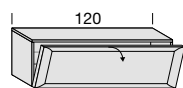

PFC1442K

PFC1324K

PFC1444K

PFC1334K

NOCE-FRASSINO / WALNUT-ASHWOOD

1.323

1.270

1.593

1.593

mc 0,24 – Kg 32

mc 0,28 – Kg 28

mc 0,28 – Kg 39

mc 0,28 – Kg 38

2 CASSETTI
2 DRAWERS

BASI AD ANGOLO H. 40
CORNER BASE UNITS H. 40

NEW

ANGOLO CIECO 43 x 43
BLIND CORNER BASE 43 x 43

ANGOLO, 1 ANTA
CORNER BASE, 1 DOOR

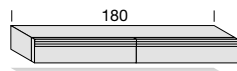

PFC1321K

1.582

mc 0,16 - Kg 50



PFC1965K

577

mc 0,09 - Kg 11

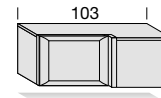

PFC1975K
PFC1976K

1.745

mc 0,22 - Kg 25

1 CESTONE
1 BASKET

1 RIBALTA LEGNO, 1 RIPIANO VETRO
1 WOODEN DROP-DOWN DOOR, 1 GLASS SHELF

A GIORNO, 1 RIPIANO VETRO
OPEN, 1 GLASS SHELF

1 CESTONE
1 BASKET

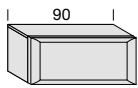

PFC1421K

1.130

mc 0,18 - Kg 25

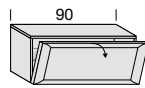

PFC1422K

1.130

mc 0,18 - Kg 24

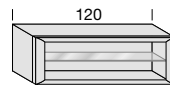

PFC1381K

1.052

mc 0,24 - Kg 25

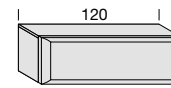

PFC1441K

1.323

mc 0,24 - Kg 33

OPTIONAL
OPTIONAL

KIT SPORTELLINO PASSACAVI
+ BORCHIA
KIT FOR CABLE MANAGEMENT HOLE
+ COVER

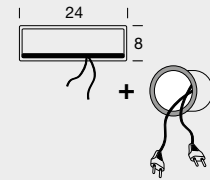

ZZZFE22005

133

KIT PIEDI INTAGLIATI H. 15 CM
KIT FOR CARVED FEET H. 15 CM

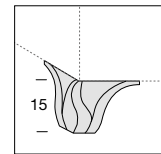

ACS4001K

278

POSSIBILITÀ DI FRONTALE DIVERSO
DALLA SCOCCA, SPECIFICARE LA
FINITURA SCELTA

IN CASE OF FRONT DIFFERENT FROM
THE CARCASE CONSIDER THE
HIGHER PRICE OF THE CHOSEN
FINISH

PORTOFINO SISTEMA COMPONIBILE - MODULAR SYSTEM

BASI SOSPESSE P. 50

SUSPENDED BASE UNITS D. 50

BASI H. 20 BASE UNIT H. 20

1 CASSETTO
1 DRAWER

1 CASSETTO
1 DRAWER

1 CASSETTO
1 DRAWER

1 CASSETTO
1 DRAWER

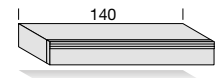
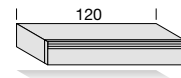
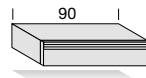
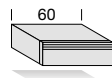

PFC1271K

PFC1291K

PFC1311K

PFC1314K

NOCE-FRASSINO / WALNUT-ASHWOOD

788

903

1.143

1.311

mc 0,07 – Kg 18

mc 0,11 – Kg 15

mc 0,15 – Kg 28

mc 0,18 – Kg 32

BASI H. 40 BASE UNITS H. 40

A GIORNO, 1 RIPIANO VETRO
OPEN, 1 GLASS SHELF

1 CESTONE
1 BASKET

1 RIBALTA LEGNO, 1 RIPIANO VETRO
1 WOODEN DROP-DOWN DOOR, 1 GLASS SHELF

A GIORNO, 1 RIPIANO VETRO
OPEN, 1 GLASS SHELF

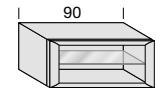
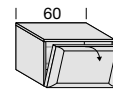
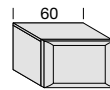
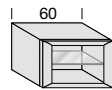

PFC1351K

PFC1411K

PFC1412K

PFC1371K

NOCE-FRASSINO / WALNUT-ASHWOOD

727

932

932

871

mc 0,15 – Kg 15

mc 0,15 – Kg 22

mc 0,15 – Kg 20

mc 0,22 – Kg 23

1 RIBALTA LEGNO, 1 RIPIANO VETRO
1 WOODEN DROP-DOWN DOOR, 1 GLASS SHELF

A GIORNO, 1 RIPIANO VETRO
OPEN, 1 GLASS SHELF

1 CESTONE
1 BASKET

1 RIBALTA LEGNO, 1 RIPIANO VETRO
1 WOODEN DROP-DOWN DOOR, 1 GLASS SHELF

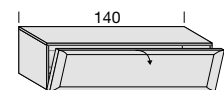
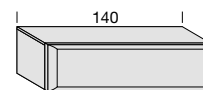
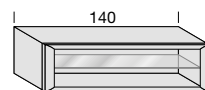
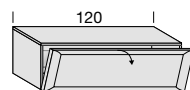

PFC1452K

PFC1394K

PFC1454K

PFC1404K

NOCE-FRASSINO / WALNUT-ASHWOOD

1.365

1.341

1.648

1.648

mc 0,29 – Kg 40

mc 0,35 – Kg 35

mc 0,35 – Kg 49

mc 0,35 – Kg 48

2 CASSETTI
2 DRAWERS

BASI AD ANGOLO H. 40
CORNER BASE UNITS H. 40

ANGOLO CIECO 53 x 53
BLIND CORNER BASE 53 x 53

ANGOLO, 1 ANTA
CORNER BASE, 1 DOOR

NEW

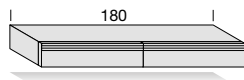

PFC1331K

1.630

mc 0,23 - Kg 23



PFC1967K

625

mc 0,14 - Kg 12

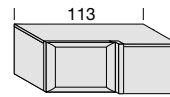

PFC1977K
PFC1978K

1.793

mc 0,30 - Kg 26

1 CESTONE
1 BASKET

1 RIBALTA LEGNO, 1 RIPIANO VETRO
1 WOODEN DROP-DOWN DOOR, 1 GLASS SHELF

A GIORNO, 1 RIPIANO VETRO
OPEN, 1 GLASS SHELF

1 CESTONE
1 BASKET

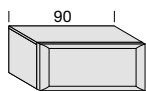

PFC1431K

1.160

mc 0,22 - Kg 32

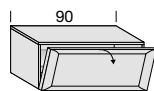

PFC1432K

1.160

mc 0,22 - Kg 30

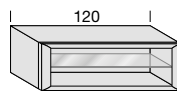

PFC1391K

1.089

mc 0,29 - Kg 32

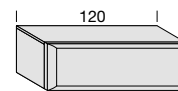

PFC1451K

1.365

mc 0,29 - Kg 41

OPTIONAL
OPTIONAL

KIT SPORTELLINO PASSACAVI
+ BORCHIA
KIT FOR CABLE MANAGEMENT HOLE
+ COVER

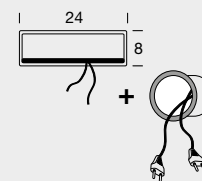

ZZZFE22005

133

KIT PIEDI INTAGLIATI H. 15 CM
KIT FOR CARVED FEET H. 15 CM

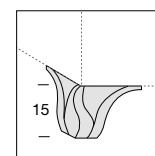

ACS4001K

278

POSSIBILITÀ DI FRONTALE DIVERSO
DALLA SCOCCA, SPECIFICARE LA
FINITURA SCELTA

IN CASE OF FRONT DIFERENT FROM
THE CARCASE CONSIDER THE
HIGHER PRICE OF THE CHOOSEN
FINISH

PORTOFINO SISTEMA COMPONIBILE - MODULAR SYSTEM

PENSILI ORIZZONTALI P. 40

HORIZONTAL WALL UNITS D. 40

PENSILI H. 40

N.B.: POSIZIONAMENTO MAX
PENSILE A RIBALTA H. 160

WALL UNITS H. 40

N.B.: MAX POSITION OF WALL UNIT
WITH DROP-DOWN DOORS H. 160

A GIORNO, 1 RIPIANO VETRO
OPEN, 1 GLASS SHELF

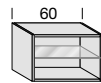

PFC2001K

680

mc 0,10 – Kg 12

1 VASISTAS LEGNO
1 WOODEN LIFT-UP DOOR

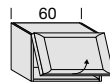

PFC2101K

806

mc 0,10 – Kg 16

1 VASISTAS VETRO
1 GLASS LIFT-UP DOOR

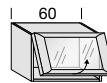

PFC2141K

806

mc 0,10 – Kg 16

1 RIBALTA LEGNO
1 WOODEN DROP-DOWN DOOR

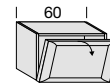

PFC2201K

806

mc 0,10 – Kg 16

1 RIBALTA VETRO
1 GLASS DROP-DOWN DOOR

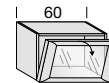

PFC2241K

806

mc 0,10 – Kg 16

NOCE-FRASSINO / WALNUT-ASHWOOD

1 RIBALTA LEGNO
1 WOODEN DROP-DOWN DOOR

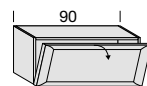

PFC2211K

1.029

mc 0,17 – Kg 21

1 RIBALTA VETRO
1 GLASS DROP-DOWN DOOR



PFC2251K

1.029

mc 0,17 – Kg 21

1 RIBALTA TRAFORATA
1 PERFORATED DROP-DOWN DOOR

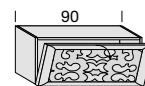

PFC2212K

1.377

mc 0,19 – Kg 21

A GIORNO, 1 RIPIANO VETRO
OPEN, 1 GLASS SHELF

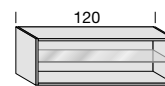

PFC2021K

1.041

mc 0,20 – Kg 19

NOCE-FRASSINO / WALNUT-ASHWOOD

1 RIBALTA VETRO
1 GLASS DROP-DOWN DOOR

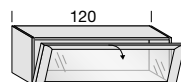

PFC2261K

1.203

mc 0,20 – Kg 26

1 RIBALTA TRAFORATA
1 PERFORATED DROP-DOWN DOOR

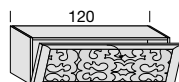

PFC2222K

1.564

mc 0,20 – Kg 26

A GIORNO, 1 RIPIANO VETRO
OPEN, 1 GLASS SHELF

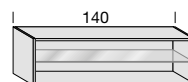

PFC2024K

1.209

mc 0,27 – Kg 21

1 VASISTAS LEGNO
1 WOODEN LIFT-UP DOOR

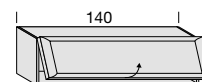

PFC2124K

1.395

mc 0,27 – Kg 29

NOCE-FRASSINO / WALNUT-ASHWOOD

1 RIBALTA TRAFORATA
1 PERFORATED DROP-DOWN DOOR

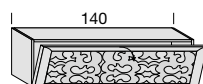

PFC2225K

1.665

mc 0,27 – Kg 29

A GIORNO, 2 RIPIANI VETRO
OPEN, 2 GLASS SHELVES

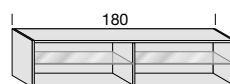

PFC2031K

1.270

mc 0,34 – Kg 25

1 VASISTAS LEGNO
1 WOODEN LIFT-UP DOOR

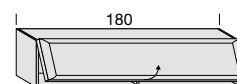

PFC2131K

1.521

mc 0,34 – Kg 36

1 VASISTAS VETRO
1 GLASS LIFT-UP DOOR

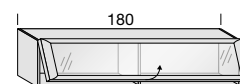

PFC2171K

1.521

mc 0,34 – Kg 36

NOCE-FRASSINO / WALNUT-ASHWOOD

A GIORNO, 1 RIPIANO VETRO
OPEN, 1 GLASS SHELF

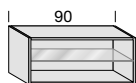

PFC2011K

890

mc 0,17 – Kg 15

1 VASISTAS LEGNO
1 WOODEN LIFT-UP DOOR

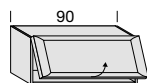

PFC2111K

1.029

mc 0,17 – Kg 21

1 VASISTAS VETRO
1 GLASS LIFT-UP DOOR

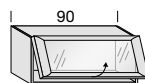

PFC2151K

1.029

mc 0,17 – Kg 21

1 VASISTAS TRAFORATA
1 PERFORATED LIFT-UP DOOR

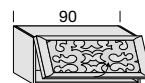

PFC2112K

1.377

mc 0,17 – Kg 21

1 VASISTAS LEGNO
1 WOODEN LIFT-UP DOOR

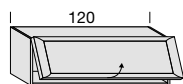

PFC2121K

1.203

mc 0,20 – Kg 26

1 VASISTAS VETRO
1 GLASS LIFT-UP DOOR

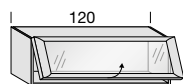

PFC2161K

1.203

mc 0,20 – Kg 26

1 VASISTAS TRAFORATA
1 PERFORATED LIFT-UP DOOR

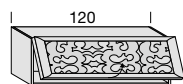

PFC2122K

1.564

mc 0,20 – Kg 26

1 RIBALTA LEGNO
1 WOODEN DROP-DOWN DOOR

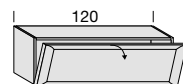

PFC2221K

1.203

mc 0,20 – Kg 26

1 VASISTAS VETRO
1 GLASS LIFT-UP DOOR

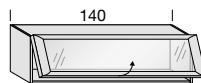

PFC2164K

1.395

mc 0,27 – Kg 29

1 VASISTAS TRAFORATA
1 PERFORATED LIFT-UP DOOR

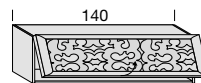

PFC2125K

1.665

mc 0,27 – Kg 29

1 RIBALTA LEGNO
1 WOODEN DROP-DOWN DOOR

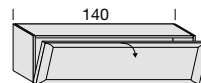

PFC2224K

1.395

mc 0,27 – Kg 29

1 RIBALTA VETRO
1 GLASS DROP-DOWN DOOR

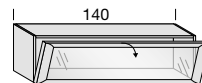

PFC2264K

1.395

mc 0,27 – Kg 29

1 VASISTAS TRAFORATA
1 PERFORATED LIFT-UP DOOR

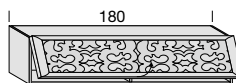

PFC2132K

1.961

mc 0,34 – Kg 36

1 RIBALTA LEGNO
1 WOODEN DROP-DOWN DOOR

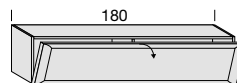

PFC2231K

1.521

mc 0,34 – Kg 36

1 RIBALTA VETRO
1 GLASS DROP-DOWN DOOR

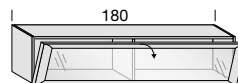

PFC2271K

1.521

mc 0,34 – Kg 36

1 RIBALTA TRAFORATA
1 PERFORATED DROP-DOWN DOOR

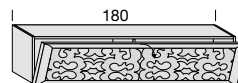

PFC2232K

1.961

mc 0,34 – Kg 36

OPTIONAL OPTIONAL

BARRA LED A BASSO CONSUMO
ACCENSIONE TOUCH
IN ALLUMINIO L. 37.2
LOW CONSUMPTION LED BAR
TOUCH SWITCH
IN ALUMINIUM W. 37.2



ZZZFE22001

163

ALIMENTATORE
POWER SUPPLY



ZZZFE22002

67

COLLEGAMENTO
A CARICO DEL CLIENTE
CONNECTIONS
TO BE MADE BY THE CUSTOMER.

POSSIBILITÀ DI FRONTALE DIVERSO
DALLA SCOCCA, SPECIFICARE LA
FINITURA SCELTA

IN CASE OF FRONT DIFFERENT FROM
THE CARCASE CONSIDER THE
HIGHER PRICE OF THE CHOSEN
FINISH

PORTOFINO SISTEMA COMPONIBILE - MODULAR SYSTEM

PENSILI ORIZZONTALI/VERTICALI P. 40

HORIZONTAL/VERTICAL WALL UNITS D. 40

PENSILI H. 60 WALL UNITS H. 60

A GIORNO, 1 RIPIANO VETRO
OPEN, 1 GLASS SHELF

1 ANTA LEGNO, 1 RIPIANO VETRO
1 WOODEN DOOR, 1 GLASS SHELF

1 ANTA VETRO, 1 RIPIANO VETRO
1 GLASS DOOR, 1 GLASS SHELF

1 ANTA TRAFORATA, 1 RIPIANO VETRO
1 PERFORATED DOOR, 1 GLASS SHELF

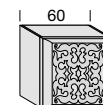
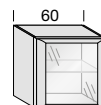
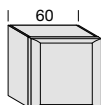
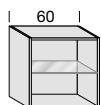

DX / RH
SX / LH

PFC2601K

**PFC2621K
PFC2622K**

**PFC2641K
PFC2642K**

**PFC2651K
PFC2652K**

NOCE-FRASSINO / WALNUT-ASHWOOD

703

903

903

1.191

mc 0,17 – Kg 14

mc 0,17 – Kg 14

mc 0,17 – Kg 14

mc 0,17 – Kg 14

PENSILI H. 64.4 CON CORNICE PERIMETRALE WALL UNITS H. 64.4 WITH PERIMETRIC FRAME

1 ANTA LEGNO, 1 RIPIANO VETRO
1 WOODEN DOOR, 1 GLASS SHELF

1 ANTA VETRO, 1 RIPIANO VETRO
1 GLASS DOOR, 1 GLASS SHELF

1 ANTA TRAFORATA, 1 RIPIANO VETRO
1 PERFORATED DOOR, 1 GLASS SHELF

A GIORNO, 2 RIPIANI VETRO
OPEN, 2 GLASS SHELVES

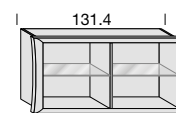
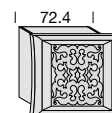
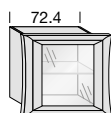
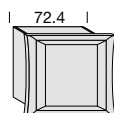

DX / RH
SX / LH

**PFC2701K
PFC2702K**

**PFC2721K
PFC2722K**

**PFC2731K
PFC2732K**

PFC2291K

NOCE-FRASSINO / WALNUT-ASHWOOD

992

992

1.245

1.179

mc 0,23 – Kg 23

mc 0,23 – Kg 23

mc 0,23 – Kg 23

mc 0,41 – Kg 27

PENSILI H. 120 WALL UNITS H. 120

A GIORNO, 2 RIPIANI VETRO
OPEN, 2 GLASS SHELVES

1 ANTA LEGNO, 2 RIPIANI VETRO
1 WOODEN DOOR, 2 GLASS SHELVES

1 ANTA VETRO, 2 RIPIANI VETRO
1 GLASS DOOR, 2 GLASS SHELVES

2 ANTE LEGNO,
2 RIPIANI VETRO
2 WOODEN DOORS,
2 GLASS SHELVES

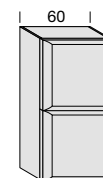
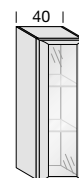
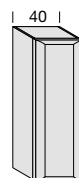

DX / RH
SX / LH

PFC2311K

**PFC2321K
PFC2322K**

**PFC2341K
PFC2342K**

**PFC2411K
PFC2412K**

NOCE-FRASSINO / WALNUT-ASHWOOD

1.041

1.155

1.155

1.395

mc 0,23 – Kg 17

mc 0,23 – Kg 24

mc 0,23 – Kg 24

mc 0,34 – Kg 30

1 ANTA VETRO, 1 ANTA TRAFORATA
2 RIPIANI VETRO
1 GLASS DOOR, 1 PERFORATED DOOR
2 GLASS SHELVES

4 ANTE LEGNO,
4 RIPIANI VETRO
4 WOODEN DOORS,
4 GLASS SHELVES

4 ANTE VETRO,
4 RIPIANI VETRO
4 GLASS DOORS,
4 GLASS SHELVES

4 ANTE TRAFORATE,
4 RIPIANI VETRO
4 PERFORATED DOORS,
4 GLASS SHELVES

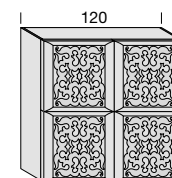
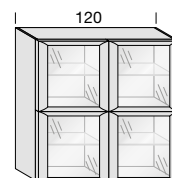
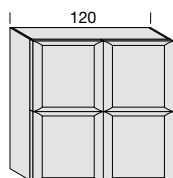
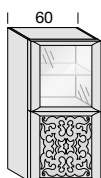

DX / RH
SX / LH

**PFC2561K
PFC2562K**

PFC2811K

PFC2821K

PFC2781K

NOCE-FRASSINO / WALNUT-ASHWOOD

1.479

2.122

2.122

2.525

mc 0,34 – Kg 30

mc 0,68 – Kg 50

mc 0,68 – Kg 50

mc 0,68 – Kg 50

2 ANTE LEGNO, 2 RIPIANI VETRO
2 WOODEN DOORS, 2 GLASS SHELVES

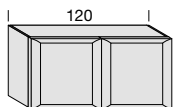

PFC2181K

1.395

mc 0,34 – Kg 32

2 ANTE VETRO, 2 RIPIANI VETRO
2 GLASS DOORS, 2 GLASS SHELVES

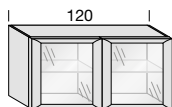

PFC2081K

1.395

mc 0,34 – Kg 32

1 ANTA TRAFORATA, 1 ANTA VETRO, 2 RIPIANI VETRO
1 PERFORATED DOOR, 1 GLASS DOOR, 2 GLASS SHELVES

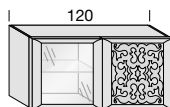

PFC2971K

1.630

mc 0,34 – Kg 32

2 ANTE TRAFORATE, 2 RIPIANI VETRO
2 PERFORATED DOORS, 2 GLASS SHELVES

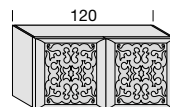

PFC2391K

1.803

mc 0,34 – Kg 32

2 ANTE LEGNO, 2 RIPIANI VETRO
2 WOODEN DOORS, 2 GLASS SHELVES

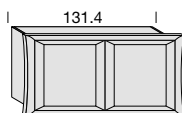

PFC2191K

1.486

mc 0,41 – Kg 38

2 ANTE VETRO, 2 RIPIANI VETRO
2 GLASS DOORS, 2 GLASS SHELVES

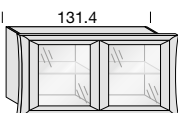

PFC2091K

1.486

mc 0,41 – Kg 38

2 ANTE TRAFORATE, 2 RIPIANI VETRO
2 PERFORATED DOORS, 2 GLASS SHELVES

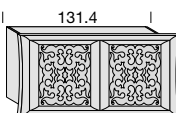

PFC2441K

1.930

mc 0,41 – Kg 38

2 ANTE VETRO,
2 RIPIANI VETRO
2 GLASS DOORS,
2 GLASS SHELVES

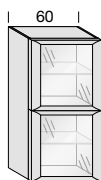

PFC2431K
PFC2432K

1.395

mc 0,34 – Kg 30

2 ANTE TRAFORATE,
2 RIPIANI VETRO
2 PERFORATED DOORS,
2 GLASS SHELVES

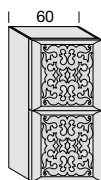

PFC2581K
PFC2582K

1.545

mc 0,34 – Kg 30

1 ANTA VETRO, 1 ANTA LEGNO,
2 RIPIANI VETRO
1 GLASS DOOR, 1 WOODEN DOOR,
2 GLASS SHELVES

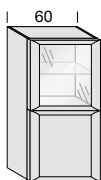

PFC2471K
PFC2472K

1.395

mc 0,34 – Kg 30

1 ANTA LEGNO, 1 ANTA TRAFORATA
2 RIPIANI VETRO
1 WOODEN DOOR, 1 PERFORATED DOOR
2 GLASS SHELVES

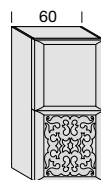

PFC2481K
PFC2482K

1.479

mc 0,34 – Kg 30

2 ANTE TRAFORATE, 2 ANTE LEGNO,
4 RIPIANI VETRO
2 PERFORATED DOORS, 2 WOODEN DOORS,
4 GLASS SHELVES

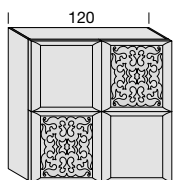

PFC2711K

2.393

mc 0,68 – Kg 50

2 ANTE VETRO, 2 ANTE LEGNO,
4 RIPIANI VETRO
2 GLASS DOORS, 2 WOODEN DOORS,
4 GLASS SHELVES

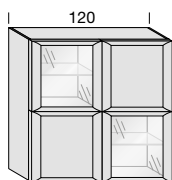

PFC2861K

2.122

mc 0,68 – Kg 50

2 ANTE VETRO, 2 ANTE TRAFORATE,
4 RIPIANI VETRO
2 GLASS DOORS, 2 PERFORATED DOORS,
4 GLASS SHELVES

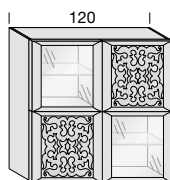

PFC2881K

2.393

mc 0,68 – Kg 50

OPTIONAL OPTIONAL

BARRA LED A BASSO CONSUMO
ACCENSIONE TOUCH
IN ALLUMINIO L. 37.2
LOW CONSUMPTION LED BAR
TOUCH SWITCH
IN ALUMINIUM W. 37.2



ZZZFE22001

163

ALIMENTATORE
POWER SUPPLY



ZZZFE22002

67

COLLEGAMENTO
A CARICO DEL CLIENTE
CONNECTIONS
TO BE MADE BY THE CUSTOMER.

POSSIBILITÀ DI FRONTALE DIVERSO
DALLA SCOCCA, SPECIFICARE LA
FINITURA SCELTA

IN CASE OF FRONT DIFFERENT FROM
THE CARCASE CONSIDER THE
HIGHER PRICE OF THE CHOSEN
FINISH

PORTOFINO SISTEMA COMPONIBILE - MODULAR SYSTEM

PENSILI VERTICALI P. 40/41

VERTICAL WALL UNITS D. 40/41

PENSILI H. 124.4 WALL UNITS H. 124.4

A GIORNO, 2 RIPIANI VETRO
OPEN, 2 GLASS SHELVES

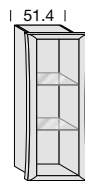

DX / RH
SX / LH

PFC2371K

2 ANTE LEGNO,
2 RIPIANI VETRO
2 WOODEN DOORS,
2 GLASS SHELVES

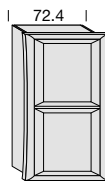

**PFC2501K
PFC2502K**

2 ANTE VETRO,
2 RIPIANI VETRO
2 GLASS DOORS,
2 GLASS SHELVES

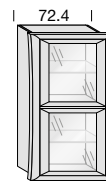

**PFC2521K
PFC2522K**

2 ANTE TRAFORATE,
2 RIPIANI VETRO
2 PERFORATED DOORS,
2 GLASS SHELVES

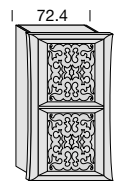

**PFC2591K
PFC2592K**

NOCE-FRASSINO / WALNUT-ASHWOOD

1.089

mc 0,32 – Kg 20

1.486

mc 0,44 – Kg 36

1.486

mc 0,44 – Kg 36

1.665

mc 0,44 – Kg 36

4 ANTE VETRO,
4 RIPIANI VETRO
4 GLASS DOORS,
4 GLASS SHELVES

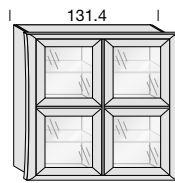

PFC2851K

4 ANTE TRAFORATE,
4 RIPIANI VETRO
4 PERFORATED DOORS,
4 GLASS SHELVES

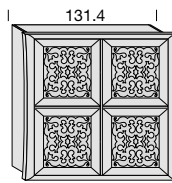

PFC2791K

2 ANTE TRAFORATE, 2 ANTE LEGNO,
4 RIPIANI VETRO
2 PERFORATED DOORS, 2 WOODEN DOORS,
4 GLASS SHELVES

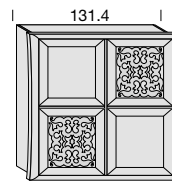

PFC2771K

2 ANTE VETRO, 2 ANTE LEGNO,
4 RIPIANI VETRO
2 GLASS DOORS, 2 WOODEN DOORS,
4 GLASS SHELVES

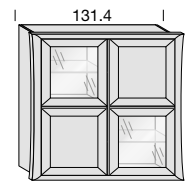

PFC2871K

NOCE-FRASSINO / WALNUT-ASHWOOD

2.279

mc 0,80 – Kg 58

2.664

mc 0,80 – Kg 58

2.514

mc 0,80 – Kg 58

2.279

mc 0,80 – Kg 58

MADIE P. 40/50 CUPBOARDS D. 40/50

MADIA H. 63 P. 40 CUPBOARD H. 63 D. 40

2 ANTE LEGNO, 3 CASSETTI, 2 RIPIANI VETRO
2 WOODEN DOORS, 3 DRAWERS, 2 GLASS SHELVES

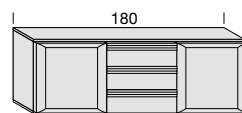

PFC6101K

2 ANTE TRAFORATE, 3 CASSETTI, 2 RIPIANI VETRO
2 PERFORATED DOORS, 3 DRAWERS, 2 GLASS SHELVES

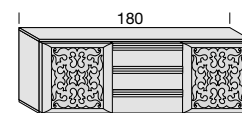

PFC6201K

NOCE-FRASSINO / WALNUT-ASHWOOD

2.410

mc 0,54 – Kg 80

2.778

mc 0,54 – Kg 80

MADIA H. 63 P. 50 CUPBOARD H. 63 D. 50

2 ANTE LEGNO, 3 CASSETTI, 2 RIPIANI VETRO
2 WOODEN DOORS, 3 DRAWERS, 2 GLASS SHELVES



PFC6105K

2 ANTE TRAFORATE, 3 CASSETTI, 2 RIPIANI VETRO
2 PERFORATED DOORS, 3 DRAWERS, 2 GLASS SHELVES



PFC6205K

NOCE-FRASSINO / WALNUT-ASHWOOD

2.627

mc 0,67 – Kg 100

2.988

mc 0,67 – Kg 100

1 ANTA VETRO, 1 ANTA LEGNO,
2 RIPIANI VETRO
1 GLASS DOOR, 1 WOODEN DOOR,
2 GLASS SHELVES

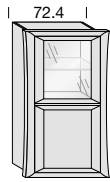

PFC2541K
PFC2542K

1.486

mc 0,44 – Kg 36

1 ANTA LEGNO, 1 ANTA TRAFORATA
2 RIPIANI VETRO
1 WOODEN DOOR, 1 PERFORATED DOOR
2 GLASS SHELVES

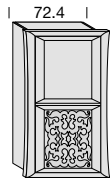

PFC2551K
PFC2552K

1.587

mc 0,44 – Kg 36

1 ANTA VETRO, 1 ANTA TRAFORATA
2 RIPIANI VETRO
1 GLASS DOOR, 1 PERFORATED DOOR
2 GLASS SHELVES

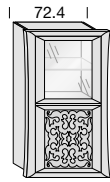

PFC2571K
PFC2572K

1.587

mc 0,44 – Kg 36

4 ANTE LEGNO,
4 RIPIANI VETRO
4 WOODEN DOORS,
4 GLASS SHELVES

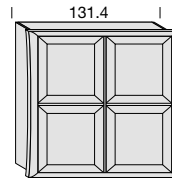

PFC2841K

2.279

mc 0,80 – Kg 58

2 ANTE VETRO, 2 ANTE TRAFORATE,
4 RIPIANI VETRO
2 GLASS DOORS, 2 PERFORATED DOORS,
4 GLASS SHELVES

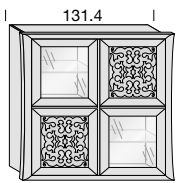

PFC2891K

2.514

mc 0,80 – Kg 58

4 ANTE LEGNO, 2 RIPIANI VETRO
4 WOODEN DOORS, 2 GLASS SHELVES

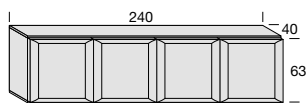

PFC6111K

2.669

mc 0,72 – Kg 112

4 ANTE TRAFORATE, 2 RIPIANI VETRO
4 PERFORATED DOORS, 2 GLASS SHELVES

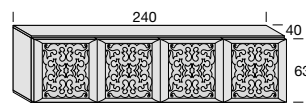

PFC6181K

3.463

mc 0,72 – Kg 112

4 ANTE LEGNO, 2 RIPIANI VETRO
4 WOODEN DOORS, 2 GLASS SHELVES



PFC6115K

2.946

mc 0,90 – Kg 140

4 ANTE TRAFORATE, 2 RIPIANI VETRO
4 PERFORATED DOORS, 2 GLASS SHELVES



PFC6185K

3.745

mc 0,90 – Kg 140

OPTIONAL OPTIONAL

BARRA LED A BASSO CONSUMO
ACCENSIONE TOUCH
IN ALLUMINIO L. 37.2
LOW CONSUMPTION LED BAR
TOUCH SWITCH
IN ALUMINIUM W. 37.2



ZZZFE22001

163

ALIMENTATORE
POWER SUPPLY



ZZZFE22002

67

COLLEGAMENTO
A CARICO DEL CLIENTE
CONNECTIONS
TO BE MADE BY THE CUSTOMER.

KIT PIEDI INTAGLIATI H. 15 CM
KIT FOR CARVED FEET H. 15 CM

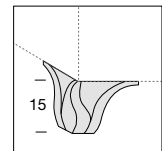

ACS4001K

278

POSSIBILITÀ DI FRONTALE DIVERSO
DALLA SCOCCA, SPECIFICARE LA
FINITURA SCELTA

IN CASE OF FRONT DIFFERENT FROM
THE CARCASE CONSIDER THE
HIGHER PRICE OF THE CHOSEN
FINISH

PORTOFINO SISTEMA COMPONIBILE - MODULAR SYSTEM

SISTEMA COMPONIBILE

MODULAR SYSTEM

VETRINA H. 208 P. 40
DISPLAY UNIT H. 208 D. 40

2 ANTE LEGNO, 4 RIPIANI VETRO
 2 WOODEN DOORS, 4 GLASS SHELVES

2 ANTE VETRO, 4 RIPIANI VETRO
 2 GLASS DOORS, 4 GLASS SHELVES

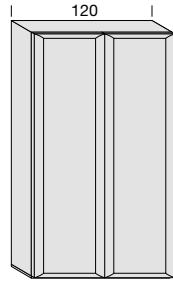

	PFC6001K	OPTIONAL		PFC6011K	OPTIONAL	
		PIEDI FEET			PIEDI FEET	
		PIEDI INTAGLIO H. 15 CM CARVED FEET H. 15 CM	PIEDI NICHEL NICKEL FEET		PIEDI INTAGLIO H. 15 CM CARVED FEET H. 15 CM	PIEDI NICHEL NICKEL FEET
NOCE-FRASSINO / WALNUT-ASHWOOD	2.892	+ 278	+ 253	2.892	+ 278	+ 253
	mc 1,18 – Kg 96			mc 1,18 – Kg 96		

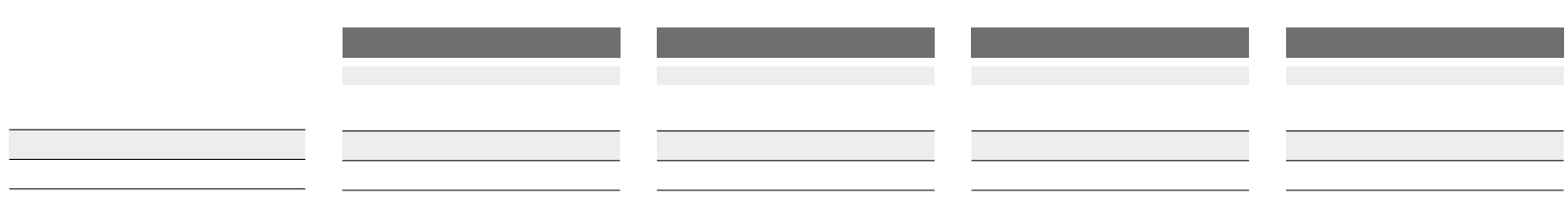
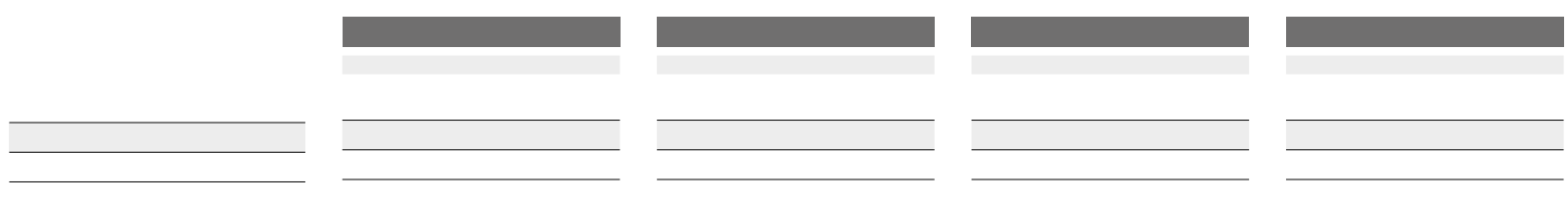

2 ANTE VETRO CON FASCIA TRAFORATA,
4 RIPIANI VETRO
2 GLASS DOORS WITH PERFORATED
STRIP, 4 GLASS SHELVES



PFC6021K	OPTIONAL			
	PIEDI FEET			
	PIEDI INTAGLIO H. 15 CM CARVED FEET H. 15 CM	PIEDI NICHEL NICKEL FEET		
3.342	+ 278	+ 253		
mc 1,18 – Kg 96				

OPTIONAL OPTIONAL

BARRA LED A BASSO CONSUMO
ACCENSIONE TOUCH
IN ALLUMINIO L. 37.2
LOW CONSUMPTION LED BAR
TOUCH SWITCH
IN ALUMINIUM W. 37.2



ZZZFE22001

163

ALIMENTATORE
POWER SUPPLY



ZZZFE22002

67

COLLEGAMENTO
A CARICO DEL CLIENTE
CONNECTIONS
TO BE MADE BY THE CUSTOMER.

KIT PIEDI INTAGLIATI H. 15 CM
KIT FOR CARVED FEET H. 15 CM

ACS4001K
278

POSSIBILITÀ DI FRONTALE DIVERSO
DALLA SCOCCA, SPECIFICARE LA
FINITURA SCELTA

IN CASE OF FRONT DIFFERENT FROM
THE CARCASE CONSIDER THE
HIGHER PRICE OF THE CHOSEN
FINISH

PORTOFINO SISTEMA COMPONIBILE - MODULAR SYSTEM

COMPOSIZIONI A CATALOGO

CATALOGUE COMPOSITIONS

COMPOSIZIONE 182

COMPOSITION 182

PAG. 78 CATALOGO "PROPOSTE ARREDATIVE"
PAGE 78 "FURNISHING SOLUTIONS" CATALOGUE

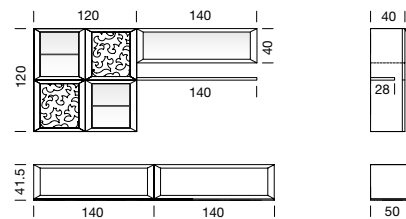
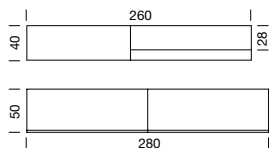

2	PFC1184K	BASE A TERRA CON CESTONE L 140 P 50 FLOOR-STANDING BASE UNIT WITH BASKET W 140 D 50	3.318
1	PFC2881K	PENSILE 2 ANTE VETRO 2 ANTE TRAFORATE L 120 H 120 WALL UNIT WITH 2 GLASS DOORS H 54 2 PERFORATED DOORS H 54 W 120 H 120	2.393
1	PFC2164K	PENSILE VASTISTAS ANTA VETRO L 140 WALL UNIT WITH GLASS LIFT-UP DOOR W 140	1.395
1	PFC3541K	MENSOLA L 140 SHELF W 140	308
PFC0182K PREZZO TOTALE COMPOSIZIONE TOTAL PRICE FOR COMPOSITION			7.414

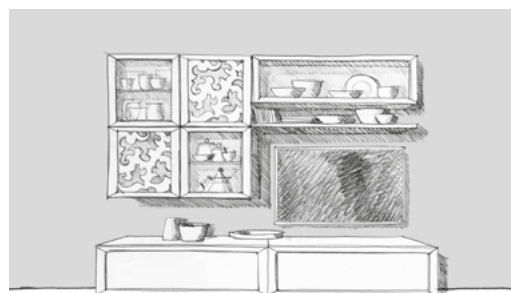

L. W. 280
P. D. 40/50

COMPOSIZIONE 184

COMPOSITION 184

PAG. 79 CATALOGO "PROPOSTE ARREDATIVE"
PAGE 79 "FURNISHING SOLUTIONS" CATALOGUE

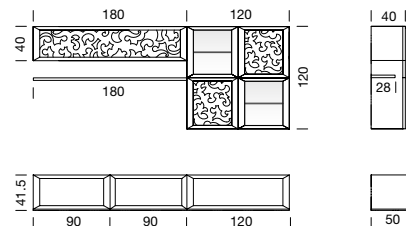
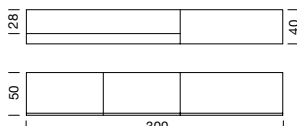

2	PFC1161K	BASE A TERRA CON CESTONE L 90 P 50 FLOOR-STANDING BASE UNIT WITH BASKET W 90 D 50	2.320
1	PFC1181K	BASE A TERRA CON CESTONE L 120 P 50 FLOOR-STANDING BASE UNIT WITH BASKET W 120 D 50	1.365
1	PFC2132K	PENSILE VASTISTAS ANTA TRAFORATA L 180 WALL UNIT WITH PERFORATED LIFT-UP DOOR W 180	1.961
1	PFC2881K	PENSILE 2 ANTE VETRO 2 ANTE TRAFORATE L 120 H 120 WALL UNIT WITH 2 GLASS DOORS H 54 2 PERFORATED DOORS H 54 W 120 H 120	2.393
1	PFC3531K	MENSOLA L 180 SHELF W 180	386
PFC0184K PREZZO TOTALE COMPOSIZIONE TOTAL PRICE FOR COMPOSITION			8.425

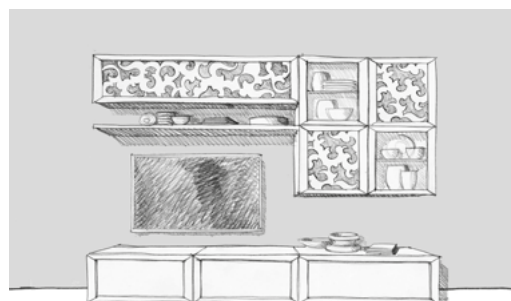

L. W. 300
P. D. 40/50

COMPOSIZIONE 186

COMPOSITION 186

PAG. 80 CATALOGO "PROPOSTE ARREDATIVE"
PAGE 80 "FURNISHING SOLUTIONS" CATALOGUE

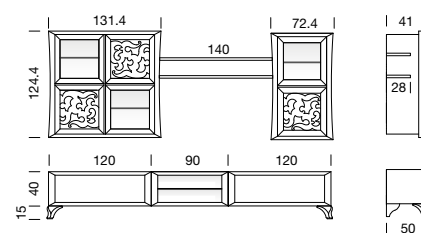
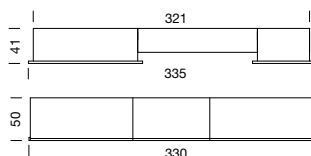

2	PFC1451K	BASE CESTONE SOSPESA L 120 P 50 SUSPENDED BASE UNIT WITH BASKET W 120 D 50	2.730
1	PFC1371K	BASE A GIORNO SOSPESA L 90 P 50 OPEN SUSPENDED BASE UNIT W 90 D 50	871
1	ACS4001K	KIT PIEDI INTAGLIO KIT FOR ENGRAVING FEET	278
1	PFC2891K	PENSILE 2 ANTE VETRO 2 ANTE TRAFORATE CON CORNICE PERIMETRALE L 131,4 H 124,4 WALL UNIT WITH 2 GLASS DOORS 2 PERFORATED DOORS WITH PERIMETRIC FRAME W 131,4 H 124,4	2.514
1	PFC2571K	PENSILE ANTA VETRO ANTA TRAFORATA CON CORNICE PERIMETRALE L 72,4 H 124,4 WALL UNIT WITH GLASS DOOR PERFORATED DOOR WITH PERIMETRIC FRAME W 72,4 H 124,4	1.587
2	PFC3541K	MENSOLE L 140 SHELVES W 140	616
PFC0186K PREZZO TOTALE COMPOSIZIONE TOTAL PRICE FOR COMPOSITION			8.596

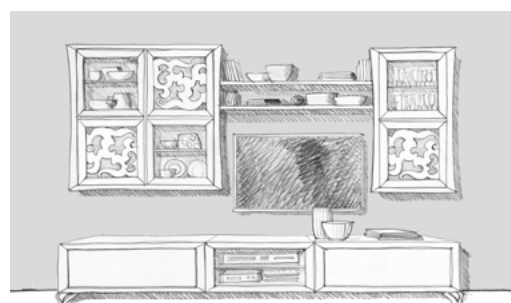

L. W. 335
P. D. 40/50

COMPOSIZIONI A CATALOGO CATALOGUE COMPOSITIONS

COMPOSIZIONE 188

COMPOSITION 188

PAG. 81 CATALOGO "PROPOSTE ARREDATIVE"
PAGE 81 "FURNISHING SOLUTIONS" CATALOGUE

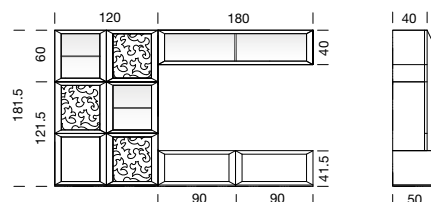
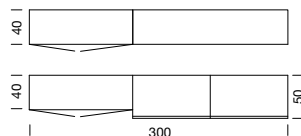

		NOCE FRASSINO
2	PFC1161K BASE A TERRA CON CESTONE L 90 P 50 FLOOR-STANDING BASE UNIT WITH BASKET W 90 D 50	2.320
1	PFC6171K MADIA ANTA VETRO, ANTA LEGNO E 2 ANTE TRAFORATE L 120 H 121,5 CUPBOARD GLASS DOOR, WOODEN DOOR AND 2 PERFORATED DOORS W 120 H 121.5	2.793
1	PFC2971K PENSILE ANTA VETRO E ANTA TRAFORATA L 120 H 60 WALL UNIT WITH GLASS DOOR AND PERFORATED DOOR W 120 H 60	1.630
1	PFC2171K PENSILE VASISTAS ANTA VETRO L 180 WALL UNIT WITH GLASS LIFT-UP DOOR W 180	1.521
PFC0188K PREZZO TOTALE COMPOSIZIONE TOTAL PRICE FOR COMPOSITION		8.264

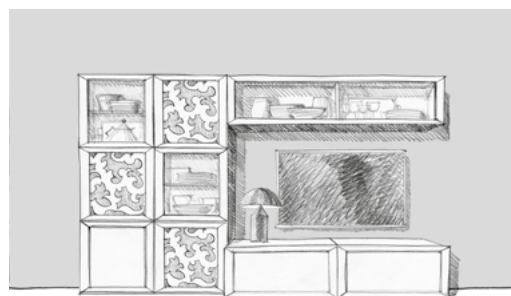

L. W. 300
P. D. 40/50

COMPOSIZIONE 190

COMPOSITION 190

PAG. 82 CATALOGO "PROPOSTE ARREDATIVE"
PAGE 82 "FURNISHING SOLUTIONS" CATALOGUE

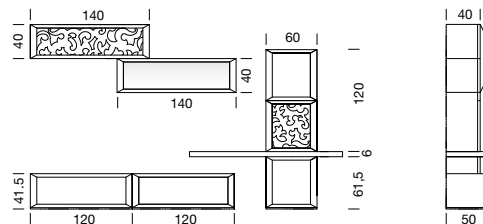
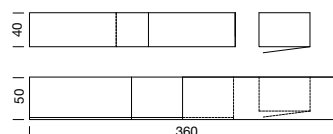

		NOCE FRASSINO
2	PFC1181K BASE A TERRA CON CESTONE L 120 P 50 FLOOR-STANDING BASE UNIT WITH BASKET W 120 D 50	2.730
1	PFC3331K BASE A TERRA ANTA LEGNO L 60 H 61,5 P 40 FLOOR-STANDING BASE UNIT WITH WOODEN DOOR W 60 H 61.5 D 40	975
1	DCC3031K MENSOLONE L 180 P 50 LARGE SHELF W 180 D 50	554
1	PFC2481K PENSILE ANTA LEGNO E ANTA TRAFORATA L 60 H 120 WALL UNIT WITH WOODEN DOOR AND PERFORATED DOOR W 60 H 120	1.479
1	PFC2125K PENSILE VASISTAS ANTA TRAFORATA L 140 WALL UNIT WITH PERFORATED LIFT-UP DOOR W 140	1.665
1	PFC2264K PENSILE RIBALTA ANTA VETRO L 140 WALL UNIT WITH GLASS DROP-DOWN DOOR W 140	1.395
PFC0190K PREZZO TOTALE COMPOSIZIONE TOTAL PRICE FOR COMPOSITION		8.798

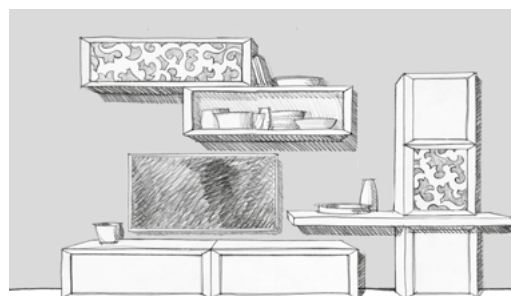

L. W. 360
P. D. 40/50

COMPOSIZIONE 190/B

COMPOSITION 190/B

PAG. 83 CATALOGO "PROPOSTE ARREDATIVE"
PAGE 83 "FURNISHING SOLUTIONS" CATALOGUE

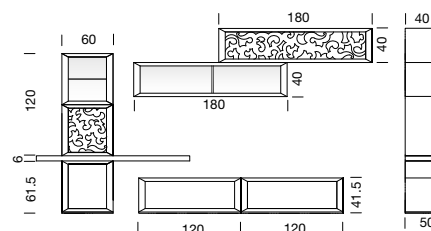
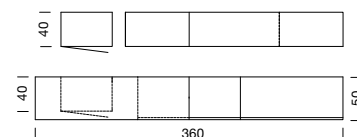

		NOCE FRASSINO
2	PFC1181K BASE A TERRA CON CESTONE L 120 P 50 FLOOR-STANDING BASE UNIT WITH BASKET W 120 D 50	2.730
1	PFC3332K BASE A TERRA ANTA LEGNO L 60 H 61,5 P 40 FLOOR-STANDING BASE UNIT WITH WOODEN DOOR W 60 H 61.5 D 40	975
1	DCC3031K MENSOLONE L 180 P 50 LARGE SHELF W 180 D 50	554
1	PFC2562K PENSILE ANTA VETRO E ANTA TRAFORATA L 60 H 120 WALL UNIT WITH GLASS DOOR AND PERFORATED DOOR W 60 H 120	1.479
1	PFC2132K PENSILE VASISTAS ANTA TRAFORATA L 180 WALL UNIT WITH PERFORATED LIFT-UP DOOR W 180	1.961
1	PFC2271K PENSILE RIBALTA ANTA VETRO L 180 WALL UNIT WITH GLASS DROP-DOWN DOOR W 180	1.521
PREZZO TOTALE COMPOSIZIONE TOTAL PRICE FOR COMPOSITION		9.220

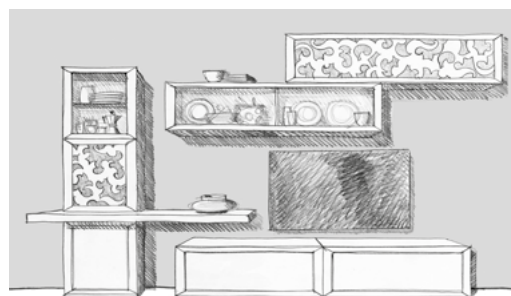

L. W. 360
P. D. 40/50

PORTOFINO SISTEMA COMPONIBILE - MODULAR SYSTEM

COMPOSIZIONI A CATALOGO

CATALOGUE COMPOSITIONS

COMPOSIZIONE 194

COMPOSITION 194

PAG. 84 CATALOGO "PROPOSTE ARREDATIVE"
PAGE 84 "FURNISHING SOLUTIONS" CATALOGUE

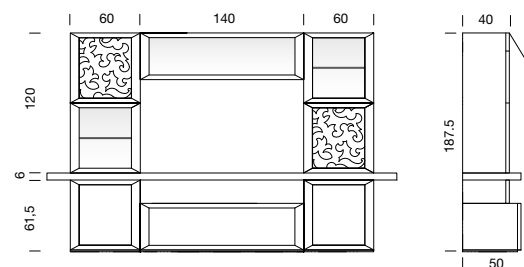
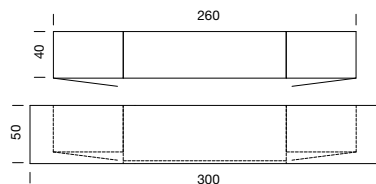

			NOCE FRASSINO
1	PFC1184K	BASE A TERRA CON CESTONE L 140 P 50 FLOOR-STANDING BASE UNIT WITH BASKET W 140 D 50	1.659
1	PFC3332K	BASE A TERRA ANTA LEGNO L 60 H 61,5 P 40 (SX) FLOOR-STANDING BASE UNIT WITH WOODEN DOOR W 60 H 61.5 D 40 (LH)	975
1	PFC3331K	BASE A TERRA ANTA LEGNO L 60 H 61,5 P 40 (DX) FLOOR-STANDING BASE UNIT WITH WOODEN DOOR W 60 H 61.5 D 40 (RH)	975
1	DCC3071K	MENSOLONE L 300 P 50 LARGE SHELF W 300 D 50	890
1	PFC2562K	PENSILE ANTA VETRO E ANTA TRAFORATA L 60 H 120 (SX) WALL UNIT WITH GLASS DOOR AND PERFORATED DOOR W 60 H 120 (LH)	1.479
1	PFC2561K	PENSILE ANTA VETRO E ANTA TRAFORATA L 60 H 120 (DX) WALL UNIT WITH GLASS DOOR AND PERFORATED DOOR W 60 H 120 (RH)	1.479
1	PFC2164K	PENSILE VASISTAS ANTA VETRO L 140 WALL UNIT WITH GLASS LIFT-UP DOOR W 140	1.395
PFC0194K PREZZO TOTALE COMPOSIZIONE TOTAL PRICE FOR COMPOSITION			8.852

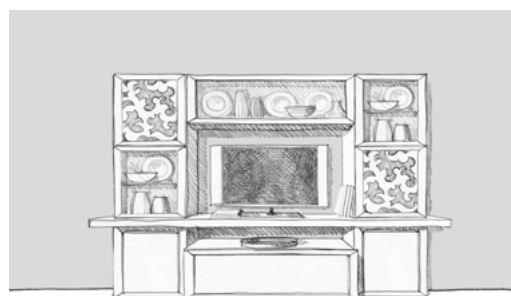

L. W. 300
P. D. 40/50

COMPOSIZIONE 196

COMPOSITION 196

PAG. 85 CATALOGO "PROPOSTE ARREDATIVE"
PAGE 85 "FURNISHING SOLUTIONS" CATALOGUE

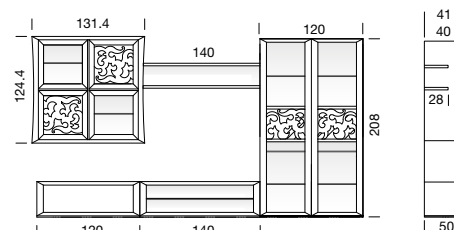
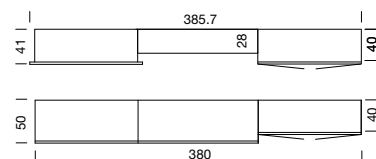

			NOCE FRASSINO
1	PFC1181K	BASE A TERRA CON CESTONE L 120 P 50 FLOOR-STANDING BASE UNIT WITH BASKET W 120 D 50	1.365
1	PFC1124K	BASE A TERRA A GIORNO L 140 P 50 CON RIPIANO VETRO OPEN FLOOR-STANDING BASE UNIT W 140 D 50 WITH GLASS SHELF	1.341
1	PFC6021K	VETRINA 2 ANTE VETRO L 120 H 208 CON FASCIA CENTRALE TRAFORATA DISPLAY UNIT WITH 2 GLASS DOORS W 120 H 208 WITH PERFORATED CENTRAL STRIP	3.342
1	PFC2891K	PENSILE 2 ANTE VETRO 2 ANTE TRAFORATE CON CORNICE PERIMETRALE L 131,4 H 124,4 WALL UNIT WITH 2 GLASS DOORS 2 PERFORATED DOORS WITH PERIMETRIC FRAME W 131.4 H 124.4	2.514
2	PFC3541K	MENSOLE L 140 SHELVES W 140	616
PFC0196K PREZZO TOTALE COMPOSIZIONE TOTAL PRICE FOR COMPOSITION			9.178



L. W. 380
P. D. 40/50

COMPOSIZIONE 198

COMPOSITION 198

PAG. 86 CATALOGO "PROPOSTE ARREDATIVE"
PAGE 86 "FURNISHING SOLUTIONS" CATALOGUE

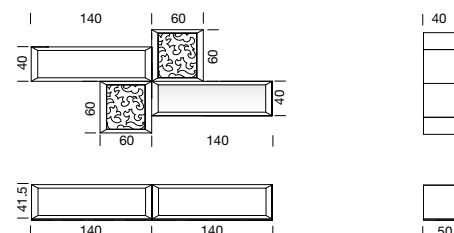
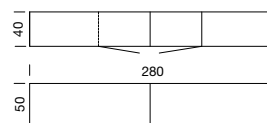

			NOCE FRASSINO
2	PFC1184K	BASE A TERRA CON CESTONE L 140 P 50 FLOOR-STANDING BASE UNIT WITH BASKET W 140 D 50	3.318
1	PFC2652K	PENSILE ANTA TRAFORATA L 60 H 60 (SX) WALL UNIT WITH PERFORATED DOOR W 60 H 60 (LH)	1.191
1	PFC2651K	PENSILE ANTA TRAFORATA L 60 H 60 (DX) WALL UNIT WITH PERFORATED DOOR W 60 H 60 (RH)	1.191
1	PFC2124K	PENSILE VASISTAS ANTA LEGNO L 140 WALL UNIT WITH WOODEN LIFT-UP DOOR W 140	1.395
1	PFC2264K	PENSILE RIBALTA ANTA VETRO L 140 WALL UNIT WITH GLASS DROP-DOWN DOOR W 140	1.395
PFC0198K PREZZO TOTALE COMPOSIZIONE TOTAL PRICE FOR COMPOSITION			8.490



L. W. 280
P. D. 40/50

COMPOSIZIONI A CATALOGO CATALOGUE COMPOSITIONS

POSSIBILITÀ DI FRONTALE DIVERSO DALLA SCOCCA, SPECIFICARE LA FINITURA SCELTA
IN CASE OF FRONT DIFFERENT FROM THE CARCASE CONSIDER THE HIGHER PRICE OF THE CHOOSEN FINISH

COMPOSIZIONE 100 COMPOSITION 100

PAG. 87 CATALOGO "PROPOSTE ARREDATIVE"
PAGE 87 "FURNISHING SOLUTIONS" CATALOGUE

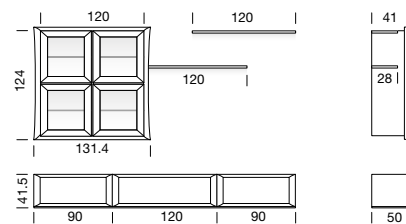
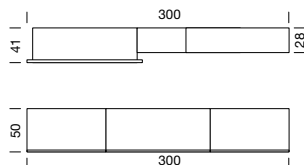

			NOCE FRASSINO
2	PFC1161K	BASE A TERRA CON CESTONE L 90 P 50 FLOOR-STANDING BASE UNIT WITH BASKET W 90 D 50	2.320
1	PFC1181K	BASE A TERRA CON CESTONE L 120 P 50 FLOOR-STANDING BASE UNIT WITH BASKET W 120 D 50	1.365
1	PFC2851K	PENSILE 4 ANTE VETRO CON CORNICE PERIMETRALE L 131,4 H 124,4 WALL UNIT WITH 4 GLASS DOORS WITH PERIMETRIC FRAME W 131,4 H 124,4	2.279
2	PFC3521K	MENSOLA L 120 SHELVES W 120	542
PFC0100K PREZZO TOTALE COMPOSIZIONE TOTAL PRICE FOR COMPOSITION			6.506

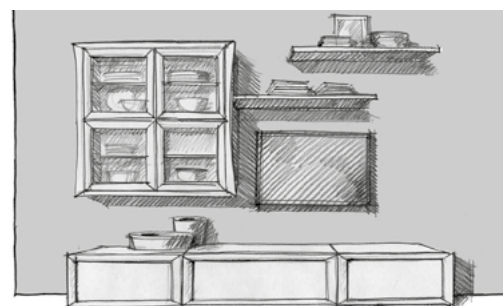

L. W. 300
P. D. 41/50

COMPOSIZIONE 115 COMPOSITION 115

PAG. 88 CATALOGO "PROPOSTE ARREDATIVE"
PAGE 88 "FURNISHING SOLUTIONS" CATALOGUE

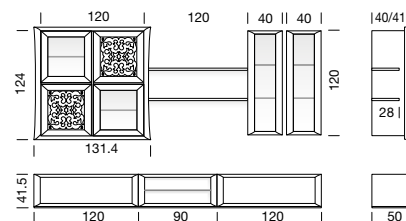
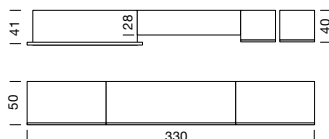

			NOCE FRASSINO
2	PFC1181K	BASE A TERRA CON CESTONE L 120 P 50 FLOOR-STANDING BASE UNIT WITH BASKET W 120 D 50	2.730
1	PFC1101K	BASE A TERRA A GIORNO CON RIPIANO VETRO L 90 P 50 OPEN FLOOR-STANDING BASE UNIT WITH GLASS SHELF W 90 D 50	871
1	PFC2891K	PENSILE 2 ANTE VETRO 2 ANTE TRAFORATE CON CORNICE PERIMETRALE L 131,4 H 124,4 WALL UNIT WITH PERIMETRIC FRAME 2 GLASS DOORS 2 PERFORATED DOORS W 131,4 H 124,4	2.514
2	PFC2341K	PENSILE ANTA VETRO L 40 H 120 VERTICAL WALL UNIT WITH GLASS DOOR W 40 H 120	2.310
2	PFC3521K	MENSOLA L 120 SHELVES W 120	542
PFC0115K PREZZO TOTALE COMPOSIZIONE TOTAL PRICE FOR COMPOSITION			8.967

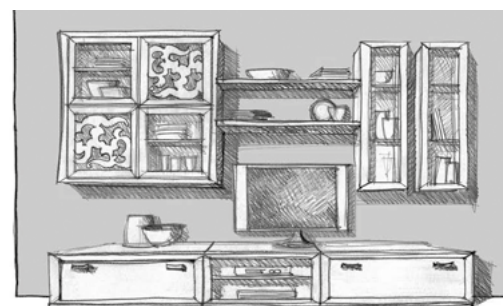

L. W. 330
P. D. 40/50

COMPOSIZIONE 116 COMPOSITION 116

PAG. 72-73 CATALOGO "MODOZINE" E
PAG. 70-71 CATALOGO "PORTOFINO NEW"
PAGE 72-72 "MODOZINE" AND
PAGE 70-71 "PORTOFINO NEW" CATALOGUE

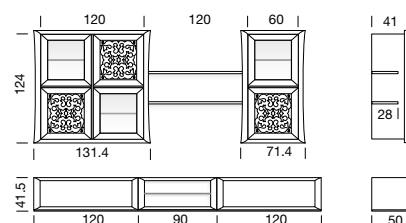
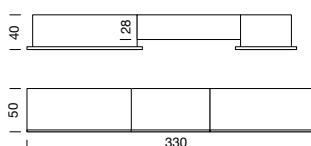

			NOCE FRASSINO
2	PFC1181K	BASE A TERRA CON CESTONE L 120 P 50 FLOOR-STANDING BASE UNIT WITH BASKET W 120 D 50	2.730
1	PFC1101K	BASE A TERRA A GIORNO CON RIPIANO VETRO L 90 P 50 OPEN FLOOR-STANDING BASE UNIT WITH GLASS SHELF W 90 D 50	871
1	PFC2891K	PENSILE 2 ANTE VETRO 2 ANTE TRAFORATE CON CORNICE PERIMETRALE L 131,4 H 124,4 WALL UNIT WITH PERIMETRIC FRAME 2 GLASS DOORS 2 PERFORATED DOORS W 131,4 H 124,4	2.514
1	PFC2571K	PENSILE ANTA VETRO E ANTA TRAFORATA CON CORNICE PERIMETRALE L 71,4 H 124,4 WALL UNIT WITH PERIMETRIC FRAME GLASS DOOR PERFORATED DOOR W 71,4 H 124,4	1.587
2	PFC3521K	MENSOLA L 120 SHELVES W 120	542
PFC0116K PREZZO TOTALE COMPOSIZIONE TOTAL PRICE FOR COMPOSITION			8.244



L. W. 330
P. D. 41/50

PORTOFINO SISTEMA COMPONIBILE - MODULAR SYSTEM

COMPOSIZIONI A CATALOGO CATALOGUE COMPOSITIONS

IN CASE OF FRONT DIFFERENT FROM THE CARCASE CONSIDER THE HIGHER PRICE OF THE CHOSEN FINISH

COMPOSIZIONE 04

COMPOSITION 04

PAG. 108-109 CATALOGO "PORTOFINO NEW"
PAGE 108-109 "PORTOFINO NEW" CATALOGUE

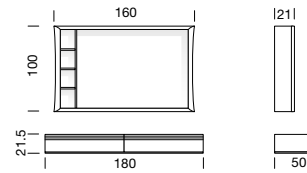
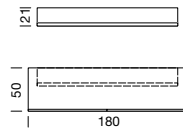

		NOCE FRASSINO
1	PFC1061K BASE A TERRA CON 2 CASSETTI L 180 P 50 FLOOR-STANDING BASE UNIT WITH 2 DRAWERS WITH RIDGED FRONT W 180 D 50	1.630
1	PFC8001K PORTA TV SOSPESO BOX BLOCK CON LIBRERIA L 160 H 100 BOX BLOCK SUSPENDED TV UNIT WITH BOOKCASE W 160 H 100	1.882
PFC0004K PREZZO TOTALE COMPOSIZIONE TOTAL PRICE FOR COMPOSITION		3.512



L. W. 180
P. D. 21/50

COMPOSIZIONE 06/B

COMPOSITION 06/B

PAG. 100-101 CATALOGO "PORTOFINO NEW"
PAGE 100-101 "PORTOFINO NEW" CATALOGUE

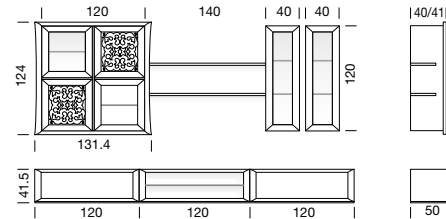
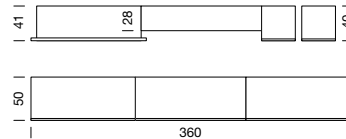

		NOCE FRASSINO
2	PFC1181K BASE A TERRA CON CESTONE L 120 P 50 FLOOR-STANDING BASE UNIT WITH BASKET W 120 D 50	2.730
1	PFC1121K BASE A TERRA A GIORNO CON RIPIANO VETRO L 120 P 50 OPEN FLOOR-STANDING BASE UNIT WITH GLASS SHELF W 120 D 50	1.089
1	PFC2891K PENSILE 2 ANTE VETRO 2 ANTE TRAFORATE CON CORNICE PERIMETRALE L 131,4 H 124,4 WALL UNIT WITH 4 GLASS DOORS AND PERIMETRIC FRAME W 131,4 H 124,4	2.514
2	PFC2341K PENSILE ANTA VETRO L 40 H 120 VERTICAL WALL UNIT WITH GLASS DOOR W 40 H 120	2.310
2	PFC3541K MENSOLA L 140 SHELF W 140	616
PFC006BK PREZZO TOTALE COMPOSIZIONE TOTAL PRICE FOR COMPOSITION		9.259



L. W. 360
P. D. 40/50

COMPOSIZIONE 108

COMPOSITION 108

PAG. 89 CATALOGO "PROPOSTE ARREDATIVE"
PAGE 89 "FURNISHING SOLUTIONS" CATALOGUE

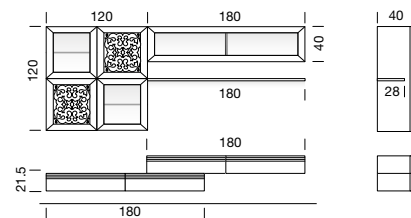
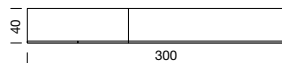

		NOCE FRASSINO
2	PFC1321K BASE SOSPESA 2 CASSETTI L 180 P 40 SUSPENDED BASE UNIT WITH 2 DRAWERS W 180 D 40	3.164
1	PFC2881K PENSILE 2 ANTE VETRO 2 ANTE TRAFORATE L 120 H 120 WALL UNIT WITH 2 GLASS DOORS AND 2 PERFORATED DOORS W 120 H 120	2.393
1	PFC2171K PENSILE ORIZZONTALE VASISTAS ANTA VETRO L 180 HORIZONTAL WALL UNIT WITH GLASS LIFT-UP DOOR W 180	1.521
1	PFC3531K MENSOLA L 180 SHELF W 180	386
PFC0108K PREZZO TOTALE COMPOSIZIONE TOTAL PRICE FOR COMPOSITION		7.464

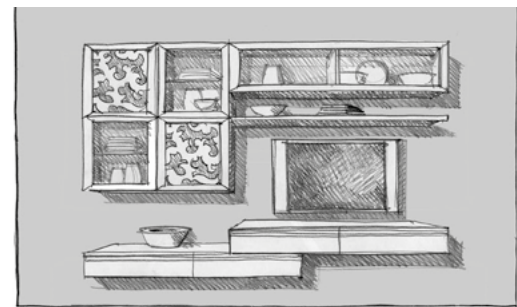

L. W. 300
P. D. 40

COMPOSIZIONI A CATALOGO CATALOGUE COMPOSITIONS

POSSIBILITÀ DI FRONTALE DIVERSO DALLA SCOCCA, SPECIFICARE LA FINITURA SCELTA
IN CASE OF FRONT DIFFERENT FROM THE CARCASE CONSIDER THE HIGHER PRICE OF THE CHOOSEN FINISH

COMPOSIZIONE 108/A COMPOSITION 108/A

PAG. 78-79 CATALOGO "MODOZINE"
PAGE 78-79 "MODOZINE" CATALOGUE

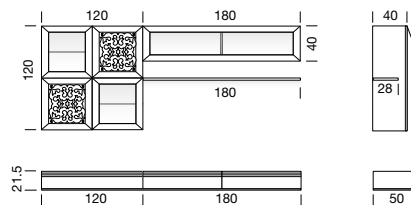
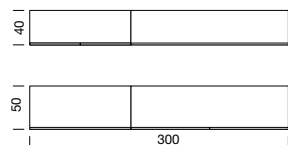

		NOCE FRASSINO
1	PFC1041K BASE A TERRA CON CASSETTO L 120 P 50 FLOOR-STANDING BASE UNIT WITH 1 DRAWER W 120 D 50	1.143
1	PFC1061K BASE A TERRA CON 2 CASSETTI L 180 P 50 FLOOR-STANDING BASE UNIT WITH 1 DRAWER W 180 D 50	1.630
1	PFC2881K PENSILE 2 ANTE VETRO 2 ANTE TRAFORATE L 120 H 120 WALL UNIT WITH 2 GLASS DOORS AND 2 PERFORATED DOORS W 120 H 120	2.393
1	PFC2171K PENSILE ORIZZONTALE ANTA VETRO VASISTAS L 180 HORIZONTAL WALL UNIT WITH GLASS LIFT-UP DOOR W 180	1.521
1	PFC3531K MENSOLA L 180 SHELF W 180	386
PFC108AK PREZZO TOTALE COMPOSIZIONE TOTAL PRICE FOR COMPOSITION		7.073



L. W. 300
P. D. 40/50

COMPOSIZIONE 108/B COMPOSITION 108/A

PAG. 76-77 CATALOGO "PORTOFINO NEW"
PAGE 76-77 "PORTOFINO NEW" CATALOGUE

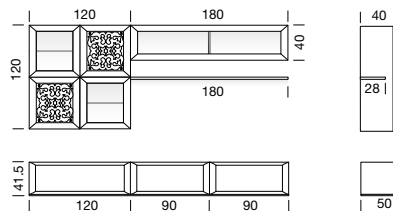
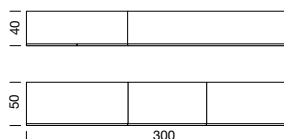

		NOCE FRASSINO
1	PFC1181K BASE A TERRA CON CESTONE L 120 P 50 FLOOR-STANDING BASE UNIT WITH BASKET W 120 D 50	1.365
2	PFC1161K BASE A TERRA CON CESTONE L 90 P 50 FLOOR-STANDING BASE UNIT WITH BASKET W 90 D 50	2.320
1	PFC2881K PENSILE 2 ANTE VETRO 2 ANTE TRAFORATE L 120 H 120 WALL UNIT WITH 2 GLASS DOORS AND 2 PERFORATED DOORS W 120 H 120	2.393
1	PFC2171K PENSILE ORIZZONTALE ANTA VETRO VASISTAS L 180 HORIZONTAL WALL UNIT WITH GLASS LIFT-UP DOOR W 180	1.521
1	PFC3531K MENSOLA L 180 SHELF W 180	386
PFC108BK PREZZO TOTALE COMPOSIZIONE TOTAL PRICE FOR COMPOSITION		7.985



L. W. 300
P. D. 40/50

PORTOFINO SISTEMA PARETE

PORTOFINO WALL SYSTEM

CARATTERISTICHE TECNICHE E PARTICOLARITÀ DI UTILIZZO TECHNICAL CHARACTERISTICS AND PARTICULAR USE	206
ACCESSORI OPTIONAL OPTIONAL ACCESSORIES	210
COMPONENTI STRUTTURALI STRUCTURAL COMPONENTS	211
FRONTALI PORTOFINO PORTOFINO FRONTS	215
MODULI A COLONNA H. 226.5 – P. 40 TALL UNIT MODULES H. 226.5 – D. 40	216
COMPOSIZIONI HOME THEATRE H. 226.5 – P. 40/50 HOME THEATRE COMPOSITIONS H. 226.5 – D. 40/50	226
COMPOSIZIONI A CATALOGO CATALOGUE COMPOSITIONS	228

PORTOFINO SISTEMA PARETE - WALL SYSTEM

CARATTERISTICHE TECNICHE E PARTICOLARITÀ DI UTILIZZO

TECHNICAL CHARACTERISTICS AND PARTICULAR USE

ANTE DOORS

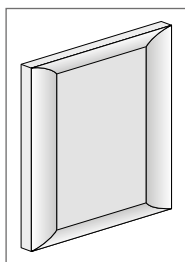

ANTA LEGNO
WOODEN DOOR

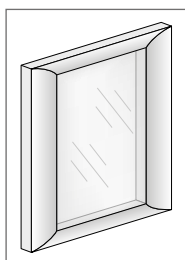

ANTA VETRO
GLASS DOOR

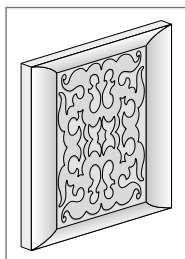

ANTA TRAFORATA
PERFORATED DOOR

ANTA LEGNO MASSELLO DI TOULUPIER O FRASSINO SPAZZOLATO SP. CM. 3 E PANNELLO IN MULTISTRATO IMPIALLACCIATO NOCE O FRASSINO SPAZZOLATO SP. CM.0.8 VERNICIATO O LACCATO A PORO APERTO.

MANIGLIA PUSH-PULL, POMOLO O CUORE IN FINITURA NICHEL LUCIDO.

CERNIERE AMMORTIZZATE DI SERIE

WOODEN DOOR TOULUPIER SOLID WOOD OR BRUSHED ASHWOOD TH. CM. 3 AND MULTILAYER PANEL VENEERED IN WALNUT OR BRUSHED ASHWOOD TH. CM.0.8 PAINTED OR OPEN PORE LACQUERED.

HANDLE PUSH-PULL, KNOB OR CUORE IN GLOSSY NICKEL FINISH.

STANDARD SOFT-CLOSE HINGES

ANTA VETRO MASSELLO DI TOULUPIER O FRASSINO SPAZZOLATO SP. CM.3 E VETRO FLOAT SPESSORE CM.0.4, VERNICIATO O LACCATO A PORO APERTO.

MANIGLIA PUSH-PULL, POMOLO O CUORE IN FINITURA NICHEL LUCIDO.

CERNIERE AMMORTIZZATE DI SERIE

GLASS DOOR TOULUPIER SOLID WOOD OR BRUSHED ASHWOOD TH. CM.3 AND FLOAT GLASS TH. CM.0.4, OPEN PORE LACQUERED OR PAINTED.

HANDLE PUSH-PULL, KNOB OR CUORE IN GLOSSY NICKEL FINISH.

STANDARD SOFT-CLOSE HINGES

ANTA TRAFORATA MASSELLO DI TOULUPIER O FRASSINO SPAZZOLATO SP. CM.3 E PANNELLO IN MULTISTRATO IMPIALLACCIATO IN NOCE O FRASSINO SPAZZOLATO SP. CM.0.8, VERNICIATO O LACCATO A PORO APERTO.

MANIGLIA PUSH-PULL, POMOLO O CUORE IN FINITURA NICHEL LUCIDO.

CERNIERE AMMORTIZZATE DI SERIE

PERFORATED DOOR TOULUPIER SOLID WOOD OR BRUSHED ASHWOOD TH. CM.3 AND MULTILAYER PANEL VENEERED IN WALNUT OR BRUSHED ASHWOOD TH. CM.0.8, OPEN PORE LACQUERED OR PAINTED.

HANDLE PUSH-PULL, KNOB OR CUORE IN GLOSSY NICKEL FINISH.

STANDARD SOFT-CLOSE HINGES

CASSETTI E CESTONI DRAWERS AND BASKETS

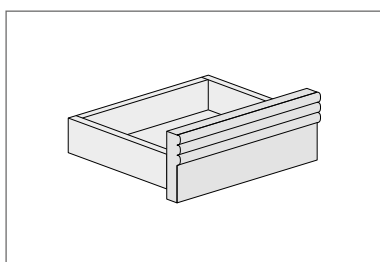

CASSETTO LEGNO
WOODEN DRAWER

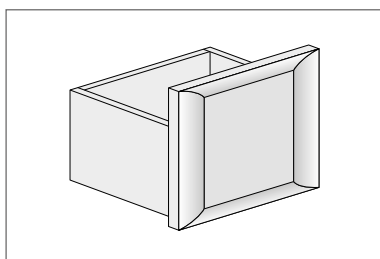

CESTONE LEGNO
WOODEN BASKET

FRONTALE CASSETTO MASSELLO DI TOULUPIER O FRASSINO SPAZZOLATO SP. CM. 3, VERNICIATO O LACCATO A PORO APERTO.

STRUTTURA CASSETTO PANNELLO DI MULTISTRATO BETULLA SP. CM.1.5 VERNICIATO TINTA ACACIA.

GUIDE CASSETTO REGOLABILI IN ALTEZZA E CON RICHIAMO AUTOMATICO AMMORTIZZATO

MANIGLIA CASSETTO PUSH-PULL O MANIGLIA MONDRIAN IN FINITURA ABBIANATA AL CASSETTO.

DRAWER FRONT TOULUPIER SOLID WOOD OR BRUSHED SOLID ASHWOOD TH. CM. 3, OPEN PORE LACQUERED OR PAINTED.

DRAWER STRUCTURE BIRCH MULTILAYER PANEL TH. CM.1.5 ACACIA STAINED PAINTED.

DRAWER GUIDES ADJUSTABLE IN HEIGHT AND SOFT-CLOSE SELF-CLOSING MECHANISM

DRAWER HANDLE PUSH-PULL OR MONDRIAN HANDLE IN THE SAME FINISH AS THE DRAWER.

FRONTALE CESTONE PANNELLO DI LISTELLARE IMPIALLACCIATO IN NOCE O FRASSINO SPAZZOLATO O SP. CM. 1.5 E CORNICE PERIMETRALE IN MASSELLO DI TOULUPIER O FRASSINO SPAZZOLATO SP. CM.3 VERNICIATO O LACCATO A PORO APERTO.

STRUTTURA CESTONE PANNELLO DI MULTISTRATO BETULLA SP. CM.1.5 VERNICIATO TINTA ACACIA.

GUIDE CASSETTO REGOLABILI IN ALTEZZA E CON RICHIAMO AUTOMATICO AMMORTIZZATO

MANIGLIA CESTONE PUSH-PULL, POMOLO, CUORE O RABBIT IN FINITURA NICHEL LUCIDO.

BASKET FRONT BLOCKBOARD PANEL VENEERED IN WALNUT OR BRUSHED ASHWOOD TH. CM. 1.5 AND PERIMETRIC FRAME IN TOULUPIER SOLID WOOD OR BRUSHED ASHWOOD TH. CM.3 OPEN PORE LACQUERED OR PAINTED.

BASKET STRUCTURE BIRCH MULTILAYER PANEL TH. CM.1.5 ACACIA STAINED PAINTED.

DRAWER GUIDES ADJUSTABLE IN HEIGHT AND SOFT-CLOSE SELF-CLOSING MECHANISM

BASKET HANDLE PUSH-PULL, KNOB, CUORE OR RABBIT IN GLOSSY NICKEL FINISH.

COMPONENTI PARETE A TERRA E IN APPOGGIO "HOME THEATRE" FLOOR-STANDING AND "HOME THEATRE" RAISED COMPONENTS

PARETE A TERRA FLOOR-STANDING PANEL

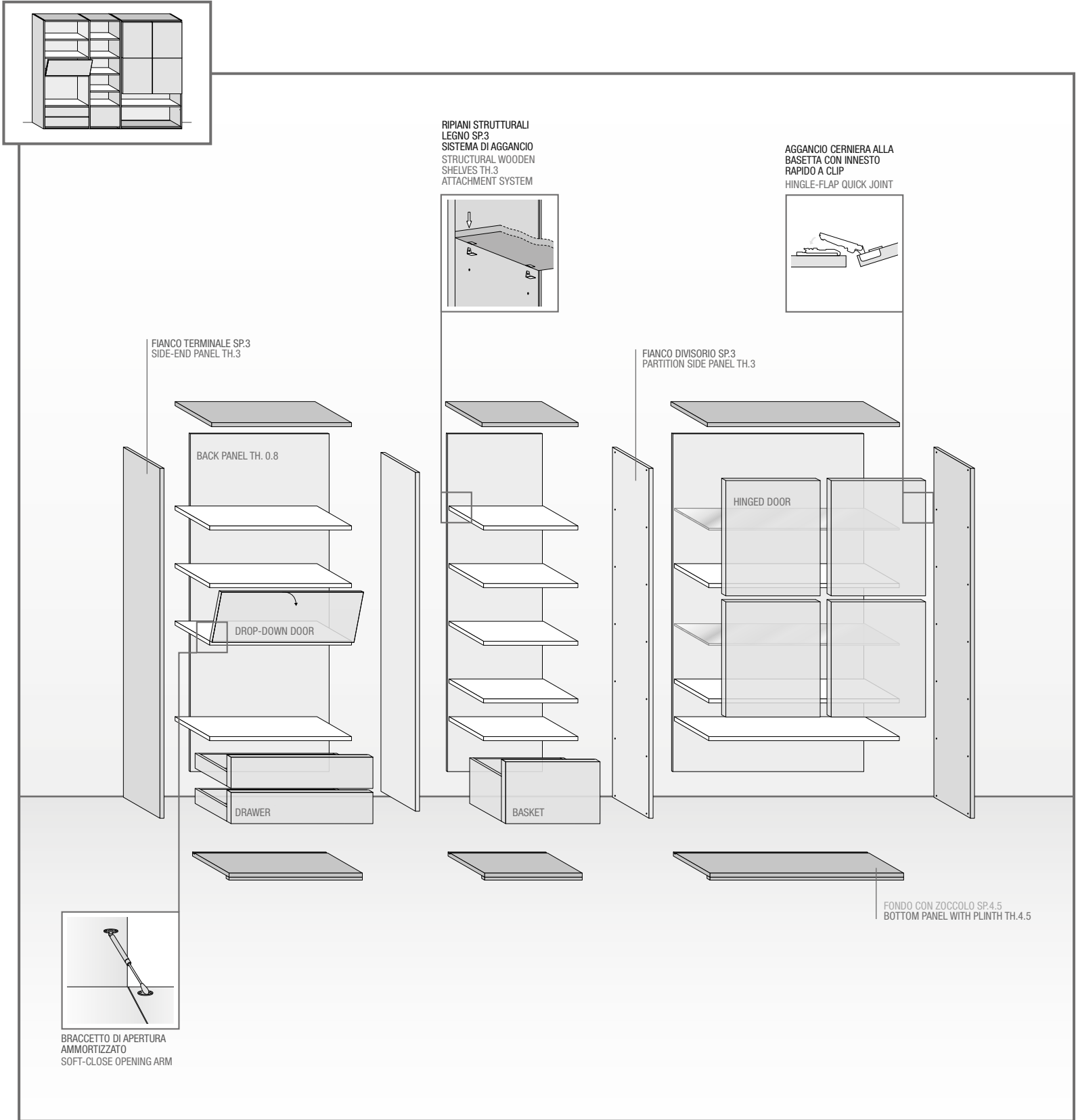

PORTOFINO SISTEMA PARETE - WALL SYSTEM

CARATTERISTICHE TECNICHE E PARTICOLARITÀ DI UTILIZZO

TECHNICAL CHARACTERISTICS AND PARTICULAR USE

ASSEMBLAGGIO PARETE

WALL ASSEMBLY

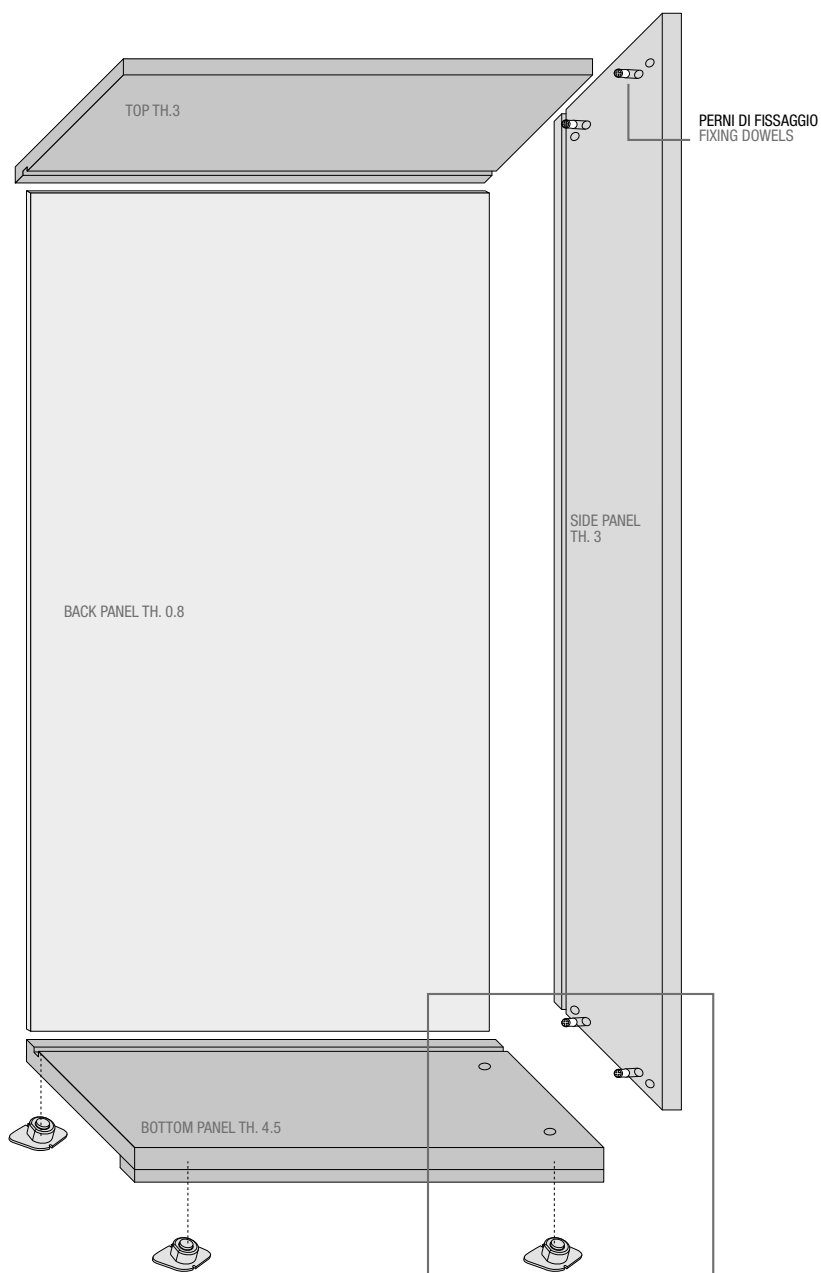

PIEDINO REGOLATORE CON BARILOTTO DI ASSEMBLAGGIO
ADJUSTABLE FOOT WITH ASSEMBLY BOLT

IL PIEDINO REGOLATORE HA DUE FUNZIONI IN UNA:
- LA PRIMA DI FISSAGGIO DEGLI ELEMENTI DELLA PARETE,
- LA SECONDA PER LA MESSA IN BOLLA.
È DOTATO DI ALETTA LATERALE PER IL SOSTEGNO DELLA SPALLA.

THE ADJUSTABLE FOOT HAS A DOUBLE FUNCTION:
- IT FIRST FASTENS THE WALL ELEMENTS
- SECONDLY IT IS USED FOR HEIGHT ADJUSTMENT.
IT IS PROVIDED WITH A SIDE FLAP TO SUPPORT THE END SIDE PANEL.

IL RIPIANO STRUTTURALE È IN LEGNO DA SP. 3. WOODEN STRUCTURAL SHELF TH. 3.

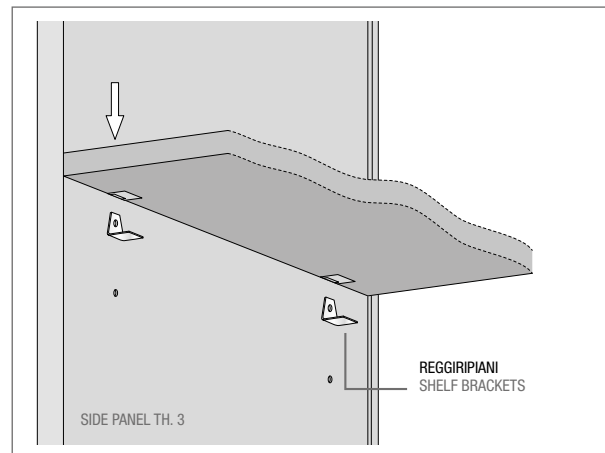

IL RIPIANO PORTAOGGETTI È IN VETRO DA SP. 0.8. GLASS SHELF TH. 0.8.

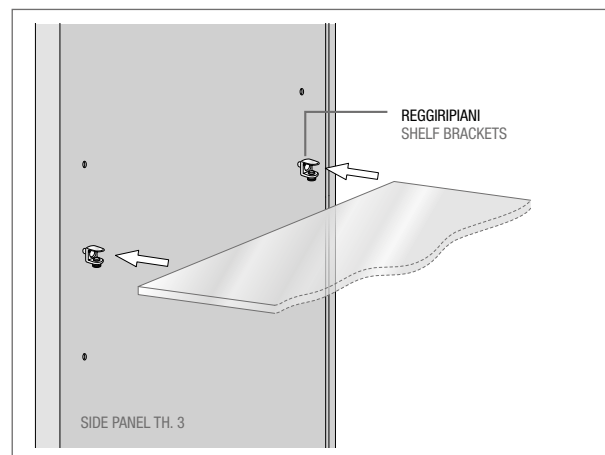

LE FORATURE DEI REGGIPIANI SONO PREDEFINITE IN BASE ALLA DISPOSIZIONE DEI VARI MODULI.
THE HOLES IN THE SHELF SUPPORTS DEPEND ON THE ARRANGEMENT OF THE MODULES.

PIEDINO REGOLATORE CON FUNZIONE DI AGGANCI CON IL PERNO DELLA SPALLA
ADJUSTABLE FOOT WITH ATTACHMENT FUNCTION WITH SUPPORT PANEL DOWEL

PIEDINO REGOLATORE CON FUNZIONE DI REGOLAZIONE DI LIVELLO
ADJUSTABLE FOOT WITH LEVELLING FUNCTION.

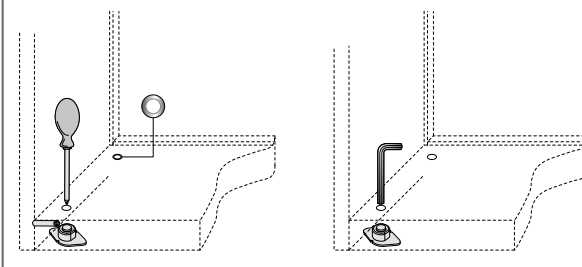

IL FORO SULLA BASE DEL PIEDINO HA UN ANELLO CROMATO DI FINITURA Ø CM. 0.8
HOLE ON BASE UNIT WITH FOOT HAS A FINISH CHROMED RING Ø CM. 0.8

**LO SCHIENALE VA INSERITO IN FRESATA SU BASE, COPERCHIO E FIANCO.
PER IL MONTAGGIO IN NICCHIA DELLA PARETE SONO NECESSARI CM. 3 IN LARGHEZZA E CM. 3 IN ALTEZZA.
THE BACK PANEL MUST BE FITTED INTO THE GROOVE OF THE BASE UNIT WITH PANEL, TOP AND SIDE PANEL.
FOR NICHE ASSEMBLY OF WALL CM. 3 IN WIDTH AND CM. 3 IN HEIGHT ARE NECESSARY.**

CARATTERISTICHE TECNICHE E PARTICOLARITÀ DI UTILIZZO

TECHNICAL CHARACTERISTICS AND PARTICULAR USE

SCHEMA DI UTILIZZO RIPIANI

HOW TO USE SHELVES

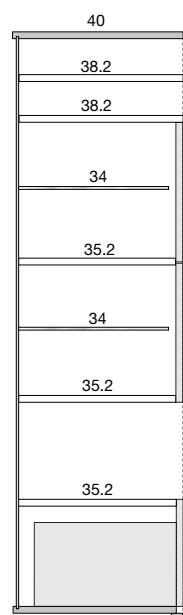

RIPIANI STRUTTURALI A GIORNO
SP. 3 - P. 38.2
OPEN STRUCTURAL SHELVES
TH. 3 - D. 38.2

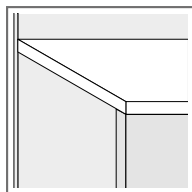

RIPIANI STRUTTURALI INTERNI
SP. 3 - P. 35.2
INTERNAL STRUCTURAL SHELVES
TH. 3 - D. 35.2

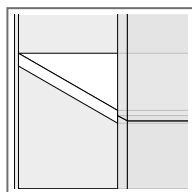

RIPIANI INTERNI PORTAOGGETTI
IN VETRO P. 34 - SP. 0.8
GLASS INTERNAL
SHELVES D. 34 - TH. 0.8

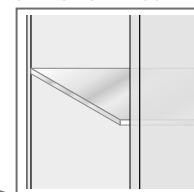

RIPIANI STRUTTURALI INTERNI
SP. 3 - P. 35.2
INTERNAL STRUCTURAL SHELVES
TH. 3 - D. 35.2

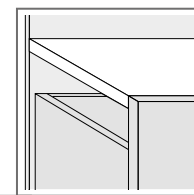

**IL RIPIANO LEGNO P. 38.2/35.2 VIENE UTILIZZATO SOLAMENTE COME RIPIANO STRUTTURALE.
IL RIPIANO VETRO VIENE UTILIZZATO SOLAMENTE COME RIPIANO INTERNO ALL'ANTA.
(È POSSIBILE METTERE IL RIPIANO LEGNO P. 34 - SP. 1.5 AL POSTO DEL VETRO, SOLO COME OPTIONAL)**
THE WOODEN SHELF D. 38.2/35.2 IS USED ONLY AS STRUCTURAL SHELF.
THE GLASS SHELF IS USED ONLY AS DOOR INSIDE SHELF.
(WOODEN SHELF IS POSSIBLE D. 34 - TH. 1.5 INSTEAD OF THE GLASS SHELF, ONLY AS AN OPTIONAL)

LIMITI DI UTILIZZO PER PENSILI VASISTAS E RIBALTA

USE LIMITS FOR WALL UNITS WITH LIFT-UP DOORS AND DROP-DOWN DOORS

PORTOFINO:
NON È POSSIBILE SOVRAPPORRE DUE PENSILI VASISTAS O DUE PENSILI RIBALTA
PORTOFINO:
IT IS NOT POSSIBLE TO STACK TWO WALL UNITS WITH LIFT-UP DOORS OR TWO
WALL UNITS WITH DROP-DOWN DOORS

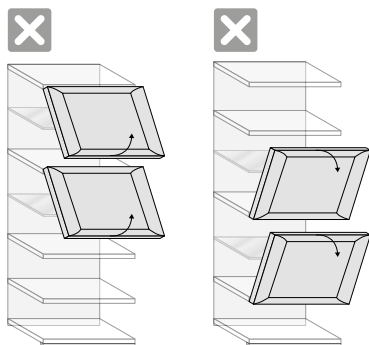

ALTEZZE MASSIME DI POSIZIONAMENTO ANTE VASISTAS/RIBALTA

MAXIMUM POSITION HEIGHTS FOR LIFT-UP/DROP-DOWN DOORS

ANTA VASISTAS
LIFT-UP DOOR

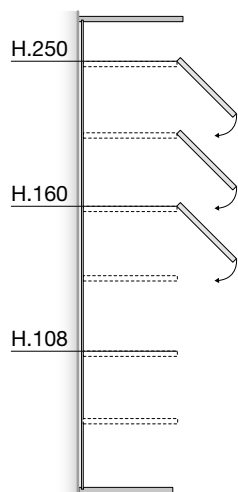

ANTA RIBALTA
DROP-DOWN DOOR

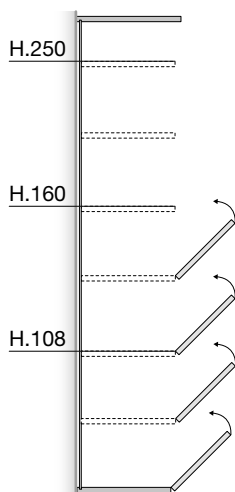

**POSIZIONAMENTO ANTE A RIBALTA DA H. 4.5 A H. 160
POSIZIONAMENTO ANTE A VASISTAS DA H. 160 A H. 250
POSITION OF DROP-DOWN DOORS H. 4.5 A H. 160
POSITION OF LIFT-UP DOORS FROM H. 160 TO H. 250**

PORTOFINO SISTEMA PARETE - WALL SYSTEM

ACCESSORI OPTIONAL OPTIONAL ACCESSORIES

**BARRA LED A BASSO CONSUMO
ACCENSIONE TOUCH
IN ALLUMINIO L. 37.2
COLLEGAMENTO
A CARICO DEL CLIENTE**

**LOW CONSUMPTION LED BAR
TOUCH SWITCH
IN ALUMINIUM W. 37.2
CONNECTIONS
TO BE MADE BY THE CUSTOMER.**



codice
code

ZZZFE22001

163

ALIMENTATORE POWER SUPPLY

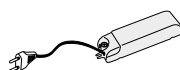

codice
code

ZZZFE22002

67

TELECOMANDO REMOTE CONTROL



codice
code

ZZZFE22004

158

**KIT SPORTELLINO PASSACAVI
+ BORCHIA
KIT FOR CABLE MANAGEMENT HOLE
+ COVER**

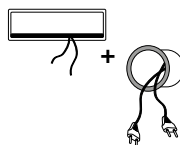

codice
code

ZZZFE22005

133

**MULTIPRESA A SCOMPARSA CON
SPORTELLINO APRI/CHIUDI IN
METALLO**

**CONCEALED MULTIPLE SOCKET
WITH METAL OPEN/CLOSE FLAP**

VERSIONE TV:
1 PRESA SCHUKO
2 PRESI USB RICARICA
1 PRESA SAT.
TV VERSION:
1 SCHUKO SOCKET
2 SOCKETS USB CHARGE
1 SAT. SOCKET



codice
code

ZZZFE22030

595

VERSIONE PC/MAC:
1 PRESA SCHUKO
2 PORTE USB DATI
1 PORTA HDMI
PC/MAC VERSION:
1 SCHUKO SOCKET
2 USB PORT
1 HDMI PORT



codice
code

ZZZFE22031

595

COMPONENTI STRUTTURALI STRUCTURAL COMPONENTS

FIANCHI A TERRA

P. 40 – SP. 3
FLOOR-STANDING
SIDE PANELS
D. 40 – TH. 3

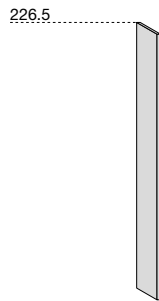

altezza height	codice code	NOCE-FRASSINO WALNUT-ASHWOOD	
226.5	PFP1031C	433	mc 0,04 – Kg 2

DIVISIONI A TERRA

P. 40 – SP. 3
FLOOR-STANDING
PARTITIONS
D. 40 – TH. 3

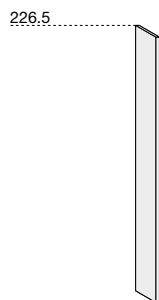

altezza height	codice code	NOCE-FRASSINO WALNUT-ASHWOOD	
226.5	PFP1071C	446	mc 0,04 – Kg 2

DIVISIONI VERTICALI

P. 38.2 – SP. 3
VERTICAL PARTITIONS
D. 38.2 – TH. 3

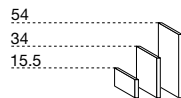

altezza height	codice code	NOCE-FRASSINO WALNUT-ASHWOOD	
15.5	PFP1311C	85	mc 0,01 – Kg 1
34	PFP1301C	127	mc 0,01 – Kg 2
54	PFP1321C	145	mc 0,02 – Kg 3

DIVISIONI IN APPOGGIO HOME THEATRE

P. 40 – SP. 3
RAISED PARTITIONS
HOME THEATRE
D. 40 – TH. 3

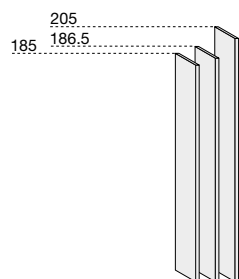

altezza height	codice code	NOCE-FRASSINO WALNUT-ASHWOOD	
185	PFP1251C	397	mc 0,02 – Kg 2
186.5	PFP1261C	397	mc 0,02 – Kg 2
205	PFP1271C	422	mc 0,03 – Kg 2

SCHIENALI A TERRA

226.5 – SP. 0.8
FLOOR-STANDING
BACK PANELS
226.5 – TH. 0.8

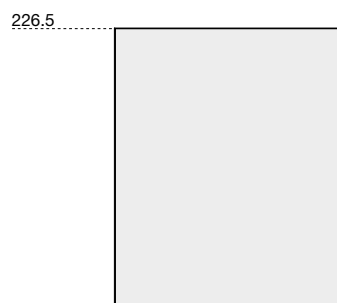

altezza height	larghezza width	codice code	NOCE-FRASSINO WALNUT-ASHWOOD	
226.5	34	PFP7111C	163	mc 0,08 – Kg 1,5
226.5	45	PFP7115C	241	mc 0,10 – Kg 1,5
226.5	60	PFP7231C	259	mc 0,14 – Kg 2
226.5	90	PFP7351C	374	mc 0,20 – Kg 2,5
226.5	120	PFP7711C	470	mc 0,27 – Kg 3,5
226.5	140	PFP8091C	584	mc 0,30 – Kg 4
226.5	180	PFP8071C	668	mc 0,40 – Kg 5

SCHIENALI IN APPOGGIO

H. 166.5/185/186.5/205 – SP. 0.8

RAISED BACK PANELS

H. 166.5/185/186.5/205 – TH. 0.8

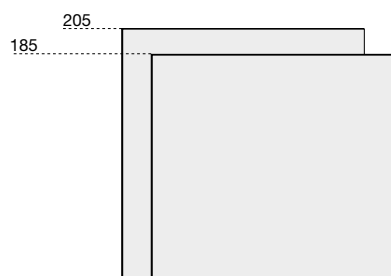

185	60	PFP7171C	229	mc 0,11 – Kg 2
185	90	PFP7301C	301	mc 0,16 – Kg 2,5
185	120	PFP7661C	404	mc 0,22 – Kg 3,5
185	140	PFP7781C	463	mc 0,26 – Kg 4
185	154	PFP7791C	518	mc 0,28 – Kg 4,5
185	180	PFP8021C	572	mc 0,33 – Kg 5
205	60	PFP7191C	247	mc 0,12 – Kg 2
205	90	PFP7331C	338	mc 0,18 – Kg 2,5
205	120	PFP7691C	446	mc 0,24 – Kg 3,5
205	140	PFP7811C	511	mc 0,28 – Kg 4
205	154	PFP7821C	577	mc 0,30 – Kg 4,5
205	180	PFP8051C	625	mc 0,36 – Kg 5

COPERCHI

P. 40 – SP. 3

TOPS

D. 40 – TH. 3

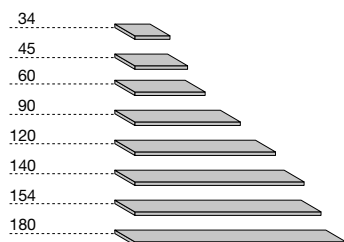

larghezza width	codice code	NOCE-FRASSINO WALNUT-ASHWOOD	
34	PFP3021C	102	mc 0,01 – Kg 0,5
45	PFP3401C	127	mc 0,02 – Kg 1
60	PFP3031C	145	mc 0,02 – Kg 1
90	PFP3041C	193	mc 0,02 – Kg 1,5
120	PFP3071C	235	mc 0,02 – Kg 2,5
140	PFP3081C	289	mc 0,03 – Kg 3
154	PFP3091C	318	mc 0,05 – Kg 3,5
180	PFP3101C	343	mc 0,03 – Kg 4

FONDI CON ZOCCOLO

P. 40 – SP. 4.5

BOTTOM PANELS WITH PLINTH

D. 40 – TH. 4.5

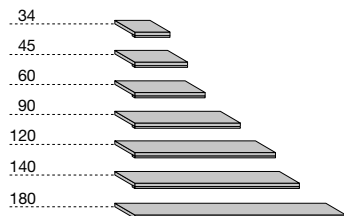

larghezza width	codice code	NOCE-FRASSINO WALNUT-ASHWOOD	
34	PFP2501C	127	mc 0,01 – Kg 0,5
45	PFP2551C	145	mc 0,02 – Kg 1
60	PFP2511C	163	mc 0,02 – Kg 1
90	PFP2521C	198	mc 0,02 – Kg 1,5
120	PFP2531C	247	mc 0,02 – Kg 2,5
140	PFP2561C	301	mc 0,03 – Kg 3
180	PFP2541C	349	mc 0,03 – Kg 4

FONDI INTERNI CON ZOCCOLO

P. 37 – SP. 4.5

INTERNAL BOTTOM PANELS WITH PLINTH

D. 37 – TH. 4.5

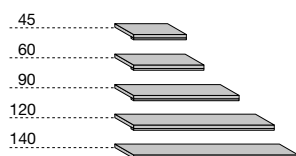

larghezza width	codice code	NOCE-FRASSINO WALNUT-ASHWOOD	
45	PFP2731C	145	mc 0,01 – Kg 0,5
60	PFP2701C	163	mc 0,02 – Kg 1
90	PFP2711C	198	mc 0,02 – Kg 1
120	PFP2721C	247	mc 0,02 – Kg 1,5
140	PFP2741C	301	mc 0,02 – Kg 2,5

COMPONENTI STRUTTURALI STRUCTURAL COMPONENTS

RIPIANI A GIORNO

P. 38.2 – SP. 3

OPEN SHELVES

D. 38.2 – TH. 3

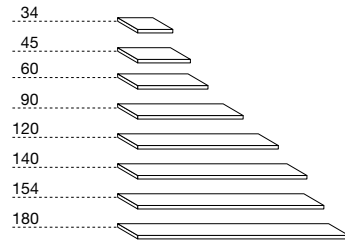

larghezza width	codice code	NOCE-FRASSINO WALNUT-ASHWOOD	
34	PFP2001C	102	mc 0,01 – Kg 0,5
45	PFP2141C	127	mc 0,02 – Kg 1
60	PFP2011C	145	mc 0,02 – Kg 1
90	PFP2021C	193	mc 0,02 – Kg 1,5
120	PFP2051C	235	mc 0,02 – Kg 2,5
140	PFP2061C	289	mc 0,03 – Kg 3
154	PFP2071C	318	mc 0,03 – Kg 3,5
180	PFP2081C	343	mc 0,03 – Kg 4

RIPIANI INTERNI

P. 35.2 – SP. 3

INTERNAL SHELVES

D. 35.2 – TH. 3

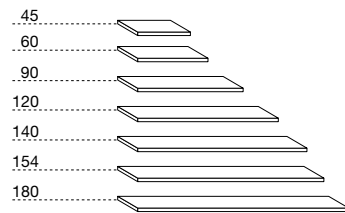

larghezza width	codice code	NOCE-FRASSINO WALNUT-ASHWOOD	
45	PFP2151C	127	mc 0,01 – Kg 0,5
60	PFP2101C	145	mc 0,02 – Kg 1
90	PFP2111C	193	mc 0,02 – Kg 1
120	PFP2121C	235	mc 0,02 – Kg 1,5
140	PFP2131C	289	mc 0,02 – Kg 2,5
154	PFP2171C	318	mc 0,03 – Kg 3
180	PFP2161C	343	mc 0,03 – Kg 4

RIPIANI INTERNI PORTAOGGETTI

P. 34 – SP. 1.5

INTERNAL SHELVES

D. 34 – TH. 1.5

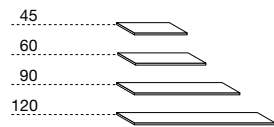

larghezza width	codice code	NOCE-FRASSINO WALNUT-ASHWOOD	
45	PFP2221C	97	mc 0,01 – Kg 0,5
60	PFP2231C	120	mc 0,01 – Kg 1
90	PFP2241C	163	mc 0,01 – Kg 1
120	PFP2251C	187	mc 0,01 – Kg 1,5

RIPIANI INTERNI IN VETRO

P. 34 – SP. 0.8

INTERNAL GLASS SHELVES

D. 34 – TH. 0.8



larghezza width	codice code	NOCE-FRASSINO WALNUT-ASHWOOD	
45	PFP2204C	43	mc 0,01 – Kg 0,5
60	PFP2201C	49	mc 0,01 – Kg 1
90	PFP2202C	61	mc 0,01 – Kg 1
120	PFP2203C	72	mc 0,01 – Kg 1,5

PORTOFINO SISTEMA PARETE - WALL SYSTEM

COMPONENTI STRUTTURALI STRUCTURAL COMPONENTS

PANNELLI PORTA TV

H. 95.5/126.5/145 – SP .1.5

TV PANELS

H. 95.5/126.5/145 – TH.1.5

★ NECESSARIO PER APPENDERE LA TV ALLO SCHIENALE
NEEDED TO HANG THE TV ON THE BACKREST

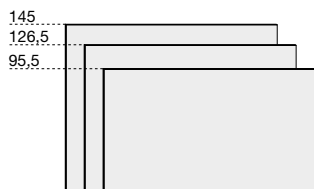

altezza height	larghezza width	codice code	NOCE-FRASSINO WALNUT-ASHWOOD	
95,5	120	PFP6641K	366	mc 0,03 – Kg 3,5
95,5	140	PFP6651K	415	mc 0,03 – Kg 4
95,5	154	PFP6661K	457	mc 0,03 – Kg 4,5
95,5	180	PFP6671K	500	mc 0,04 – Kg 5
126,5	120	PFP6781K	422	mc 0,03 – Kg 3,5
126,5	140	PFP6791K	500	mc 0,04 – Kg 4
126,5	154	PFP6801K	584	mc 0,04 – Kg 4,5
126,5	180	PFP6811K	602	mc 0,04 – Kg 5
145	120	PFP6851K	457	mc 0,04 – Kg 3,5
145	140	PFP6861K	542	mc 0,04 – Kg 4
145	154	PFP6871K	590	mc 0,04 – Kg 4,5
145	180	PFP6881K	638	mc 0,05 – Kg 5

CORNICI PERIMETRALI

H. 228

PER PARETI A TERRA H. 226.5

PERIMETRIC FRAMES

H. 228

FOR FLOOR-STANDING WALLS

H. 226.5

★ PARTE SUPERIORE IN 2 PEZZI
TOP PART IN 2 PIECES

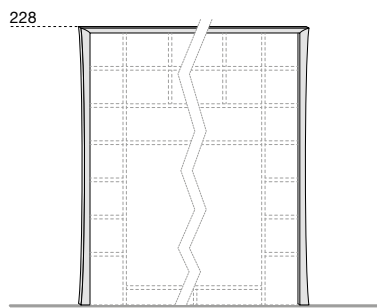

altezza height	larghezza width	codice code	NOCE-FRASSINO WALNUT-ASHWOOD	
228	max 105	PFP9151K	259	mc 0,05 – Kg 2,5
228	106÷225	PFP9161K	283	mc 0,05 – Kg 3
228	226÷355	PFP9171K	331	mc 0,05 – Kg 3,5
228	356÷455	PFP9181K	366	mc 0,05 – Kg 4
228	456÷555	PFP9191K	391	mc 0,05 – Kg 4,5

INGOMBRI CORNICE PERIMETRALE DIMENSIONS FOR PERIMETRIC FRAME

VISTA IN PIANTA
LAYOUT VIEW

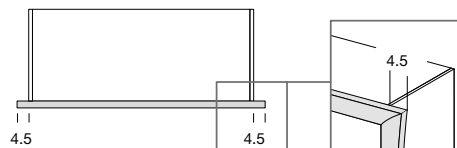

VISTA LATERALE
SIDE VIEW

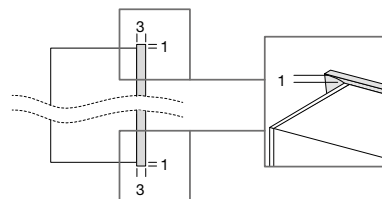

CASSETTI H. 20 PORTOFINO

DRAWERS H. 20 PORTOFINO

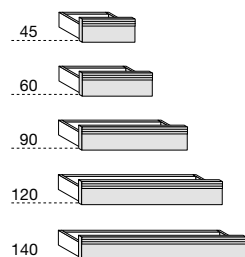

larghezza width	codice code	NOCE-FRASSINO WALNUT-ASHWOOD	
45	PFP4031C	308	mc 0,05 – Kg 4,5
60	PFP4001C	313	mc 0,06 – Kg 6
90	PFP4011C	349	mc 0,08 – Kg 9
120	PFP4021C	404	mc 0,12 – Kg 12
140	PFP4041C	446	mc 0,14 – Kg 14

CESTONI H. 40 PORTOFINO

BASKETS H. 40 PORTOFINO

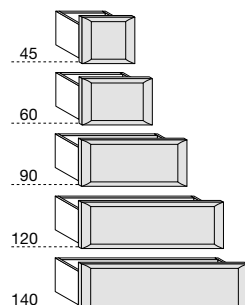

larghezza width	codice code	NOCE-FRASSINO WALNUT-ASHWOOD	
45	PFP4231C	457	mc 0,08 – Kg 9
60	PFP4201C	470	mc 0,12 – Kg 12
90	PFP4211C	511	mc 0,17 – Kg 18
120	PFP4221C	567	mc 0,23 – Kg 24
140	PFP4241C	674	mc 0,27 – Kg 28

FRONTALI PORTOFINO PORTOFINO FRONTS

ANTE LEGNO PORTOFINO PORTOFINO WOODEN DOORS

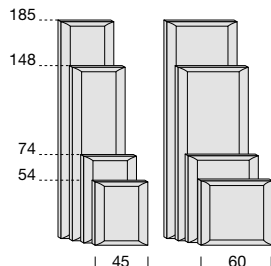

altezza height	larghezza width	codice dx code rh	codice sx code lh	NOCE-FRASSINO WALNUT-ASHWOOD	
54	45	PFP5481C	PFP5482C	247	mc 0,02 – Kg 4
54	60	PFP5401C	PFP5402C	259	mc 0,02 – Kg 5
74	45	PFP5501C	PFP5502C	283	mc 0,02 – Kg 5
74	60	PFP5421C	PFP5422C	289	mc 0,02 – Kg 7
148	45	PFP5521C	PFP5522C	422	mc 0,03 – Kg 10
148	60	PFP5441C	PFP5442C	452	mc 0,03 – Kg 14
185	45	PFP5541C	PFP5542C	494	mc 0,03 – Kg 13
185	60	PFP5461C	PFP5462C	524	mc 0,04 – Kg 17

ANTE VETRO PORTOFINO PORTOFINO GLASS DOORS

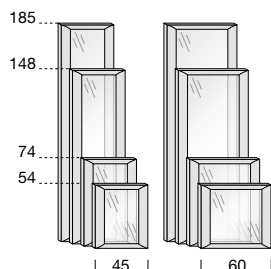

altezza height	larghezza width	codice dx code rh	codice sx code lh	NOCE-FRASSINO WALNUT-ASHWOOD	
54	45	PFP5641C	PFP5642C	247	mc 0,02 – Kg 4
54	60	PFP5561C	PFP5562C	259	mc 0,02 – Kg 5
74	45	PFP5661C	PFP5662C	283	mc 0,02 – Kg 5
74	60	PFP5581C	PFP5582C	289	mc 0,02 – Kg 7
148	45	PFP5681C	PFP5682C	422	mc 0,03 – Kg 10
148	60	PFP5601C	PFP5602C	452	mc 0,03 – Kg 14
185	45	PFP5701C	PFP5702C	494	mc 0,03 – Kg 13
185	60	PFP5621C	PFP5622C	524	mc 0,04 – Kg 17

ANTE TRAFORATE PORTOFINO PORTOFINO DECORATED DOORS

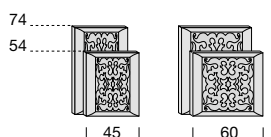

altezza height	larghezza width	codice dx code rh	codice sx code lh	NOCE-FRASSINO WALNUT-ASHWOOD	
54	45	PFP5485C	PFP5486C	386	mc 0,02 – Kg 4
54	60	PFP5405C	PFP5406C	409	mc 0,02 – Kg 5
74	45	PFP5505C	PFP5506C	422	mc 0,02 – Kg 5
74	60	PFP5425C	PFP5426C	457	mc 0,02 – Kg 7

ANTE LEGNO RIBALTA E VASISTAS PORTOFINO H. 37 PORTOFINO LIFT-UP AND WOODEN DROP-DOWN DOORS H. 37

PER LIMITI DI UTILIZZO DELLE ANTE
VASISTAS E RIBALTA CONSULTARE PAG. 296
FOR USE LIMITS OF LIFT-UP AND DROP-
DOWN DOORS SEE PAGE 296

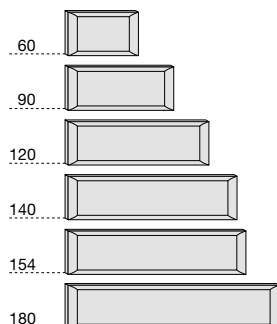

larghezza width	codice vasistas lift-up code	codice ribalta drop-down code	NOCE-FRASSINO WALNUT-ASHWOOD	
60	PFP5201C	PFP5001C	283	mc 0,02 – Kg 4
90	PFP5211C	PFP5011C	313	mc 0,02 – Kg 5
120	PFP5221C	PFP5021C	361	mc 0,02 – Kg 7
140	PFP5241C	PFP5251C	409	mc 0,02 – Kg 8
154	PFP5711C	PFP5731C	422	mc 0,03 – Kg 9
180	PFP5231C	PFP5031C	470	mc 0,03 – Kg 10

ANTE VETRO RIBALTA E VASISTAS PORTOFINO H. 37 PORTOFINO LIFT-UP AND GLASS DROP-DOWN DOORS H. 37

PER LIMITI DI UTILIZZO DELLE ANTE
VASISTAS E RIBALTA CONSULTARE PAG. 296
FOR USE LIMITS OF LIFT-UP AND DROP-
DOWN DOORS SEE PAGE 296

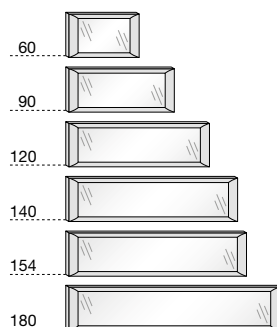

larghezza width	codice vasistas lift-up code	codice ribalta drop-down code	NOCE-FRASSINO WALNUT-ASHWOOD	
60	PFP5301C	PFP5101C	283	mc 0,02 – Kg 4
90	PFP5311C	PFP5111C	313	mc 0,02 – Kg 5
120	PFP5321C	PFP5121C	361	mc 0,02 – Kg 7
140	PFP5411C	PFP5451C	409	mc 0,02 – Kg 8
154	PFP5721C	PFP5741C	422	mc 0,03 – Kg 9
180	PFP5331C	PFP5131C	470	mc 0,03 – Kg 10

PORTOFINO SISTEMA PARETE - WALL SYSTEM

MODULI A COLONNA H. 226.5 – P. 40

TALL UNIT MODULES H. 226.5 – D. 40

MODULI A GIORNO OPEN MODULES

5 RIPIANI
5 SHELVES

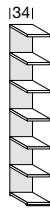

PFP5001M

5 RIPIANI
5 SHELVES

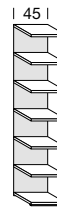

PFP5005M

5 RIPIANI
5 SHELVES

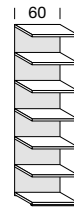

PFP5011M

NOCE-FRASSINO / WALNUT-ASHWOOD

861

1.070

1.221

5 RIPIANI
5 SHELVES

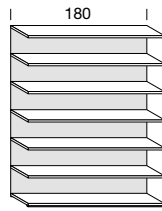

PFP5851M

3 RIPIANI
3 SHELVES

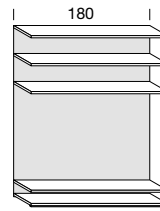

PFP5861M

5 RIPIANI ANGOLO
5 CORNER SHELVES

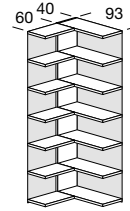

PFP6131M

NOCE-FRASSINO / WALNUT-ASHWOOD

2.360

2.345

3.289

MODULI L. 45 MODULES W. 45

1 ANTA LEGNO
1 WOODEN DOOR

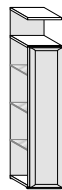

PFP5215M

1 ANTA VETRO
1 GLASS DOOR



PFP5235M

1 ANTA LEGNO, 1 RIPIANO
1 WOODEN DOOR, 1 SHELF

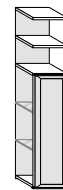

PFP5175M

NOCE-FRASSINO / WALNUT-ASHWOOD

1.191

1.191

1.203

1 ANTA LEGNO, 1 RIPIANO,
1 ANTA VETRO
1 WOODEN DOOR, 1 SHELF,
1 GLASS DOOR

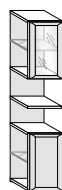

PFP5315M

1 ANTA LEGNO, 1 RIPIANO,
1 ANTA DECORATA/TRAFORATA
1 WOODEN DOOR, 1 SHELF,
1 DECORATED/PERFORATED DOOR

*



PFP5325M

2 CASSETTI, 1 ANTA VETRO, 1 ANTA DECORATA/
TRAFORATA
2 DRAWERS, 1 GLASS DOOR, 1 DECORATED/
PERFORATED DOOR

*



PFP5075M

NOCE-FRASSINO / WALNUT-ASHWOOD

1.456

1.593

2.242

N.B.: INDICARE SEMPRE IL VERSO DELL'ANTA (DX O SX)
N.B.: ALWAYS INDICATE THE DIRECTION OF DOOR (RH OR LH)

5 RIPIANI
5 SHELVES

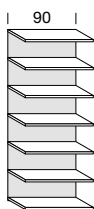

PFP5371M

1.684

5 RIPIANI
5 SHELVES

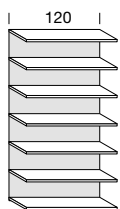

PFP5611M

2.062

5 RIPIANI
5 SHELVES

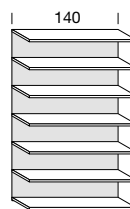

PFP6001M

2.579

EL. STRUTTURALI E OPTIONAL OPTIONAL AND STRUCTURAL EL.

FIANCO A TERRA SP. 3
FLOOR-STANDING SIDE PANEL TH. 3



PFP1031C

433

mc 0,04 - Kg 2

DIVISIONE A TERRA SP. 3
FLOOR-STANDING PARTITION TH. 3

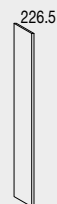

PFP1071C

446

mc 0,04 - Kg 2

BARRA LED A BASSO CONSUMO
ACCENSIONE TOUCH
IN ALLUMINIO L. 37.2
LOW CONSUMPTION LED BAR
TOUCH SWITCH
IN ALUMINIUM W. 37.2



ZZZFE22001

163

ALIMENTATORE
POWER SUPPLY



ZZZFE22002

67

COLLEGAMENTO
A CARICO DEL CLIENTE
CONNECTIONS
TO BE MADE BY THE CUSTOMER.

1 ANTA VETRO, 1 RIPIANO
1 GLASS DOOR, 1 SHELF

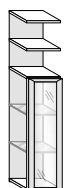

PFP5195M

1.203

2 ANTE LEGNO, 1 RIPIANO
2 WOODEN DOORS, 1 SHELF

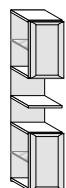

PFP5295M

1.456

2 ANTE DECORATE/TRAFORATE, 1 RIPIANO
2 DECORATED/PERFORATED DOORS, 1 SHELF

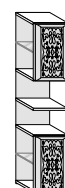

PFP5285M

1.737

*

2 CASSETTI, 2 ANTE VETRO
2 DRAWERS, 2 GLASS DOORS



PFP5275M

2.098

2 CASSETTI, 1 ANTA TRAFORATA,
1 ANTA LEGNO
2 DRAWERS, 1 PERFORATED DOOR,
1 WOODEN DOOR

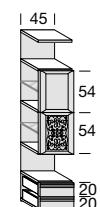

PFP5065M

2.242

POSSIBILITÀ DI FRONTALE DIVERSO
DALLA SCOCCA, SPECIFICARE LA
FINITURA SCELTA

IN CASE OF FRONT DIFERENT FROM
THE CARCASE CONSIDER THE
HIGHER PRICE OF THE CHOOSEN
FINISH

PORTOFINO SISTEMA PARETE - WALL SYSTEM

MODULI A COLONNA H. 226.5 – P. 40

TALL UNIT MODULES H. 226.5 – D. 40

MODULI L. 45 MODULES W. 45

1 CESTONE, 2 ANTE TRAFORATE
1 BASKET, 2 PERFORATED DOORS

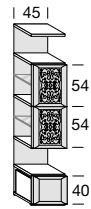

PFP5165M

Portofino

1 CESTONE, 1 ANTA VETRO,
1 ANTA LEGNO
1 BASKET, 1 GLASS DOOR,
1 WOODEN DOOR



PFP5085M

1 CESTONE, 1 ANTA TRAFORATA,
1 ANTA VETRO
1 BASKET, 1 PERFORATED DOOR,
1 GLASS DOOR

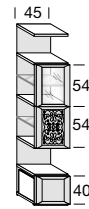

PFP5025M

NOCE-FRASSINO / WALNUT-ASHWOOD

2.225

1.948

2.087

MODULI L. 60 MODULES W. 60

1 ANTA LEGNO
1 WOODEN DOOR

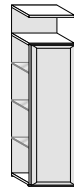

PFP5211M

1 ANTA VETRO
1 GLASS DOOR



PFP5231M

1 ANTA LEGNO, 1 RIPIANO
1 WOODEN DOOR, 1 SHELF

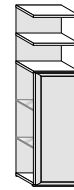

PFP5171M

NOCE-FRASSINO / WALNUT-ASHWOOD

1.323

1.323

1.341

1 CESTONE, 1 ANTA DECORATA/TRAFORATA
1 BASKET, 1 DECORATED/PERFORATED DOOR

*

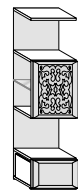

PFP5152M

2 ANTE LEGNO, 1 RIPIANO
2 WOODEN DOORS, 1 SHELF

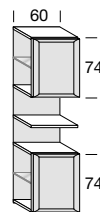

PFP5291M

2 ANTE DECORATE/TRAFORATE, 1 RIPIANO
2 DECORATED/PERFORATED DOORS, 1 SHELF

*

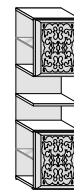

PFP5292M

NOCE-FRASSINO / WALNUT-ASHWOOD

1.900

1.593

1.930

2 CASSETTI, 2 ANTE VETRO
2 DRAWERS, 2 GLASS DOORS



PFP5271M

2 CASSETTI, 2 ANTE DECORATE/TRAFORATE
2 DRAWERS, 2 DECORATED/PERFORATED DOORS

*

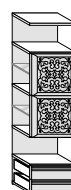

PFP5252M

2 CASSETTI, 1 ANTA VETRO,
1 ANTA LEGNO
2 DRAWERS, 1 GLASS DOOR,
1 WOODEN DOOR

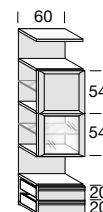

PFP5272M

NOCE-FRASSINO / WALNUT-ASHWOOD

2.285

2.597

2.285

N.B.: INDICARE SEMPRE IL VERSO DELL'ANTA (DX O SX)
N.B.: ALWAYS INDICATE THE DIRECTION OF DOOR (RH OR LH)

3 ANTE LEGNO
3 WOODEN DOORS

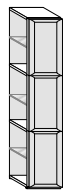

PFP5335M

1.648

2 ANTE LEGNO, 1 ANTA VETRO
2 WOODEN DOORS, 1 GLASS DOOR

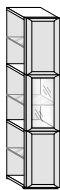

PFP5355M

1.648

1 ANTA VETRO, 1 RIPIANO
1 GLASS DOOR, 1 SHELF

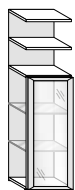

PFP5191M

1.341

1 CESTONE, 3 RIPIANI
1 BASKET, 3 SHELVES

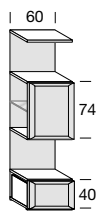

PFP5131M

1.737

1 CESTONE, 1 ANTA VETRO
1 BASKET, 1 GLASS DOOR

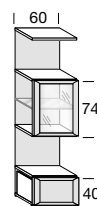

PFP5151M

1.737

1 ANTA LEGNO, 1 RIPIANO,
1 ANTA VETRO
1 WOODEN DOOR, 1 SHELF,
1 GLASS DOOR

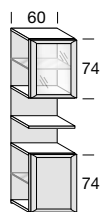

PFP5311M

1.593

1 ANTA LEGNO, 1 RIPIANO,
1 ANTA TRAFORATA
1 WOODEN DOOR, 1 SHELF,
1 PERFORATED DOOR

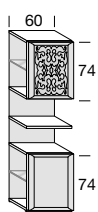

PFP5293M

1.762

2 CASSETTI, 2 ANTE LEGNO
2 DRAWERS, 2 WOODEN DOORS

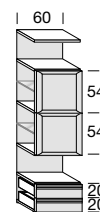

PFP5251M

2.285

2 CASSETTI, 1 ANTA DECORATA/TRAFORATA,
1 ANTA LEGNO
2 DRAWERS, 1 DECORATED/PERFORATED DOOR,
1 WOODEN DOOR

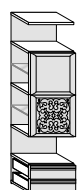

PFP5253M

2.435

2 CASSETTI, 1 ANTA DECORATA/TRAFORATA,
1 ANTA VETRO
2 DRAWERS, 1 DECORATED/PERFORATED DOOR,
1 GLASS DOOR

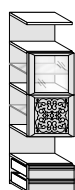

PFP5373M

2.435

1 CESTONE, 2 ANTE LEGNO
1 BASKET, 2 WOODEN DOORS

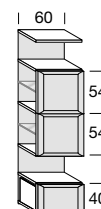

PFP5121M

2.134

EL. STRUTTURALI E OPTIONAL OPTIONAL AND STRUCTURAL EL.

FIANCO A TERRA SP. 3
FLOOR-STANDING SIDE PANEL TH. 3



PFP1031C

433

mc 0,04 – Kg 2

DIVISIONE A TERRA SP. 3
FLOOR-STANDING PARTITION TH. 3



PFP1071C

446

mc 0,04 – Kg 2

BARRA LED A BASSO CONSUMO
ACCENSIONE TOUCH
IN ALLUMINIO L. 37.2
LOW CONSUMPTION LED BAR
TOUCH SWITCH
IN ALUMINIUM W. 37.2



ZZZFE22001

163

ALIMENTATORE
POWER SUPPLY



ZZZFE22002

67

COLLEGAMENTO
A CARICO DEL CLIENTE
CONNECTIONS
TO BE MADE BY THE CUSTOMER.

POSSIBILITÀ DI FRONTALE DIVERSO
DALLA SCOCCA, SPECIFICARE LA
FINITURA SCELTA

IN CASE OF FRONT DIFERENT FROM
THE CARCASE CONSIDER THE
HIGHER PRICE OF THE CHOOSEN
FINISH

PORTOFINO SISTEMA PARETE - WALL SYSTEM

MODULI A COLONNA H. 226.5 – P. 40

TALL UNIT MODULES H. 226.5 – D. 40

MODULI L. 60
MODULES W. 60

1 CESTONE, 2 ANTE VETRO
1 BASKET, 2 GLASS DOORS

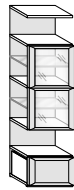

PFP5261M

1 CESTONE, 2 ANTE DECORATE/TRAFORATE
1 BASKET, 2 DECORATED/PERFORATED DOORS

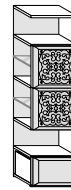

PFP5122M

1 CESTONE, 1 ANTA VETRO,
1 ANTA LEGNO
1 BASKET, 1 GLASS DOOR,
1 WOODEN DOOR

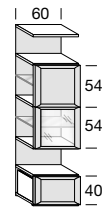

PFP5262M

NOCE-FRASSINO / WALNUT-ASHWOOD

2.134

*

2.562

2.134

1 CESTONE, 1 ANTA DECORATA/TRAFORATA,
1 ANTA LEGNO
1 BASKET, 1 DECORATED/PERFORATED DOOR,
1 WOODEN DOOR

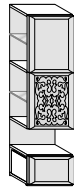

PFP5294M

3 ANTE LEGNO
3 WOODEN DOORS

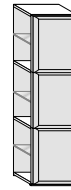

PFP5331M

3 ANTE DECORATE/TRAFORATE
3 DECORATED/PERFORATED DOORS

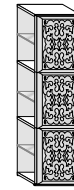

PFP5333M

NOCE-FRASSINO / WALNUT-ASHWOOD

2.225

*

1.780

2.285

*

MODULI L. 90
MODULES W. 90

2 ANTE LEGNO
2 WOODEN DOORS

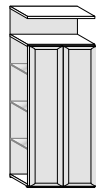

PFP5432M

2 ANTE VETRO
2 GLASS DOORS

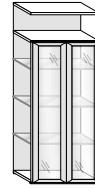

PFP5433M

1 CESTONE, 3 RIPIANI
1 BASKET, 3 SHELVES

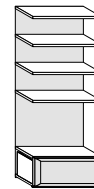

PFP5401M

NOCE-FRASSINO / WALNUT-ASHWOOD

1.973

1.973

2.009

1 CESTONE, 1 RIPIANO
1 VASISTAS VETRO
1 BASKET, 1 SHELF,
1 GLASS LIFT-UP DOOR

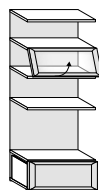

PFP5541M

2 ANTE LEGNO, 3 RIPIANI
2 WOODEN DOORS, 3 SHELVES

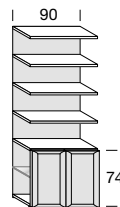

PFP7501M

2 ANTE TRAFORATE 3 RIPIANI
2 PERFORATED DOORS, 3 SHELVES

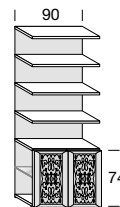

PFP7521M

NOCE-FRASSINO / WALNUT-ASHWOOD

2.314

2.105

2.387

N.B.: INDICARE SEMPRE IL VERSO DELL'ANTA (DX O SX)
N.B.: ALWAYS INDICATE THE DIRECTION OF DOOR (RH OR LH)

1 CESTONE, 1 ANTA TRAFORATA,
1 ANTA LEGNO
1 BASKET, 1 PERFORATED DOOR,
1 WOODEN DOOR

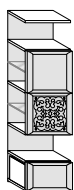

PFP5123M

2.285

1 CESTONE, 1 ANTA TRAFORATA,
1 ANTA VETRO
1 BASKET, 1 PERFORATED DOOR,
1 GLASS DOOR

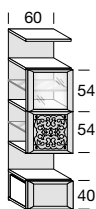

PFP5263M

2.285

2 ANTE LEGNO, 1 ANTA VETRO
2 WOODEN DOORS, 1 GLASS DOOR

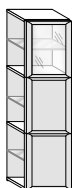

PFP5362M

1.780

2 CASSETTI, 1 RIPIANO,
1 VASISTAS LEGNO
2 DRAWERS, 1 SHELF,
1 WOODEN LIFT-UP DOOR

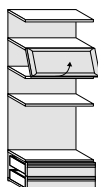

PFP5451M

2.489

2 CASSETTI, 1 RIPIANO,
1 VASISTAS VETRO
2 DRAWERS, 1 SHELF,
1 GLASS LIFT-UP DOOR

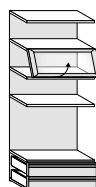

PFP5461M

2.489

1 CESTONE, 1 RIPIANO,
1 VASISTAS LEGNO
1 BASKET, 1 SHELF,
1 WOODEN LIFT-UP DOOR

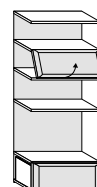

PFP5531M

2.314

4 ANTE LEGNO, 1 RIPIANO
4 WOODEN DOORS, 1 SHELF

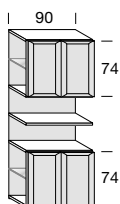

PFP5442M

2.519

2 ANTE LEGNO, 1 RIPIANO,
2 ANTE VETRO
2 WOODEN DOORS, 1 SHELF,
2 GLASS DOORS

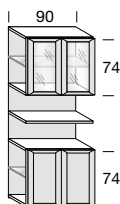

PFP5571M

2.519

4 ANTE LEGNO, 2 ANTE VETRO
4 WOODEN DOORS, 2 GLASS DOORS

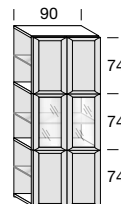

PFP5583M

2.940

EL. STRUTTURALI E OPTIONAL OPTIONAL AND STRUCTURAL EL.

FIANCO A TERRA SP. 3
FLOOR-STANDING SIDE PANEL TH. 3



PFP1031C

433

mc 0,04 – Kg 2

DIVISIONE A TERRA SP. 3
FLOOR-STANDING PARTITION TH. 3



PFP1071C

446

mc 0,04 – Kg 2

BARRA LED A BASSO CONSUMO
ACCENSIONE TOUCH
IN ALLUMINIO L. 37.2
LOW CONSUMPTION LED BAR
TOUCH SWITCH
IN ALUMINIUM W. 37.2



ZZZFE22001

163

ALIMENTATORE
POWER SUPPLY



ZZZFE22002

67

COLLEGAMENTO
A CARICO DEL CLIENTE
CONNECTIONS
TO BE MADE BY THE CUSTOMER.

POSSIBILITÀ DI FRONTALE DIVERSO
DALLA SCOCCA, SPECIFICARE LA
FINITURA SCELTA

IN CASE OF FRONT DIFERENT FROM
THE CARCASE CONSIDER THE
HIGHER PRICE OF THE CHOOSEN
FINISH

PORTOFINO SISTEMA PARETE - WALL SYSTEM

MODULI A COLONNA H. 226.5 – P. 40

TALL UNIT MODULES H. 226.5 – D. 40

MODULI L. 90 MODULES W. 90

2 ANTE LEGNO, 4 ANTE VETRO
2 WOODEN DOORS, 4 GLASS DOORS



PFP5581M

NOCE-FRASSINO / WALNUT-ASHWOOD **2.940**

4 ANTE LEGNO, 2 ANTE TRAFORATE
4 WOODEN DOORS, 2 PERFORATED DOORS

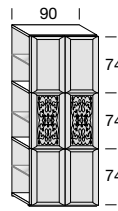

PFP5382M

NOCE-FRASSINO / WALNUT-ASHWOOD **3.222**

2 CASSETTI, 4 ANTE LEGNO
2 DRAWERS, 4 WOODEN DOORS

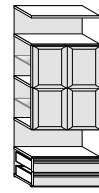

PFP5591M

NOCE-FRASSINO / WALNUT-ASHWOOD **3.240**

1 CESTONE, 2 ANTE LEGNO,
2 ANTE TRAFORATE
1 BASKET, 2 WOODEN DOORS,
2 PERFORATED DOORS

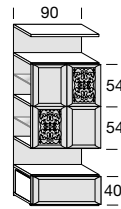

PFP5593M

NOCE-FRASSINO / WALNUT-ASHWOOD **3.349**

1 CESTONE, 2 ANTE VETRO,
2 ANTE TRAFORATE
1 BASKET, 2 GLASS DOORS,
2 PERFORATED DOORS

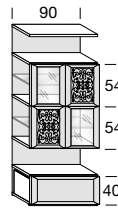

PFP5603M

NOCE-FRASSINO / WALNUT-ASHWOOD **3.349**

2 ANTE LEGNO, 1 RIBALTA LEGNO,
1 VASISTAS LEGNO
2 WOODEN DOORS, 1 WOODEN DROP-DOWN DOOR,
1 WOODEN LIFT-UP DOOR

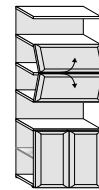

PFP5502M

NOCE-FRASSINO / WALNUT-ASHWOOD **2.723**

MODULI L. 120 MODULES W. 120

2 ANTE LEGNO
2 WOODEN DOORS

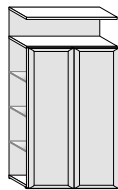

PFP7551M

NOCE-FRASSINO / WALNUT-ASHWOOD **2.393**

2 ANTE VETRO
2 GLASS DOORS

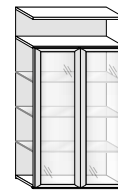

PFP7561M

NOCE-FRASSINO / WALNUT-ASHWOOD **2.393**

2 ANTE LEGNO, 1 RIPIANO
2 WOODEN DOORS, 1 SHELF

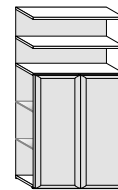

PFP7571M

NOCE-FRASSINO / WALNUT-ASHWOOD **2.399**

1 CESTONE, 2 RIPIANI
1 BASKET, 2 SHELVES

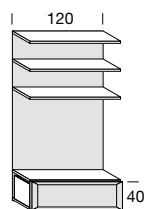

PFP5641M

NOCE-FRASSINO / WALNUT-ASHWOOD **2.170**

1 CESTONE, 1 VASISTAS LEGNO
1 BASKET, 1 WOODEN LIFT-UP DOOR

*

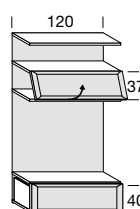

PFP5772M

NOCE-FRASSINO / WALNUT-ASHWOOD **2.519**

1 CESTONE, 1 VASISTAS VETRO
1 BASKET, 1 GLASS LIFT-UP DOOR

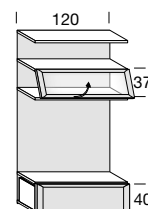

PFP5773M

NOCE-FRASSINO / WALNUT-ASHWOOD **2.519**

N.B.: INDICARE SEMPRE IL VERSO DELL'ANTA (DX O SX)
N.B.: ALWAYS INDICATE THE DIRECTION OF DOOR (RH OR LH)

2 CASSETTI, 4 ANTE VETRO
 2 DRAWERS, 4 GLASS DOORS

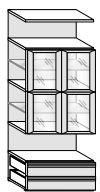

PFP5601M

3.240

1 CESTONE, 4 ANTE TRAFORATE
 1 BASKET, 4 PERFORATED DOORS

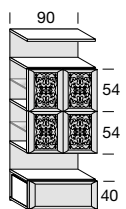

PFP5592M

3.631

1 CESTONE, 2 ANTE LEGNO,
 2 ANTE VETRO
 1 BASKET, 2 WOODEN DOORS,
 2 GLASS DOORS

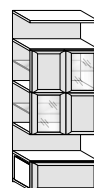

PFP5602M

3.060

1 CESTONE, 2 ANTE VETRO
 1 BASKET, 2 GLASS DOORS

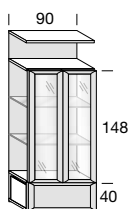

PFP7531M

2.573

2 ANTE VETRO, 1 RIPIANO
 2 GLASS DOORS, 1 SHELF

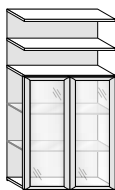

PFP7581M

2.399

2 ANTE VETRO, 1 VASISTAS LEGNO
 2 GLASS DOORS, 1 WOODEN LIFT-UP DOOR

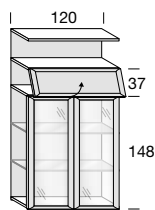

PFP9761M

2.723

1 CESTONE, 1 RIBALTA LEGNO,
 1 VASISTAS LEGNO
 1 BASKET, 1 WOODEN DROP-DOWN DOOR,
 1 WOODEN LIFT-UP DOOR

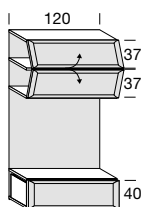

PFP5672M

2.880

1 CESTONE, 1 RIBALTA VETRO,
 1 VASISTAS LEGNO
 1 BASKET, 1 GLASS DROP-DOWN DOOR,
 1 WOODEN LIFT-UP DOOR

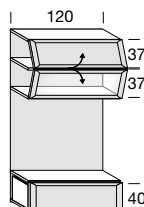

PFP5683M

2.880

1 CESTONE, 1 VASISTAS LEGNO, 1 RIPIANO
 1 BASKET, 1 WOODEN LIFT-UP DOOR, 1 SHELF

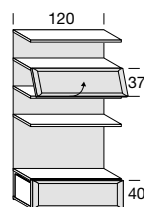

PFP7591M

2.747

EL. STRUTTURALI E OPTIONAL OPTIONAL AND STRUCTURAL EL.

FIANCO A TERRA SP. 3
 FLOOR-STANDING SIDE PANEL TH. 3



PFP1031C

433

mc 0,04 – Kg 2

DIVISIONE A TERRA SP. 3
 FLOOR-STANDING PARTITION TH. 3



PFP1071C

446

mc 0,04 – Kg 2

BARRA LED A BASSO CONSUMO
 ACCENSIONE TOUCH
 IN ALLUMINIO L. 37.2
 LOW CONSUMPTION LED BAR
 TOUCH SWITCH
 IN ALUMINIUM W. 37.2



ZZZFE22001

163

ALIMENTATORE
 POWER SUPPLY



ZZZFE22002

67

COLLEGAMENTO
 A CARICO DEL CLIENTE
 CONNECTIONS
 TO BE MADE BY THE CUSTOMER.

POSSIBILITÀ DI FRONTALE DIVERSO
 DALLA SCOCCA, SPECIFICARE LA
 FINITURA SCELTA

IN CASE OF FRONT DIFERENT FROM
 THE CARCASE CONSIDER THE
 HIGHER PRICE OF THE CHOOSEN
 FINISH

PORTOFINO SISTEMA PARETE - WALL SYSTEM

MODULI A COLONNA H. 226.5 – P. 40

TALL UNIT MODULES H. 226.5 – D. 40

MODULI L. 120 MODULES W. 120

1 CESTONE, 1 VASISTAS VETRO, 1 RIPIANO
1 BASKET, 1 GLASS LIFT-UP DOOR, 1 SHELF

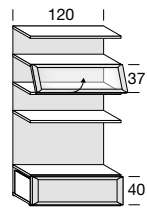

PFP7601M

NOCE-FRASSINO / WALNUT-ASHWOOD

2.747

4 ANTE LEGNO, 1 RIPIANO
4 WOODEN DOORS, 1 SHELF

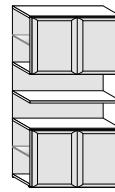

PFP5832M

2.867

2 ANTE LEGNO, 1 RIPIANO,
2 ANTE VETRO
2 WOODEN DOORS, 1 SHELF,
2 GLASS DOORS

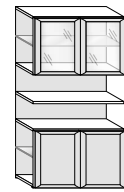

PFP5811M

2.867

6 ANTE VETRO
6 GLASS DOORS

*

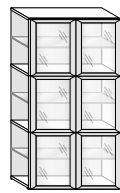

PFP5822M

NOCE-FRASSINO / WALNUT-ASHWOOD

3.276

4 ANTE LEGNO, 2 ANTE VETRO
4 WOODEN DOORS, 2 GLASS DOORS

*

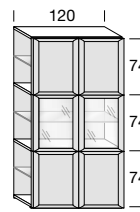

PFP5821M

3.276

4 ANTE LEGNO, 2 ANTE TRAFORATE
4 WOODEN DOORS, 2 PERFORATED DOORS

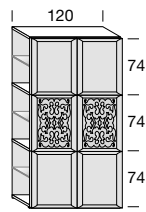

PFP5662M

3.607

1 CESTONE, 4 ANTE LEGNO
1 BASKET, 4 WOODEN DOORS

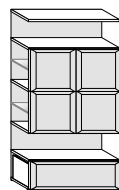

PFP5802M

NOCE-FRASSINO / WALNUT-ASHWOOD

3.529

1 CESTONE, 4 ANTE VETRO
1 BASKET, 4 GLASS DOORS

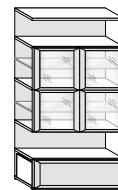

PFP5803M

3.529

1 CESTONE, 4 ANTE DECORATE/TRAFORATE
1 BASKET, 4 DECORATED/PERFORATED DOORS

*

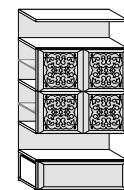

PFP5804M

4.141

MODULI TV L. 140 TV MODULES W. 140

1 CESTONE, 1 VASISTAS LEGNO
1 BASKET, 1 WOODEN LIFT-UP DOOR

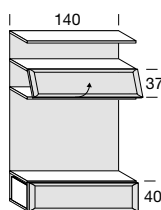

PFP7611M

NOCE-FRASSINO / WALNUT-ASHWOOD

3.121

1 CESTONE, 1 VASISTAS VETRO
1 BASKET, 1 GLASS LIFT-UP DOOR

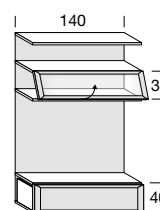

PFP7621M

3.078

1 CESTONE, 1 RIPIANO, 1 VASISTAS LEGNO
1 BASKET, 1 SHELF, 1 WOODEN LIFT-UP DOOR

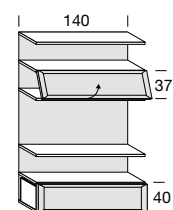

PFP4951M

3.367

N.B.: INDICARE SEMPRE IL VERSO DELL'ANTA (DX O SX)
N.B.: ALWAYS INDICATE THE DIRECTION OF DOOR (RH OR LH)

2 ANTE DECORATE/TRAFORATE, 1 RIPIANO,
 2 ANTE LEGNO
 2 DECORATED/PERFORATED DOORS, 1 SHELF,
 2 WOODEN DOORS

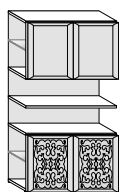

*

PFP5813M

3.204

2 ANTE DECORATE/TRAFORATE, 1 RIPIANO,
 2 ANTE VETRO
 2 DECORATED/PERFORATED DOORS, 1 SHELF,
 2 GLASS DOORS

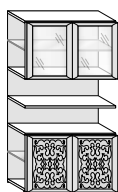

PFP5812M

3.204

6 ANTE LEGNO
 6 WOODEN DOORS

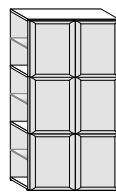

PFP5823M

3.276

EL. STRUTTURALI E OPTIONAL OPTIONAL AND STRUCTURAL EL.

FIANCO A TERRA SP. 3
 FLOOR-STANDING SIDE PANEL TH. 3



PFP1031C

433

mc 0,04 – Kg 2

DIVISIONE A TERRA SP. 3
 FLOOR-STANDING PARTITION TH. 3



PFP1071C

446

mc 0,04 – Kg 2

BARRA LED A BASSO CONSUMO
ACCENSIONE TOUCH
IN ALLUMINIO L. 37.2
LOW CONSUMPTION LED BAR
TOUCH SWITCH
IN ALUMINIUM W. 37.2



ZZZFE22001

163

ALIMENTATORE
POWER SUPPLY



ZZZFE22002

67

COLLEGAMENTO
A CARICO DEL CLIENTE
CONNECTIONS
TO BE MADE BY THE CUSTOMER.

1 CESTONE, 2 ANTE LEGNO,
 2 ANTE VETRO
 1 BASKET, 2 WOODEN DOORS,
 2 GLASS DOORS

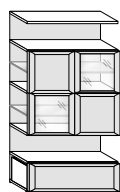

PFP5664M

3.529

1 CESTONE, 2 ANTE LEGNO,
 2 ANTE DECORATE/TRAFORATE
 1 BASKET, 2 WOODEN DOORS,
 2 DECORATED/PERFORATED DOORS

*

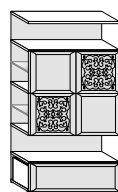

PFP5633M

3.836

1 CESTONE, 2 ANTE VETRO,
 2 ANTE DECORATE/TRAFORATE
 1 BASKET, 2 GLASS DOORS,
 2 DECORATED/PERFORATED DOORS

*

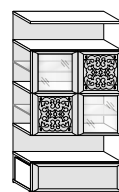

PFP5632M

3.836

1 CESTONE, 1 RIPIANO, 1 VASISTAS VETRO
 1 BASKET, 1 SHELF, 1 GLASS LIFT-UP DOOR

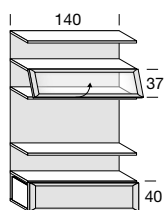

PFP4941M

3.367

POSSIBILITÀ DI FRONTALE DIVERSO
DALLA SCOCCA, SPECIFICARE LA
FINITURA SCELTA

IN CASE OF FRONT DIFERENT FROM
THE CARCASE CONSIDER THE
HIGHER PRICE OF THE CHOOSEN
FINISH

PORTOFINO SISTEMA PARETE - WALL SYSTEM

MODULI A COLONNA H. 226.5 – P. 40

TALL UNIT MODULES H. 226.5 – D. 40

MODULI L. 180
MODULES W. 180

2 CASSETTI, 2 RIPIANI
2 DRAWERS, 2 SHELVES

2 CESTONI, 2 RIPIANI
2 BASKETS, 2 SHELVES

2 CESTONI, 1 VASISTAS LEGNO
2 BASKETS, 1 WOODEN LIFT-UP DOOR

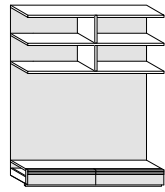

PFP1291M

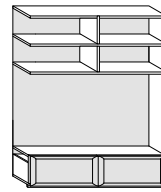

PFP1281M

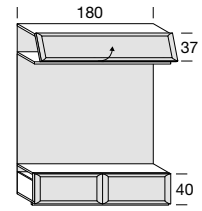

PFP7631M

NOCE-FRASSINO / WALNUT-ASHWOOD

3.259

3.588

3.487

COMPOSIZIONI HOME THEATRE H. 226.5 – P. 40/50

HOME THEATRE COMPOSITIONS H. 226.5 – D. 40/50

MODULI H. 226.5
MODULES H. 226.5

BASE 2 CESTONI, 1 ANTA VETRO,
1 VASISTAS VETRO, 1 LIBRERIA, 1 RIPIANO
BASE UNIT WITH 2 BASKETS, 1 GLASS DOOR,
1 GLASS LIFT-UP DOOR, 1 BOOKCASE, 1 SHELF

BASE 2 CESTONI, 1 ANTA VETRO, 1 RIBALTA VETRO, 1 VASISTAS LEGNO, 1 LIBRERIA

BASE UNIT WITH 2 BASKETS, 1 GLASS DOOR, 1 GLASS DROP-DOWN DOOR, 1 WOODEN
LIFT-UP DOOR, 1 BOOKCASE

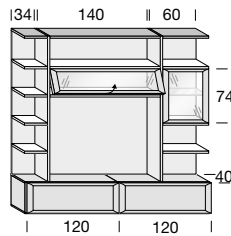

PFP1511M

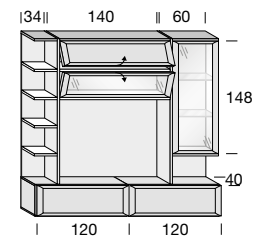

PFP1521M

NOCE-FRASSINO / WALNUT-ASHWOOD

6.823

7.160

BASE 2 CESTONI, 1 ANTA VETRO, 1 RIBALTA VETRO, 1 VASISTAS LEGNO, 1 LIBRERIA

BASE UNIT WITH 2 BASKETS, 1 GLASS DOOR, 1 GLASS DROP-DOWN DOOR, 1 WOODEN
LIFT-UP DOOR, 1 BOOKCASE

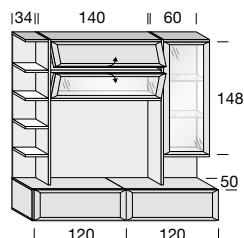

PFP1571M

NOCE-FRASSINO / WALNUT-ASHWOOD

7.250

N.B.: INDICARE SEMPRE IL VERSO DELL'ANTA (DX O SX)
N.B.: ALWAYS INDICATE THE DIRECTION OF DOOR (RH OR LH)

2 CESTONI, 1 VASISTAS VETRO
 2 BASKETS, 1 GLASS LIFT-UP DOOR

MODULO PONTE L. 180 OVERHEAD MODULE W. 180

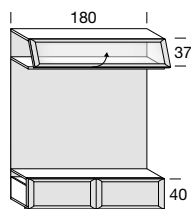

PFP7641M

Portofino

3.487

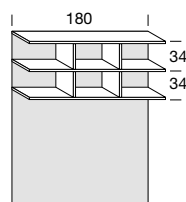

PFP9751M

2.026

NOCE-FRASSINO / WALNUT-ASHWOOD

BASE 2 CESTONI, 1 ANTA TRAFORATA, 1 LIBRERIA, 1 RIPIANO
 BASE UNIT WITH 2 BASKETS, 1 PERFORATED DOOR, 1 BOOKCASE, 1 SHELF

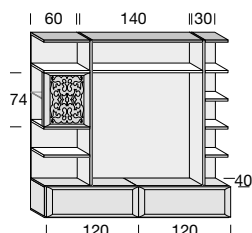

PFP1551M

6.300

BASE 2 CESTONI, 1 ANTA VETRO, 1 ANTA TRAFORATA, 1 VASISTAS VETRO, 1 LIBRERIA
 BASE UNIT WITH 2 BASKETS, 1 GLASS DOOR, 1 PERFORATED DOOR, 1 GLASS LIFT-UP DOOR, 1 BOOKCASE

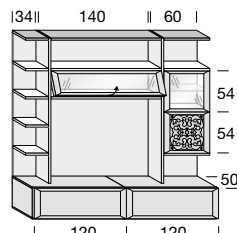

PFP1561M

7.323

EL. STRUTTURALI E OPTIONAL OPTIONAL AND STRUCTURAL EL.

FIANCO A TERRA SP. 3
 FLOOR-STANDING SIDE PANEL TH. 3



PFP1031C

433

mc 0,04 – Kg 2

DIVISIONE A TERRA SP. 3
 FLOOR-STANDING PARTITION TH. 3



PFP1071C

446

mc 0,04 – Kg 2

BARRA LED A BASSO CONSUMO
 ACCENSIONE TOUCH
 IN ALLUMINIO L. 37.2
 LOW CONSUMPTION LED BAR
 TOUCH SWITCH
 IN ALUMINIUM W. 37.2



ZZZFE22001

163

ALIMENTATORE
 POWER SUPPLY



ZZZFE22002

67

COLLEGAMENTO
 A CARICO DEL CLIENTE
 CONNECTIONS
 TO BE MADE BY THE CUSTOMER.

POSSIBILITÀ DI FRONTALE DIVERSO
 DALLA SCOCCA, SPECIFICARE LA
 FINITURA SCELTA

IN CASE OF FRONT DIFERENT FROM
 THE CARCASE CONSIDER THE
 HIGHER PRICE OF THE CHOOSE
 FINISH

PORTOFINO SISTEMA PARETE - WALL SYSTEM

COMPOSIZIONI A CATALOGO CATALOGUE COMPOSITIONS

POSSIBILITÀ DI FRONTALE DIVERSO DALLA SCOCCA, SPECIFICARE LA FINITURA SCELTA
IN CASE OF FRONT DIFFERENT FROM THE CARCASE CONSIDER THE HIGHER PRICE OF THE CHOOSEN FINISH

Per le composizioni a catalogo delle pareti Portofino: il prezzo di listino indicato è bloccato, applicabile solamente a composizioni come da foto/ disegno riportato.

Qualsiasi modifica delle composizioni proposte comporta l'annullamento di quanto sopra riportato; il prezzo deve essere calcolato sommando ogni singolo elemento.

The catalogue wall system compositions of Portofino: have a fixed price applicable only to compositions as shown in the photo or technical drawing.

Any modification of the proposed compositions entails the calculation of the price adding the price of all elements that compose it.

COMPOSIZIONE 256

COMPOSITION 256

PAG. 115 CATALOGO "PROPOSTE ARREDATIVE"
PAGE 115 "FURNISHING SOLUTIONS" CATALOGUE

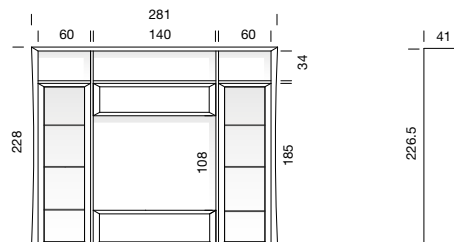
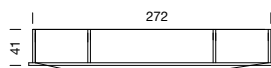

NOCE
FRASSINO

7.430

PFP0256K

PREZZO TOTALE COMPOSIZIONE
TOTAL PRICE FOR COMPOSITION

- 2 MODULO L 60 CON ANTA VETRO E VANO A GIORNO
MODULE W 60 WITH GLASS DOOR AND OPEN COMPARTMENT
- 1 MODULO L 140 CON CESTONE E ANTA VASISTAS VETRO
MODULE W 140 WITH BASKET AND GLASS LIFT-UP DOOR
- 2 DIVISIONE A TERRA H 226,5
FLOOR-STANDING PARTITION H 226,5
- 2 FIANCO A TERRA H 226,5
FLOOR-STANDING SIDE PANEL H 226,5
- 1 CORNICE PERIMETRALE H 228
PERIMETRIC FRAME H 228



L. W. 281
H. H. 228
P. D. 41

COMPOSIZIONE 258

COMPOSITION 258

PAG. 116 CATALOGO "PROPOSTE ARREDATIVE"
PAGE 116 "FURNISHING SOLUTIONS" CATALOGUE

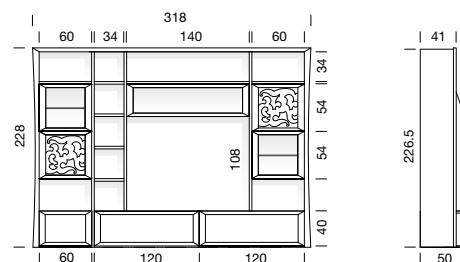
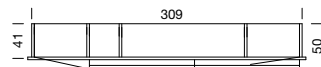

NOCE
FRASSINO

10.633

PFP0258K

PREZZO TOTALE COMPOSIZIONE
TOTAL PRICE FOR COMPOSITION

- 1 MODULO L 60 CON CESTONE, ANTA VETRO E ANTA TRAFORATA
MODULE W 60 WITH BASKET, GLASS DOOR AND PERFORATED DOOR
- 1 MODULO HOME THEATRE L 240 CON 2 BASI CESTONE, LIBRERIA, VASISTAS VETRO, ANTA TRAFORATA E ANTA VETRO
HOME THEATRE MODULE W 240 WITH 2 BASE UNITS WITH BASKET, BOOKCASE, GLASS LIFT-UP DOOR, PERFORATED DOOR AND GLAS DOOR
- 1 DIVISIONE A TERRA H 226,5
FLOOR-STANDING PARTITION H 226,5
- 2 FIANCO A TERRA H 226,5
FLOOR-STANDING SIDE PANEL H 226,5

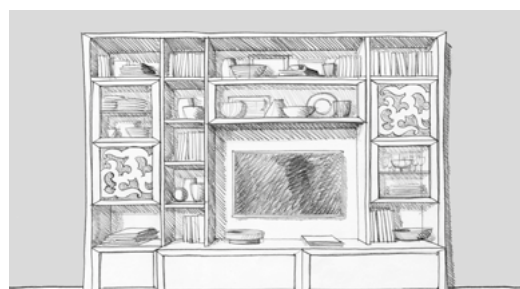

L. W. 318
H. H. 228
P. D. 41/50

COMPOSIZIONI A CATALOGO CATALOGUE COMPOSITIONS

POSSIBILITÀ DI FRONTALE DIVERSO DALLA SCOCCA, SPECIFICARE LA FINITURA SCELTA
IN CASE OF FRONT DIFFERENT FROM THE CARCASE CONSIDER THE HIGHER PRICE OF THE CHOOSEN FINISH

COMPOSIZIONE 260 COMPOSITION 260

PAG. 117 CATALOGO "PROPOSTE ARREDATIVE"
PAGE 117 "FURNISHING SOLUTIONS" CATALOGUE

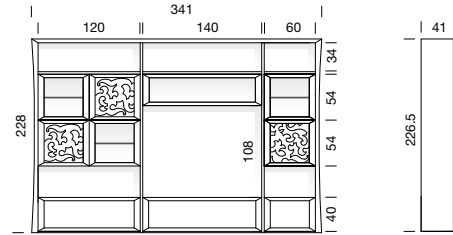
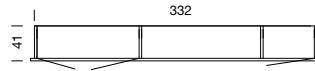

NOCE
FRASSINO

PFP0260K

PREZZO TOTALE COMPOSIZIONE
TOTAL PRICE FOR COMPOSITION

10.760

- 1 MODULO L 120 CON CESTONE, 2 ANTE VETRO E 2 TRAFORATE
MODULE W 120 WITH BASKET, 2 GLASS DOORS AND 2 PERFORATED DOORS
- 1 MODULO L 140 CON CESTONE E ANTA VASISTAS VETRO
MODULE W 140 WITH BASKET AND GLASS LIFT-UP DOOR
- 1 MODULO L 60 CON CESTONE, ANTA VETRO E ANTA TRAFORATA
MODULE W 60 WITH BASKET, GLASS DOOR AND PERFORATED DOOR
- 2 DIVISIONE A TERRA H 226,5
FLOOR-STANDING PARTITION H 226,5
- 2 FIANCO A TERRA H 226,5
FLOOR-STANDING SIDE PANEL H 226,5
- 1 CORNICE PERIMETRALE H 228
PERIMETRIC FRAME H 228

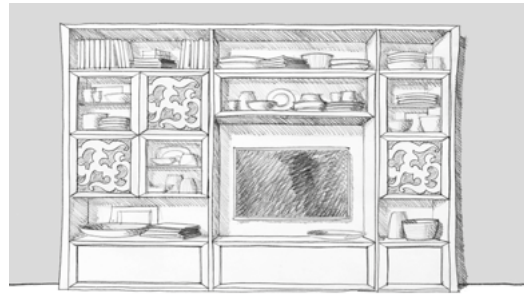

L. W. 341
H. H. 228
P. D. 41

COMPOSIZIONE 262 COMPOSITION 262

PAG. 118 CATALOGO "PROPOSTE ARREDATIVE"
PAGE 118 "FURNISHING SOLUTIONS" CATALOGUE

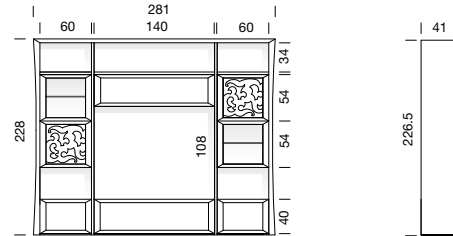
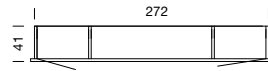

NOCE
FRASSINO

PFP0262K

PREZZO TOTALE COMPOSIZIONE
TOTAL PRICE FOR COMPOSITION

9.287

- 2 MODULO L 60 CON CESTONE, ANTA VETRO E ANTA TRAFORATA
MODULE W 60 WITH BASKET, GLASS DOOR AND PERFORATED DOOR
- 1 MODULO L 140 CON CESTONE E ANTA VASISTAS LEGNO
MODULE W 140 WITH BASKET AND WOODEN LIFT-UP DOOR
- 2 DIVISIONE A TERRA H 226,5
FLOOR-STANDING PARTITION H 226,5
- 2 FIANCO A TERRA H 226,5
FLOOR-STANDING SIDE PANEL H 226,5
- 1 CORNICE PERIMETRALE H 228
PERIMETRIC FRAME H 228

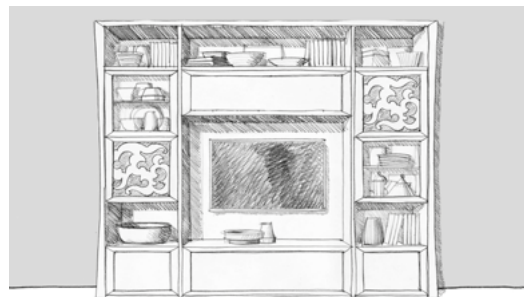

L. W. 281
H. H. 228
P. D. 41

COMPOSIZIONE 264 COMPOSITION 264

PAG. 119 CATALOGO "PROPOSTE ARREDATIVE"
PAGE 119 "FURNISHING SOLUTIONS" CATALOGUE

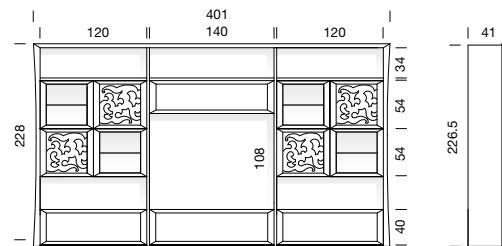
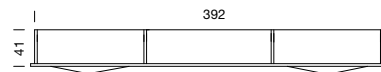

NOCE
FRASSINO

PFP0264K

PREZZO TOTALE COMPOSIZIONE
TOTAL PRICE FOR COMPOSITION

12.268

- 2 MODULO L 120 CON CESTONE, 2 ANTE VETRO E 2 TRAFORATE
MODULE W 120 WITH BASKET, 2 GLASS DOORS AND 2 PERFORATED DOORS
- 1 MODULO L 140 CON CESTONE E ANTA VASISTAS VETRO
MODULE W 140 WITH BASKET AND GLASS LIFT-UP DOOR
- 2 DIVISIONE A TERRA H 226,5
FLOOR-STANDING PARTITION H 226,5
- 2 FIANCO A TERRA H 226,5
FLOOR-STANDING SIDE PANEL H 226,5
- 1 CORNICE PERIMETRALE H 228
PERIMETRIC FRAME H 228



L. W. 401
H. H. 228
P. D. 41

PORTOFINO SISTEMA PARETE - WALL SYSTEM

COMPOSIZIONI A CATALOGO

CATALOGUE COMPOSITIONS

POSSIBILITÀ DI FRONTALE DIVERSO DALLA SCOCCA, SPECIFICARE LA FINITURA SCELTA

IN CASE OF FRONT DIFFERENT FROM THE CARCASE, CONSIDER THE HIGHER PRICE OF THE CHOSEN FINISH

COMPOSIZIONE 268

COMPOSITION 268

PAG. 121 CATALOGO "PROPOSTE ARREDATIVE"
PAGE 121 "FURNISHING SOLUTIONS" CATALOGUE

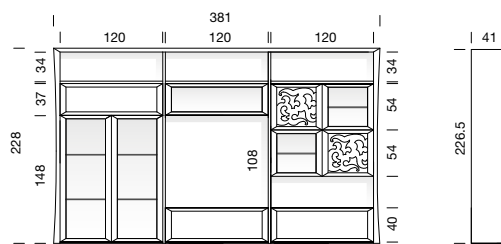
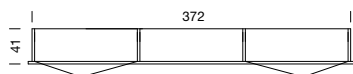

NOCE
FRASSINO

PFP0268K

PREZZO TOTALE COMPOSIZIONE
TOTAL PRICE FOR COMPOSITION

10.681

- 1 MODULO L 120 CON 2 ANTE VETRO, VASISTAS LEGNO E VANO A GIORNO
MODULE W 120 WITH 2 GLASS DOORS, WOODEN LIFT-UP DOOR AND OPEN COMPARTMENT
- 1 MODULO L 120 CON CESTONE E ANTA VASISTAS VETRO
MODULE W 120 WITH BASKET AND GLASS LIFT-UP DOOR
- 1 MODULO L 120 CON CESTONE, 2 ANTE VETRO E 2 TRAFORATE
MODULE W 120 WITH BASKET, 2 GLASS DOORS 4 AND 2 PERFORATED DOORS
- 2 DIVISIONE A TERRA H 226.5
FLOOR-STANDING PARTITION H 226.5
- 2 FIANCO A TERRA H 226.5
FLOOR-STANDING SIDE PANEL H 226.5
- 1 CORNICE PERIMETRALE H 228
PERIMETRIC FRAME H 228



L. W. 381
H. H. 228
P. D. 41

COMPOSIZIONE 201

COMPOSITION 201

PAG. 122 CATALOGO "PROPOSTE ARREDATIVE"
PAGE 122 "FURNISHING SOLUTIONS" CATALOGUE

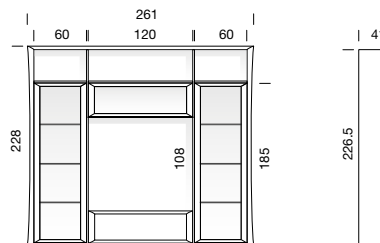
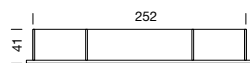

NOCE
FRASSINO

PFP0201K

PREZZO TOTALE COMPOSIZIONE
TOTAL PRICE FOR COMPOSITION

6.931

- 2 MODULO L 60 CON ANTA VETRO E VANO A GIORNO
MODULE W 60 WITH GLASS DOOR AND OPEN COMPARTMENT
- 1 MODULO L 120 CON ANTA VETRO VASISTAS VETRO E 1 CESTONE
MODULE W 120 WITH GLASS DOOR, GLASS LIFT-UP DOOR AND BASKET
- 2 FIANCO A TERRA H 226.5
FLOOR-STANDING SIDE PANEL H 226.5
- 2 DIVISIONE A TERRA H 226.5
FLOOR-STANDING PARTITION H 226.5
- 1 CORNICE PERIMETRALE H 228
PERIMETRIC FRAME H 228

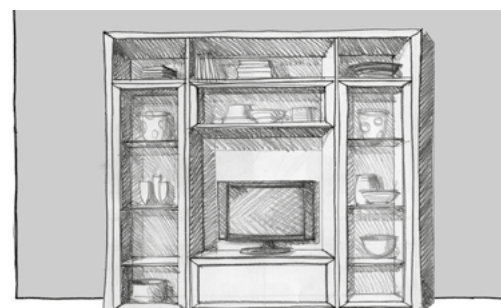

L. W. 261
H. H. 228
P. D. 41

COMPOSIZIONE 208

COMPOSITION 208

PAG. 125 CATALOGO "PROPOSTE ARREDATIVE"
PAGE 125 "FURNISHING SOLUTIONS" CATALOGUE

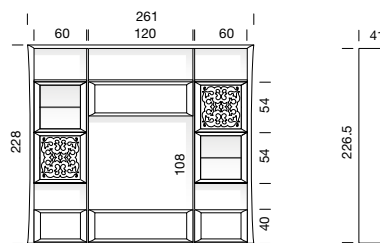
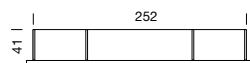

NOCE
FRASSINO

PFP0208K

PREZZO TOTALE COMPOSIZIONE
TOTAL PRICE FOR COMPOSITION

8.674

- 2 MODULI L 60 CON CESTONE, ANTA TRAFORATA E ANTA VETRO
MODULES W 60 WITH BASKET, PERFORATED DOOR AND GLASS DOOR
- 1 MODULO L 120 CON CESTONE E ANTA VASISTAS LEGNO
MODULE W 120 WITH BASKET AND LIFT-UP WOODEN DOOR
- 2 FIANCO A TERRA H 226.5
FLOOR-STANDING SIDE PANEL H 226.5
- 2 DIVISIONE A TERRA H 226.5
FLOOR-STANDING PARTITION H 226.5
- 1 CORNICE PERIMETRALE H 228
PERIMETRIC FRAME H 228

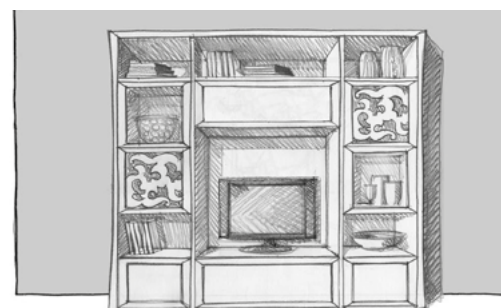

L. W. 261
H. H. 228
P. D. 41

COMPOSIZIONI A CATALOGO CATALOGUE COMPOSITIONS

POSSIBILITÀ DI FRONTALE DIVERSO DALLA SCOCCA, SPECIFICARE LA FINITURA SCELTA
IN CASE OF FRONT DIFFERENT FROM THE CARCASE CONSIDER THE HIGHER PRICE OF THE CHOOSEN FINISH

COMPOSIZIONE 212 COMPOSITION 212

PAG. 126 CATALOGO "PROPOSTE ARREDATIVE"
PAGE 126 "FURNISHING SOLUTIONS" CATALOGUE

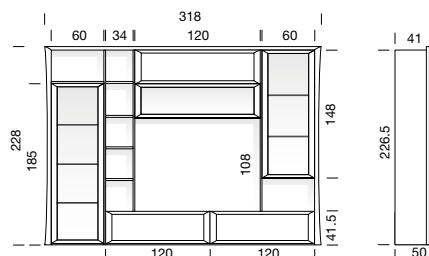
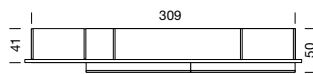

NOCE
FRASSINO

PFP0212K

PREZZO TOTALE COMPOSIZIONE
TOTAL PRICE FOR COMPOSITION

9.834

- 1 MODULO L 60 CON ANTA VETRO
MODULE W 60 WITH GLASS DOOR
- 1 MODULO HOME THEATRE L 240 CON 2 CESTONI, LIBRERIA, VANO TV CON ANTA VASISTAS LEGNO E ANTA RIBALTA VETRO E VANO CON ANTA VETRO
HOME THEATRE MODULE W 240 WITH 2 BASKETS, BOOKCASE, TV COMP. W 140 WITH LIFT-UP WOODEN DOOR AND GLASS DROP-DOWN DOOR AND COMP. W 60 WITH GLASS DOOR
- 2 FIANCO A TERRA H 226,5
FLOOR-STANDING SIDE PANEL H 226,5
- 1 DIVISIONE A TERRA H 226,5
FLOOR-STANDING PARTITION H 226,5
- 1 CORNICE PERIMETRALE H 228
PERIMETRIC FRAME H 228

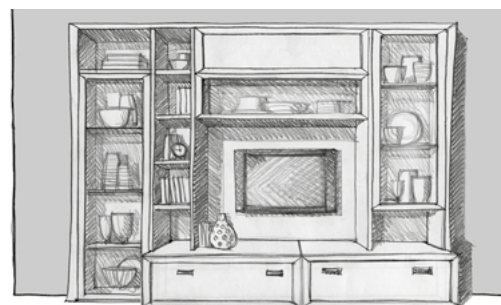

L. W. 318
H. H. 228
P. D. 41/50

COMPOSIZIONE 214 COMPOSITION 214

PAG. 127 CATALOGO "PROPOSTE ARREDATIVE"
PAGE 127 "FURNISHING SOLUTIONS" CATALOGUE

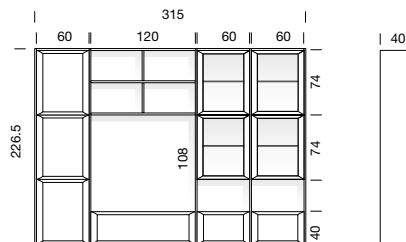
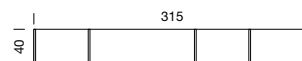

NOCE
FRASSINO

PFP0214K

PREZZO TOTALE COMPOSIZIONE
TOTAL PRICE FOR COMPOSITION

10.075

- 1 MODULO L 60 CON 3 ANTE LEGNO
MODULE W 60 WITH 3 WOODEN DOORS
- 1 MODULO L 120 CON CESTONE E VANI A GIORNO
MODULE W 120 WITH BASKET AND OPEN COMPART.
- 2 MODULO L 60 CON CESTONE E 2 ANTE VETRO
MODULE W 60 WITH BASKET AND 2 GLASS DOORS
- 2 FIANCO A TERRA H 226,5
FLOOR-STANDING SIDE PANEL H 226,5
- 3 DIVISIONE A TERRA H 226,5
FLOOR-STANDING PARTITION H 226,5

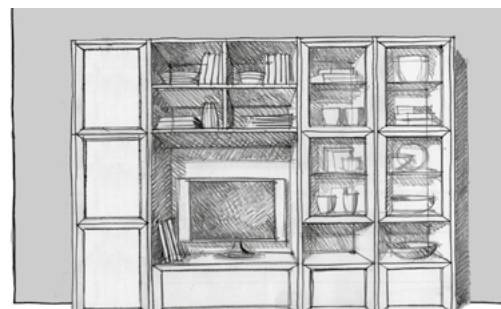

L. W. 315
H. H. 226,5
P. D. 40

COMPOSIZIONE 215 COMPOSITION 215

PAG. 128 CATALOGO "PROPOSTE ARREDATIVE"
PAGE 128 "FURNISHING SOLUTIONS" CATALOGUE

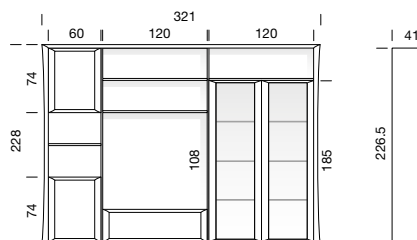
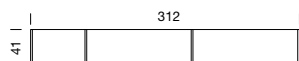

NOCE
FRASSINO

PFP0215K

PREZZO TOTALE COMPOSIZIONE
TOTAL PRICE FOR COMPOSITION

7.947

- 1 MODULO L 60 CON 2 ANTE LEGNO
MODULE W 60 WITH 2 WOODEN DOORS
- 1 MODULO L 120 CON CESTONE E VANI A GIORNO
MODULE W 120 WITH BASKET AND OPEN COMPART.
- 2 MODULO L 120 CON 2 ANTE VETRO E VANO A GIORNO
MODULE W 120 WITH 2 GLASS DOORS AND OPEN COMPART.
- 2 FIANCO A TERRA H 226,5
FLOOR-STANDING SIDE PANEL H 226,5
- 2 DIVISIONE A TERRA H 226,5
FLOOR-STANDING PARTITION H 226,5

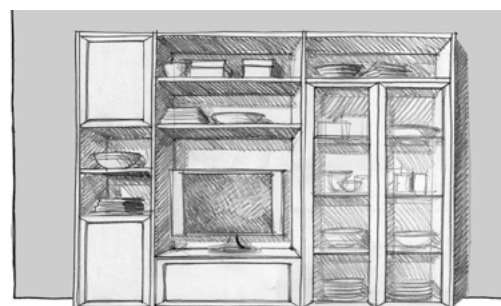

L. W. 321
H. H. 226,5
P. D. 41

PORTOFINO SISTEMA PARETE - WALL SYSTEM

COMPOSIZIONI A CATALOGO

CATALOGUE COMPOSITIONS

POSSIBILITÀ DI FRONTALE DIVERSO DALLA SCOCCA, SPECIFICARE LA FINITURA SCELTA

IN CASE OF FRONT DIFFERENT FROM THE CARCASE CONSIDER THE HIGHER PRICE OF THE CHOSEN FINISH

COMPOSIZIONE 217

COMPOSITION 217

PAG. 85 CATALOGO "MODOZINE",
PAG. 114-115 CATALOGO "PORTOFINO NEW" E
PAG. 129 CATALOGO "PROPOSTE ARREDATIVE"
PAGE 85 "MODOZINE",
PAGE 114-115 "PORTOFINO NEW" AND
PAGE 129 "FURNISHING SOLUTIONS" CATALOGUE

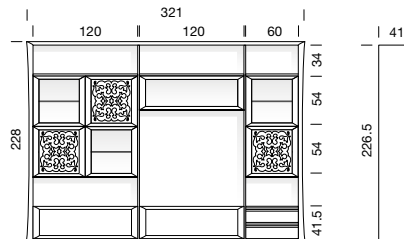
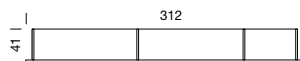

NOCE
FRASSINO

PFP0217K

PREZZO TOTALE COMPOSIZIONE
TOTAL PRICE FOR COMPOSITION

10.224

- 1 MODULO L 120 CON CESTONE, 2 ANTE TRAFORATE E 2 ANTE VETRO
MODULE W 120 WITH BASKET, 2 PERFORATED DOORS AND 2 GLASS DOORS
- 1 MODULO L 120 CON CESTONE E ANTA VETRO VASISTAS
MODULE W 120 WITH BASKET AND GLASS LIFT-UP DOOR
- 1 MODULO L 60 CON 2 CASSETTI, ANTA VETRO E ANTA TRAFORATA
MODULE W 60 WITH 2 DRAWERS, GLASS DOOR AND PERFORATED DOOR
- 2 FIANCO A TERRA H 226,5
FLOOR-STANDING SIDE PANEL H 226,5
- 2 DIVISIONE A TERRA H 226,5
FLOOR-STANDING PARTITION H 226,5
- 1 CORNICE PERIMETRALE H 228
PERIMETRIC FRAME H 228



L. W. 321
H. H. 228
P. D. 41

COMPOSIZIONE 218

COMPOSITION 218

PAG. 130 CATALOGO "PROPOSTE ARREDATIVE"
PAGE 130 "FURNISHING SOLUTIONS" CATALOGUE

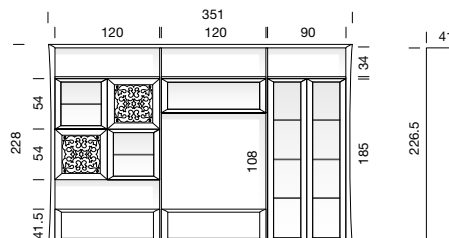
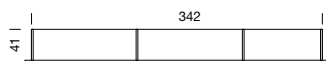

NOCE
FRASSINO

PFP0218K

PREZZO TOTALE COMPOSIZIONE
TOTAL PRICE FOR COMPOSITION

9.966

- 1 MODULO L 120 CON CESTONE, 2 ANTE TRAFORATE E 2 ANTE VETRO
MODULE W 120 WITH BASKET, 2 PERFORATED DOORS AND 2 GLASS DOORS
- 1 MODULO L 120 CON CESTONE E ANTA VETRO VASISTAS
MODULE W 120 WITH BASKET AND GLASS LIFT-UP DOOR
- 1 MODULO L 90 CON 2 ANTE VETRO
MODULE W 90 WITH 2 GLASS DOORS
- 2 FIANCO A TERRA H 226,5
FLOOR-STANDING SIDE PANEL H 226,5
- 2 DIVISIONE A TERRA H 226,5
FLOOR-STANDING PARTITION H 226,5
- 1 CORNICE PERIMETRALE H 228
PERIMETRIC FRAME H 228



L. W. 351
H. H. 228
P. D. 41

COMPOSIZIONE 222

COMPOSITION 222

PAG. 132 CATALOGO "PROPOSTE ARREDATIVE"
PAGE 132 "FURNISHING SOLUTIONS" CATALOGUE

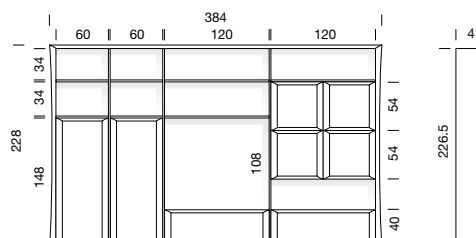
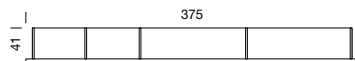

NOCE
FRASSINO

PFP0222K

PREZZO TOTALE COMPOSIZIONE
TOTAL PRICE FOR COMPOSITION

10.392

- 2 MODULI L 60 CON ANTA LEGNO E VANI A GIORNO
MODULES W 60 WITH WOODEN DOOR H 148 AND OPEN COMPART.
- 1 MODULO L 120 CON CESTONE E VANI A GIORNO
MODULE W 120 WITH BASKET AND OPEN COMPART.
- 1 MODULO L 120 CON 1 CESTONE E 4 ANTE LEGNO
MODULE W 120 WITH BASKET AND 4 WOODEN DOORS
- 2 FIANCO A TERRA H 226,5
FLOOR-STANDING SIDE PANEL H 226,5
- 3 DIVISIONE A TERRA H 226,5
FLOOR-STANDING PARTITION H 226,5
- 1 CORNICE PERIMETRALE H 228
PERIMETRIC FRAME H 228

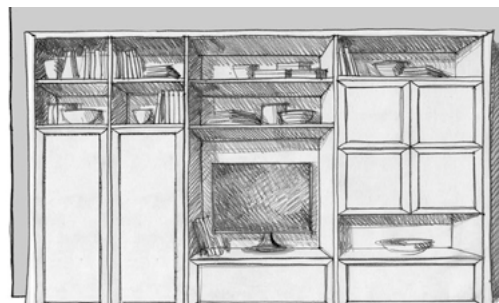

L. W. 384
H. H. 228
P. D. 41

COMPOSIZIONI A CATALOGO CATALOGUE COMPOSITIONS

POSSIBILITÀ DI FRONTALE DIVERSO DALLA SCOCCA, SPECIFICARE LA FINITURA SCELTA
IN CASE OF FRONT DIFFERENT FROM THE CARCASE CONSIDER THE HIGHER PRICE OF THE CHOOSEN FINISH

COMPOSIZIONE 225

COMPOSITION 225

PAG. 133 CATALOGO "PROPOSTE ARREDATIVE"
PAGE 133 "FURNISHING SOLUTIONS" CATALOGUE

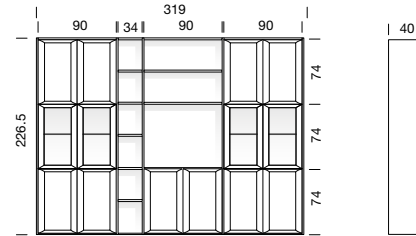
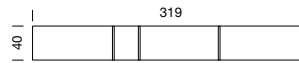

NOCE
FRASSINO

PFP0225K

PREZZO TOTALE COMPOSIZIONE
TOTAL PRICE FOR COMPOSITION

10.369

2	MODULO L 90 CON 4 ANTE LEGNO E 2 ANTE VETRO MODULE W 90 WITH 4 WOODEN DOORS AND 2 GLASS DOORS
1	MODULO A GIORNO L 34 OPEN MODULE W 34
1	MODULO L 90 CON 2 ANTE LEGNO E VANI A GIORNO MODULE W 90 WITH 2 WOODEN DOORS AND OPEN COMPART.
2	FIANCO A TERRA H 226.5 FLOOR-STANDING SIDE PANEL H 226.5
3	DIVISIONE A TERRA H 226.5 FLOOR-STANDING PARTITION H 226.5

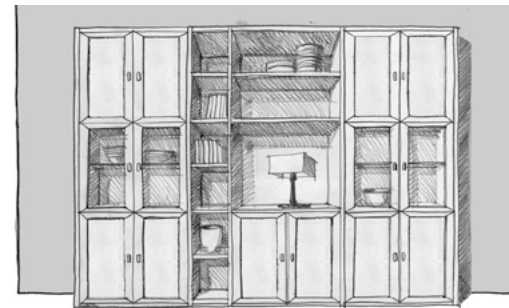

L. W. 319
H. H. 226.5
P. D. 40

COMPOSIZIONE 54

COMPOSITION 54

PAG. 112-113 CATALOGO "PORTOFINO NEW"
PAGE 112-113 NEW "PORTOFINO NEW" CATALOGUE

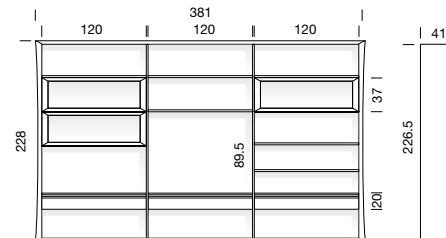
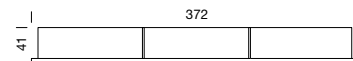

NOCE
FRASSINO

PFP0054K

PREZZO TOTALE COMPOSIZIONE
TOTAL PRICE FOR COMPOSITION

9.935

1	MODULO L 120 CON CASSETTO, ANTA RIBALTA VETRO E ANTA VASISTAS VETRO MODULE W 120 WITH DRAWER, GLASS DROP-DOWN DOOR AND GLASS LIFT-UP DOOR
1	MODULO L 120 CON CASSETTO E 2 RIPIANI MODULE W 120 WITH DRAWER AND 2 SHELVES
1	MODULO L 120 CON CASSETTO, 2 RIPIANI E ANTA VASISTAS VETRO MODULE W 120 WITH DRAWER, 2 SHELVES AND GLASS LIFT-UP DOOR
2	FIANCO A TERRA H 226.5 FLOOR-STANDING SIDE PANEL H 226.5
2	DIVISIONE A TERRA H 226.5 FLOOR-STANDING PARTITION H 226.5
1	CORNICE PERIMETRALE H 228 PERIMETRIC FRAME H 228



L. W. 381
H. H. 228
P. D. 41

COMPOSIZIONE 55

COMPOSITION 55

PAG. 118-119 CATALOGO "PORTOFINO NEW"
PAGE 118-119 NEW "PORTOFINO NEW" CATALOGUE

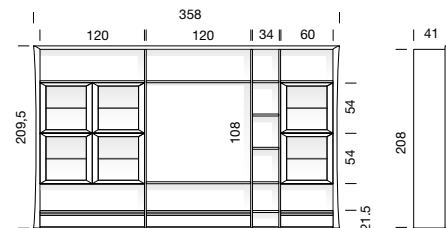
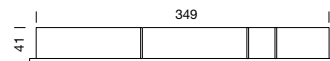

NOCE
FRASSINO

PFP0055K

PREZZO TOTALE COMPOSIZIONE
TOTAL PRICE FOR COMPOSITION

10.111

1	MODULO L 60 CON 1 CASSETTO E 2 ANTE VETRO MODULE W 60 WITH DRAWER AND 2 GLASS DOORS
1	MODULO A GIORNO L 34 OPEN MODULE W 34
1	MODULO L 120 CON CASSETTO E 2 RIPIANI MODULE W 120 WITH DRAWER AND 2 SHELVES
1	MODULO L 120 CON 1 CASSETTO E 4 ANTE VETRO MODULE W 120 WITH DRAWER AND 4 GLASS DOORS
2	FIANCO A TERRA H 208 FLOOR-STANDING SIDE PANEL H 208
3	DIVISIONE A TERRA H 208 FLOOR-STANDING PARTITION H 208
1	CORNICE PERIMETRALE H 209.5 PERIMETRIC FRAME H 209.5



L. W. 345
H. H. 209,5
P. D. 40

PORTOFINO SISTEMA PARETE - WALL SYSTEM

COMPOSIZIONI A CATALOGO

CATALOGUE COMPOSITIONS

POSSIBILITÀ DI FRONTALE DIVERSO DALLA SCOCCA, SPECIFICARE LA FINITURA SCELTA

IN CASE OF FRONT DIFFERENT FROM THE CARCASE, CONSIDER THE HIGHER PRICE OF THE CHOOSEN FINISH

COMPOSIZIONE 58

COMPOSITION 58

PAG. 122-123 CATALOGO "PORTOFINO NEW"
PAGE 122-123 NEW "PORTOFINO NEW" CATALOGUE

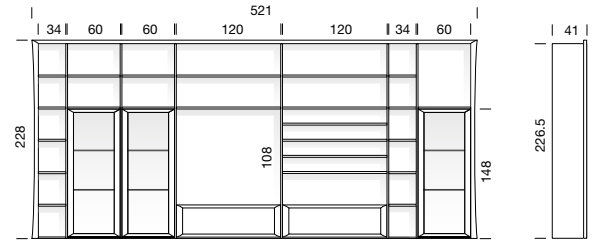
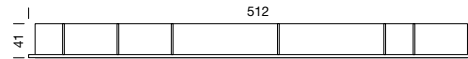

NOCE
FRASSINO

PFP0058K

PREZZO TOTALE COMPOSIZIONE
TOTAL PRICE FOR COMPOSITION

14.564

2	MODULO A GIORNO L 34 OPEN MODULE W 34
3	MODULO L 60 CON RIPIANO E ANTA VETRO MODULE W 60 WITH SHELF AND GLASS DOOR
1	MODULO L 120 CON CESTONE E 2 RIPIANI MODULE W 120 WITH BASKET AND 2 SHELVES
1	MODULO L 120 CON CESTONE E 6 RIPIANI MODULE W 120 WITH BASKET AND 6 SHELVES
2	FIANCO A TERRA H 226.5 FLOOR-STANDING SIDE PANEL H 226.5
6	DIVISIONE A TERRA H 226.5 FLOOR-STANDING PARTITION H 226.5
1	CORNICE PERIMETRALE H 228 PERIMETRIC FRAME H 228



L. W. 504
H. H. 228
P. D. 41



PREZZI DA APPLICARE PER PRODOTTI FUORI STANDARD O "SU MISURA"

COSA SI DEVE INTENDERE PER FUORI STANDARD:

SI INTENDONO TUTTI I PRODOTTI A LISTINO CON DIMENSIONI INFERIORI RISPETTO A QUANTO ESPOSTO NEL MEDESIMO.

PER TALI PRODOTTI DOVRANNO ESSERE APPLICATE LE SEGUENTI MAGGIORAZIONI:

- + 30 %** RISPETTO AL PREZZO DI LISTINO PER UN SOLO TAGLIO (ES: LARGHEZZA, PROFONDITÀ O ALTEZZA)
- + 40 %** RISPETTO AL PREZZO DI LISTINO SE LE RIDUZIONI SONO DI 2 O 3 TAGLI (ES: LARGHEZZA E PROFONDITÀ O LARGHEZZA E ALTEZZA ECC)

PER RICHIESTE DI PRODOTTI CON DIMENSIONI SUPERIORI RISPETTO A QUELLE STANDARD DEL LISTINO DEVE ESSERE RICHIESTO IL PREVENTIVO ALL'AZIENDA, IN QUANTO COMPORTA MOLTE VARIABILI.

PER MODIFICHE RELATIVE ALLA LUCIDATURA DOVRANNO ESSERE CONSIDERATE LE SEGUENTI MAGGIORAZIONI:

- + 10 %** PER LACCATO OPACO COPRENTE COLORI DA CAMPIONARIO MODO10
- + 10 %** PER FINITURA VERNICIATA A CAMPIONE

GLI ORDINI CON MISURE SPECIALI, ACCETTATI DALL'AZIENDA, SI DEVONO RITENERE IRREVOCABILI.

SI RICHIEDE INOLTRE PER GLI STESSI UN PAGAMENTO ANTICIPATO ALL'ORDINE PARI AL 30% DELL'IMPORTO DOVUTO.

PER CONSEGNE DI IMPORTI INFERIORI A 600 EURO NETTI A MEZZO BIANCHINI SRL, È PREVISTO UN CONTRIBUTO SPESE DI TRASPORTO PARI A 60 EURO.

PER CONSEGNE DI IMPORTI INFERIORI A 600 EURO NETTI A MEZZO CORRIERE ESPRESSO, VERRÀ CALCOLATO IL PREZZO DEL CORRIERE

PER IMBALLO IN CASSE DI LEGNO CALCOLARE UNA MAGGIORAZIONE SUL PREZZO DI LISTINO DI +15%

PRICES FOR OUT OF STANDARD OR "MADE-TO-MEASURE" PRODUCTS

WHAT DO YOU MEAN FOR OUT OF STANDARD:

THIS REFERS TO ALL PRODUCTS IN THE PRICE LIST WITH SMALLER DIMENSIONS THAT THOSE GIVEN.

FOR THESE PRODUCTS THE FOLLOWING SURCHARGES ARE APPLICABLE:

- + 30 %** ON THE LIST PRICE FOR A SINGLE CUTTING OPERATION (E.G. WIDTH, DEPTH OR HEIGHT).
- + 40 %** ON THE LIST PRICE IF THERE ARE 2 OR 3 CUTTING OPERATIONS (E.G. WIDTH AND DEPTH OR WIDTH AND HEIGHT, ETC.)

FOR PRODUCTS BIGGER THAN STANDARD IN THE PRICE LIST, PLEASE APPLY TO THE COMPANY FOR AN ESTIMATE, AS MANY VARIABLES ARE INVOLVED.

FOR POLISHING MODIFICATIONS CONSIDER THE FOLLOWING SURCHARGES:

- + 10 %** FOR ONE-COAT PAINTED FINISH IN MATT MODO10 SAMPLER
- + 10 %** FOR SAMPLE PAINTED FINISH

WHEN ORDERS FOR SPECIAL MEASUREMENTS ARE ACCEPTED BY THE COMPANY, THEY ARE IRREVOCABLE.

WHEN SUCH ORDERS ARE PLACED AN ADVANCE PAYMENT OF 30% OF THE AMOUNT DUE IS REQUIRED.

FOR DELIVERIES AMOUNTING TO LESS THAN 600 EURO (NET PRICE), A 60 EURO CONTRIBUTION TO THE TRANSPORT COSTS IS FORESEEN.

FOR DELIVERIES OF AMOUNTS LESS THAN 600 EUROS NET BY EXPRESS COURIER, THE COURIER PRICE WILL BE CALCULATED

FOR PACKAGING IN WOODEN CRATES CALCULATE AN INCREASE ON THE LIST PRICE OF + 15%

CONDIZIONI GENERALI DI VENDITA

VALIDITÀ: IL PRESENTE LISTINO ANNULLA E SOSTITUISCE TUTTI I PRECEDENTI.

LA BIANCHINI S.R.L. SI RISERVA IL DIRITTO DI APPORTARVI IN QUALUNQUE MOMENTO E SENZA PREAVVISO TUTTE LE MODIFICHE CHE SI RENDONO OPPORTUNE, DECLINANDO OGNI RESPONSABILITÀ PER EVENTUALI INESATTEZZE IN ESSO CONTENUTE, SE DERIVANTI DA ERRORI DI STAMPA O TRASCRIZIONE.

I PREZZI, ESPRESSI IN EURO SI INTENDONO AL PUBBLICO ESCLUSA IVA.

LE MISURE SONO ESPRESSE IN CM.

I DISEGNI DELLE SCHEDE TECNICHE E DEL LISTINO VENDITA E LE FOTO DELLE COMPOSIZIONI SONO INDICATIVE E NON RAPPRESENTANO L'EFFETTIVA ESTETICA DEL PRODOTTO. LA BIANCHINI S.R.L. SI RISERVA DI MODIFICARE, PER NECESSITÀ TECNICHE O MIGLIORAMENTI, I PRODOTTI SENZA PREAVVISO. NON SARÀ ACCETTATA ALCUNA CONTESTAZIONE PER L'INTERPRETAZIONE DI DISEGNI O PER LE MODIFICHE APPORTATE AD OGNI SINGOLO ELEMENTO.

OGGETTO: L'OGGETTO DELLA FORNITURA E IL PREZZO DELLA STESSA VENGONO ESPRESSAMENTE INDICATI DALLA PRESENTE SCRITTURA. TUTTO QUANTO NON SPECIFICAMENTE INDICATO S'INTENDE ESCLUSO. LA MODIFICA ANCHE DI UNA SOLA VOCE, SALVO PATTO CONTRARIO, FA DECADERE DA OGNI IMPEGNATIVA DI PREZZO ED OGNI VARIAZIONE O AGGIUNTA RISPETTO A QUANTO NOMINATO, SARÀ IN OGNI CASO A CARICO DEL CLIENTE.

ORDINI: GLI ORDINI SONO ACCETTATI SALVO APPROVAZIONE DELL'AZIENDA. LA BIANCHINI S.R.L. AD ORDINE ACCETTATO INVIERÀ UNA CONFERMA D'ORDINE AL CLIENTE. TRASCORSI 5 GIORNI DAL RICEVIMENTO DI QUEST'ULTIMA, L'ORDINE SI RITERRÀ VALIDO IN TUTTE LE SUE PARTI, PERTANTO NON SARANNO PIÙ ACCETTATI ANNULLAMENTI O MODIFICHE.

CONSEGNA: I TERMINI DI CONSEGNA ASSUMONO PER L'AZIENDA VALORE PURAMENTE INDICATIVO E NON VINCOLANTE.

PRODOTTO: I DATI TECNICI RELATIVI AI PRODOTTI RIPORTATI NEL PRESENTE LISTINO SONO PURAMENTE INDICATIVI. LA BIANCHINI S.R.L. SI RISERVA LA FACOLTÀ DI APPORTARE TUTTE LE MODIFICHE CHE RITERRÀ OPPORTUNE E NECESSARIE.

BOX CAMPIONARI: NON DEVE INTENDERSI IN SENSO TASSATIVO, IN QUANTO SUSSISTONO MARGINI DI TOLLERANZA DOVUTI A VARIAZIONI DEL PRODOTTO (COLORI, MATERIALI, MISURE, ECC.) OPPURE PRINCIPALMENTE DA FATTORI AMBIENTALI (UMIDITÀ, LUCE, ECC.).

CARATTERISTICHE DEL PRODOTTO: IL PRINCIPALE COMPONENTE UTILIZZATO NELLA COSTRUZIONE DEGLI ARREDI È IL LEGNO. IL LEGNO ESSENDO UN PRODOTTO NATURALE PUÒ CONTENERE DELLE DIFFORMITÀ DI VENATURA E DI TONALITÀ CHE SONO GARANZIA PROPRIA DEL MATERIALE STESSO E QUINDI NON DEVONO ESSERE INTESI COME DIFETTOSITÀ.

LA BIANCHINI S.R.L. NON GARANTISCE L' UNIFORMITÀ DELLA VENATURA DEL LEGNO E/O DEL COLORE PER MOBILI DI COLLEZIONI DIFFERENTI CHE VENGONO ABBINATI E NON SI ASSUME LA RESPONSABILITÀ DELLE DIFFERENZE CROMATICHE POSSIBILI IN CASO DI ORDINI PER COMPLETAMENTO O SOSTITUZIONE.

CONSISTENZA DELLE PARETI MURARIE: LA TENUTA DEI DISPOSITIVI DI FISSAGGIO È SUBORDINATA ALLA CONSISTENZA DELLE PARETI MURARIE/SOFFITTI/PAVIMENTI A CUI GLI STESSI SONO APPLICATI.

INSTALLAZIONE: È IMPORTANTE CHE VENGA ESEGUITA DA PERSONE REALMENTE COMPETENTI; SI DECLINA OGNI RESPONSABILITÀ PER ERRATI MONTAGGI DA PARTE DEL RIVENDITORE O DI TERZI E PER GLI EVENTUALI DANNI CONSEGUENTI.

NESSUN DANNO DIRETTO O INDIRETTO PUÒ ESSERE RICHIESTO PER MANCATA O RITARDATA CONSEGNA.

TRASPORTO: LA MERCE SE VENDUTA FRANCO FABBRICA VIAGGIA A RISCHIO E PERICOLO DEL CLIENTE MENTRE, SE VENDUTA FRANCO DESTINO, VIAGGIA A RISCHIO E PERICOLO DELL'AZIENDA FIN DOVE ARRIVANO GLI AUTOMEZZI SU SPONDA CAMION. VERRANNO ADDEBITATI GLI EVENTUALI COSTI DI FACCHINAGGIO PER IL POSIZIONAMENTO DELLA MERCE NEL MAGAZZINO DEL CLIENTE.

RECLAMI: I RECLAMI SONO AMMESSI SOLO SE FATTI ENTRO OTTO GIORNI DALLA DATA DI CONSEGNA. TRASCORSO TALE PERIODO L'AZIENDA DECLINA OGNI RESPONSABILITÀ. PER EVENTUALI DANNI CAUSATI ALLA MERCE DURANTE IL TRASPORTO, O COLLI MANCANTI, I RECLAMI DOVRANNO ESSERE MANIFESTATI AL VETTORE AL RICEVIMENTO DELLA MERCE. IL DOCUMENTO DI TRASPORTO FIRMATO AL MOMENTO DELLO SCARICO VALE COME DICHIARAZIONE DI ESATTA CORRISPONDENZA DI QUANTO IN ESSO CONTENUTO.

PAGAMENTI: PER NESSUN MOTIVO ED A NESSUN TITOLO IL CLIENTE PUÒ DIFFERIRE O SOSPENDERE I PAGAMENTI OLTRE LE SCADENZE PATTUITE IN FATTURA; IL MANCATO O RITARDATO PAGAMENTO ANCHE DI UNA SOLA RATA COMPORTERÀ LA DECADENZA DAL BENEFICIO DI TUTTI I TERMINI PATTUITI, RENDENDO IMMEDIATAMENTE ESIGIBILE L'INTERO CREDITO CON L'ADDEBITO DEGLI INTERESSI DI MORA PREVISTI PER LEGGE. IN QUALSIASI FORMA SIA CONVENUTO IL PAGAMENTO, SONO A CARICO DEL CLIENTE TUTTE LE SPESE PER GLI ONERI RELATIVI, COSÌ COME I RISCHI PER FURTI E/O SMARRIMENTI DEI TITOLI DURANTE LA CIRCOLAZIONE POSTALE E/O BANCARIA. GLI EFFETTI SONO DA NOI ACCETTATI SALVO BUON FINE E NON COSTITUISCONO NOVAZIONE DI CREDITO.

RESI: NON SI ACCETTANO RESI DI MERCE SE NON AUTORIZZATI DALL'AZIENDA. I RESI ACCETTATI DALL'AZIENDA DEVONO ESSERE INTEGRI, IMBALLATI E ACCOMPAGNATI DA REGOLARE DOCUMENTO DI TRASPORTO. IL TRASPORTO È A CARICO DEL CLIENTE. I PRODOTTI RESI VENGONO ACCREDITATI ALLO STESSO PREZZO PAGATO IN FATTURA AL MOMENTO DELL'ACQUISTO, ADDEBITANDO LE EVENTUALI PARTI DANNEGGIATE O DIFETTATE. SI PRECISA CHE NON VERRANNO ACCETTATI RESI DI ELEMENTI REALIZZATI SU MISURA.

LEGGE APPLICABILE E FORO COMPETENTE: LE VENDITE SOTTOPOSTE ALLE PRESENTI CONDIZIONI GENERALI SONO REGOLATE DAL DIRITTO ITALIANO, E, OVE APPLICABILE, DALLA CONVENZIONE DI VIENNA DELL'11 APRILE 1980, SULLA VENDITA INTERNAZIONALE. OGNI CONTROVERSIA TRA LE PARTI IN RELAZIONE ALLE VENDITE SARÀ DI COMPETENZA DEL FORO DI VERONA (ITALIA).

GENERAL CONDITIONS OF SALE

VALIDITY: THIS PRICE LIST REPEALS AND REPLACES ALL PREVIOUS ONES.

BIANCHINI S.R.L. RESERVES THE RIGHT TO MAKE ANY NECESSARY CHANGE AT ANY TIME AND WITHOUT PRIOR NOTICE AND DOES NOT TAKE ANY RESPONSIBILITY FOR ANY INACCURACY WHEN CAUSED BY TYPING OR TRANSCRIPTION ERRORS

PRICES, EXPRESSED IN EUROS ARE INTENDED TO THE PUBLIC EXCLUDED VAT.

DIMENSIONS ARE IN CM.

THE DRAWINGS IN THE TECHNICAL SHEETS AND THE PRICE LIST AS WELL AS THE PHOTOS OF THE COMPOSITIONS ARE INDICATIVE AND DO NOT REPRESENT THE ACTUAL LOOK OF THE PRODUCT. BIANCHINI S.R.L. RESERVES THE RIGHT TO MODIFY THE PRODUCTS, FOR TECHNICAL REASONS OR FOR IMPROVEMENT, WITHOUT PRIOR NOTICE. NO CLAIM SHALL BE ACCEPTED ON THE INTERPRETATION OF DRAWINGS OR ON THE CHANGES MADE TO EACH SINGLE ITEM.

OBJECT: THE GOODS TO BE DELIVERED AND THEIR PRICE ARE EXPRESSLY MENTIONED IN THIS DOCUMENT. ANYTHING THAT IS NOT SPECIFIED SHALL BE UNDERSTOOD AS NOT INCLUDED.

THE CHANGE OF EVEN ONE SINGLE ITEM, IF NOT AGREED OTHERWISE, SHALL MAKE VOID ANY PRICE AGREEMENT AND EACH SINGLE VARIATION OR ADDITION TO WHAT IS LISTED WILL BE IN ANY CASE CHARGED TO THE CUSTOMER.

ORDERS: ORDERS ARE ACCEPTED ONLY ON APPROVAL BY THE COMPANY. AFTER ACCEPTING THE ORDER, BIANCHINI S.R.L. WILL SEND A CONFIRMATION OF ORDER TO THE CUSTOMER. AFTER 5 DAYS FROM RECEPTION OF THE CONFIRMATION OF ORDER, THE ORDER WILL BE CONSIDERED VALID IN ALL ITS PARTS AND THEREFORE NON CANCELLATIONS OR CHANGES WILL BE ACCEPTED ANY LONGER.

DELIVERY: THE DELIVERY TERM IS MERELY INDICATIVE FOR THE COMPANY AND IS NOT BINDING.

PRODUCT: THE TECHNICAL DATA CONCERNING THE PRODUCTS AND PROVIDED IN THIS PRICE LIST ARE MERELY INDICATIVE. BIANCHINI S.R.L. RESERVES THE RIGHT TO MAKE ANY CHANGE IT WILL CONSIDER APPROPRIATE AND NECESSARY.

SAMPLES BOX: IT SHALL NOT BE UNDERSTOOD IN ABSOLUTE TERMS SINCE THERE ARE TOLERANCES LINKED TO SLIGHT DIFFERENCES IN THE PRODUCTS – COLOURS, MATERIALS, SIZE, ETC. – OR MAINLY DUE TO ENVIRONMENTAL FACTORS SUCH AS HUMIDITY, LIGHT, ETC.

PRODUCT CHARACTERISTICS: THE MAIN MATERIAL USED TO MAKE THE FURNITURE IS WOOD. WOOD IS A NATURAL PRODUCT AND THEREFORE CAN SHOW DIFFERENT GRAINS AND COLOUR SHADES THAT ARE A GUARANTEE OF THE MATERIAL AND MUST NOT BE CONSIDERED AS DEFECTS.

BIANCHINI S.R.L. DOES NOT GUARANTEE UNIFORM WOOD GRAIN AND/OR COLOUR FOR FURNITURE UNITS BELONGING TO DIFFERENT COLLECTIONS AND THAT ARE PUT IN THE SAME COMPOSITION. MOREOVER, IT DOES NOT TAKE ANY RESPONSIBILITY FOR DIFFERENCES IN COLOUR THAT CAN EMERGE IN CASE OF ORDERS MADE TO COMPLETE A COMPOSITION OR TO REPLAC AN ITEM.

COMPACTNESS OF WALLS: THE HOLD OF THE FASTENING DEVICES DEPENDS ON THE COMPACTNESS OF WALLS/CEILINGS/FLOORS TO WHICH THE DEVICES ARE APPLIED.

INSTALLATION: IT IS IMPORTANT THAT THE ASSEMBLY IS PERFORMED BY SKILLED PERSONNEL. NO LIABILITY IS TAKEN FOR WRONG ASSEMBLY BY THE DEALER OR THIRD PARTIES AND FOR ANY DAMAGE DERIVING FROM IT.

NO DIRECT OR INDIRECT DAMAGE CLAIM CAN BE RAISED FOR LATE OR NO DELIVERY.

TRASPORT: WHEN THE GOODS ARE DELIVERED EX WORKS, THE TRANSPORT RISKS ARE BORNE BY THE CUSTOMER. WHEN THE GOODS ARE DELIVERED FREE AT DESTINATION, THE TRANSPORT RISKS ARE BORNE BY THE COMPANY UP TO THE POINT WHERE THE TRUCK CAN REACH. ANY COSTS FOR UNLOADING AND POSITIONING THE GOODS IN THE CUSTOMER'S WAREHOUSE WILL BE CHARGED TO THE CUSTOMER.

COMPLAINTS: CLAIMS ARE POSSIBLE ONLY IF RAISED WITHIN EIGHT DAYS FROM THE DATE OF DELIVERY.

AFTER THE EXPIRATION OF THIS TERM, THE COMPANY SHALL NOT TAKE ANY LIABILITY.

IN CASE OF DAMAGE CAUSED TO THE GOODS DURING TRANSPORTATION OR FOR MISSING ITEMS, CLAIMS SHALL BE RAISED TO THE CARRIER WHEN RECEIVING THE GOODS. THE TRASNPOT DOCUMENT THAT SHALL BE SIGNED WHEN UNLOADING THE GOODS AND SHALL BE CONSIDERED AS A DECLARATION THAT THE GOODS EXACTLY CORRESPOND TO WHAT IS LISTED ON THE DOCUMENT.

PAYMENTS: FOR NO REASON THE CUSTOMER HAS THE RIGHT TO DELAY OR SUSPEND PAYMENTS BEYOND THE TERMS AGREED IN THE INVOICE.

THE DELAYED PAYMENT OR NON-PAYMENT OF EVEN ONE SINGLE INSTALMENT SHALL CAUSE THE LOSS OF ELIGIBILITY TO THE CONDITIONS AGREED AND THE ENTIRE AMOUNT SHALL BE IMMEDIATELY PAYABLE WITH THE ADDITION OF THE LATE PAYMENT INTERESTS ENVISAGED BY THE LAW.

IRRESPECTIVE OF THE TYPE OF PAYMENT AGREED, ALL COSTS AND RELATED BURDENS ARE BORNE BY THE CUSTOMER AS WELL AS THE RISK OF THEFT AND/OR LOSS OF THE TITLES WHEN IN THE POST AND/OR BANK CIRCUIT.

BANKER'S DRAFTS ARE ACCEPTED SUBJECT TO COLLECTION AND ARE NOT CONSIDERED AS A RENEWAL OF CREDIT.

RETURNS: THE GOODS CANNOT BE RETURNED WITHOUT COMPANY AUTHORISATION.

RETURNED GOODS AUTHORISED BY THE COMPANY SHALL BE UNDAMAGED, PACKED AND ACCOMPANIED BY THE TRANSPORT DOCUMENT ENVISAGED BY THE LAW.

THE TRANSPORT SHALL BE CHARGED TO THE CUSTOMER.

RETURNED GOODS ARE REIMBURSED AT THE SAME PRICE FEATURING IN THE SALE INVOICE.

THE COSTS RELATED TO ANY DAMAGED OR DEFECT PARTS SHALL BE CHARGED TO THE CUSTOMER. MADE-TO-MEASURE ITEMS CANNOT BE RETURNED.

APPLICABLE LAW AND COMPETENT JURISDICTION: THE SALES REGULATED BY THESE GENERAL CONDITIONS ARE GOVERNED BY THE ITALIAN LAW AND, WHERE APPLICABLE, BY THE VIENNA CONVENTION OF 11 APRIL 1980 ON INTERNATIONAL SALES. ANY DISPUTE BETWEEN THE PARTIES CONCERNING THE SALES WILL BE UNDER THE JURISDICTION OF THE COURT OF VERONA (ITALY).



MODO 10

VIA G. AMENDOLA, 25 37052 CASALEONE (VR) ITALIA

PHONE +39.0442.333219 FAX +39.0442.330694

www.modo10.it

modo@modo10.it

MARCHIO DI PROPRIETÀ: BIANCHINI S.R.L.



Materiali certificati e garantiti dal marchio VERO LEGNO.

All materials are certified and guaranteed by the VERO LEGNO (real wood) trademark.

FOLLOW US:



Le foto devono essere considerate come indicative e non costituiscono impegno per il produttore e/o Distributore. Per ragioni tecniche il produttore si riserva di modificare le caratteristiche dei prodotti senza preavviso.

The pictures are to be considered as illustrative only and are not binding for the Manufacturer and/or the Distributor. For technical reasons, the Manufacturer reserves the right to modify the characteristics of the products without previous notice.

TESSUTI E PELLI
FABRICS AND LEATHER

ECOPELLE | ECOLEATHER H. 140 | 69% PVC, 10% CO, 20% PES, 1% PU | Senza ftalati - phthalate free | PVC made in Italy, ignifugo classe (11M) - Made in Italy PVC, fire resistant class (11M) **CAT. A**

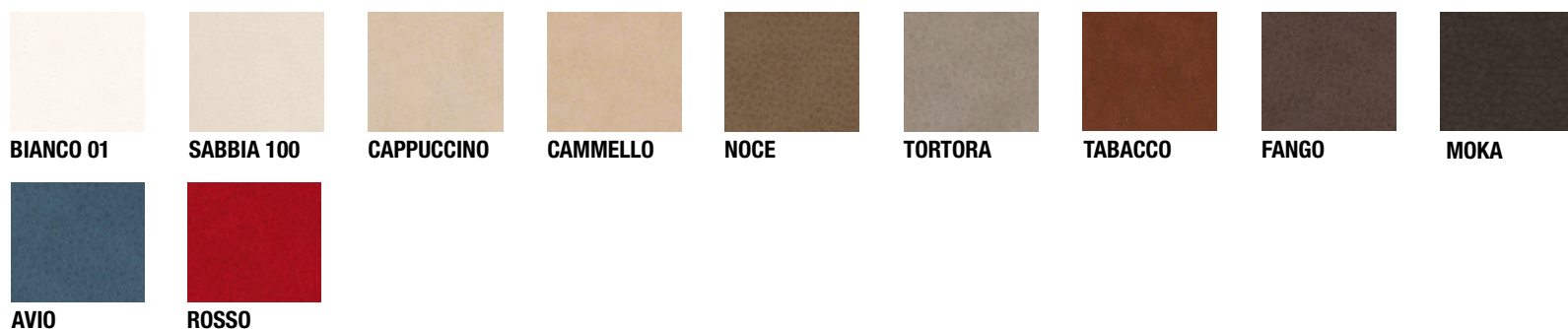

ECONABUK MADE IN ITALY H. 140 | 55% POL, 35% PU, 10% CO | Idrorepellente, facile da pulire - Water repellent, easy to clean **CAT. A**

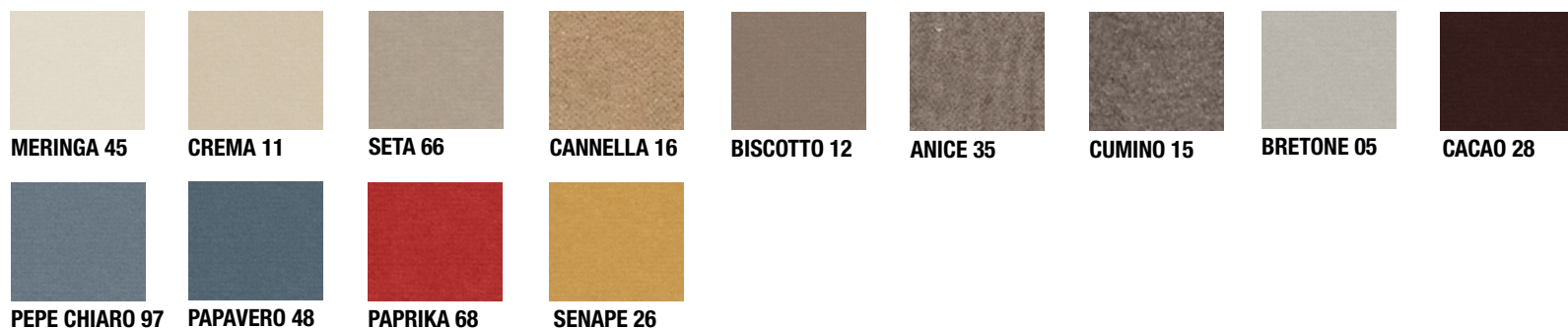

VELLUTO | VELVET MADE IN ITALY H. 140 | 100% PL accoppiato cotone | Idrorepellente - Water repellent | **CAT. B**

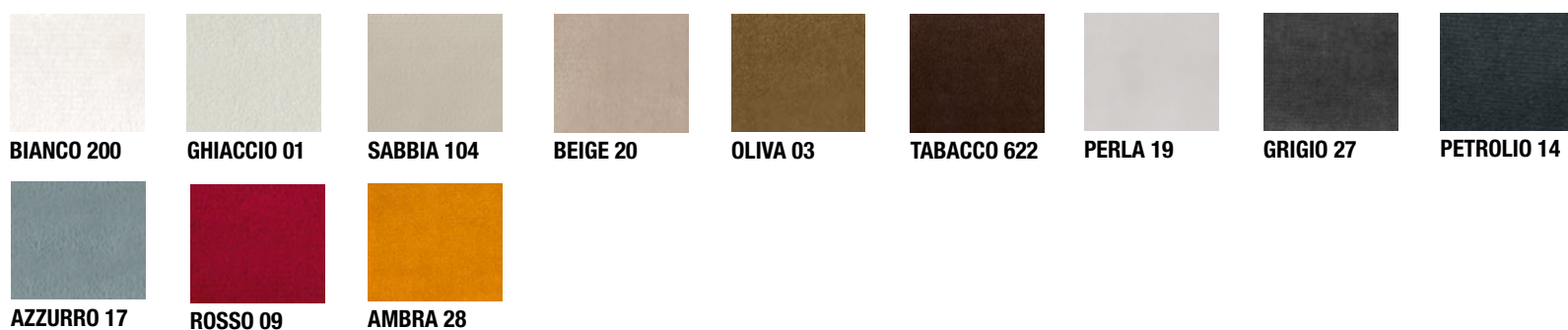

LINO | LINEN MADE IN ITALY H. 140 | 100% LI | Prelavato - Prewashed | **CAT. B**



PELLE | LEATHER MADE IN ITALY **CAT. C**



